

General Information

- Contact Switching Data.....**Web†**
- Surge Suppression Solutions.....**Web†**
- Low Energy Selection Criteria.....**Web†**

General Purpose Relays

- Bulletin 700-HA Tube Base Relay**Page 9-9**
- Bulletin 700-HB Square Base Relay**Page 9-20**
- Bulletin 700-HD Flange Mount Square Base Relay**Page 9-26**
- Bulletin 700-HF Square Base Relay.....**Page 9-29**

Interposing/Isolation Relays

- Bulletin 700-HC Miniature "Ice Cube" Relay**Page 9-34**
- Bulletin 700-HK "Slim Line" Relay**Page 9-39**
- Bulletin 700-HL Terminal Block Relay**Page 9-45**
- Bulletin 700-HP PCB "Pin" Style Relay**Page 9-58**

†Information for this product line is available on the Industrial Controls Catalog website: www.ab.com/catalogs.

Latching Relay

- Bulletin 700-HJ Magnetic Latching Relay ...**Web†**

Power Relays

- Bulletin 700-HG Power Relay.....**Web†**
- Bulletin 700-HHF Flange Mount Power Relay.....**Web†**

DIN Rail Mounted Timing Relays

- Bulletin 700-FE Economy Timing Relay**Page 9-62**
- Bulletin 700-FS High Performance Timing Relay.....**Page 9-66**

Socket Mounted Timing Relays

- Bulletin 700-HNC Miniature Timing Relay ...**Page 9-73**
- Bulletin 700-HNK Ultra-Slim Timing Relay ..**Page 9-78**
- Bulletin 700-HR Dial Timing Relay**Page 9-84**
- Bulletin 700-HS Timing Relay**Web†**
- Bulletin 700-HT Timing Relay.....**Web†**
- Bulletin 700-HV Timing Relay.....**Web†**

Digital Timing/Counting Relays

- Bulletin 700-HX Multifunction Digital Timing Relay**Page 9-96**
- Bulletin 700-HXM Preset Counter/Timing Relay.....**Page 9-106**

Relays, Timers, & Temperature Controllers

Table of Contents

NEMA Heavy-Duty Industrial Relays

- Bulletin 700-P Heavy-Duty Relay.....**Page 9-115**
- Bulletin 700S-P Heavy-Duty Safety Control Relay.....**Page 9-128**
- Bulletin 700-ZP Self-Monitoring Relay Assembly.....**Web‡**
- Bulletin 700-N Industrial Relays.....**Page 9-131**
- Bulletin 700-R, -RM Sealed Switch Relays.**Page 9-136**
- Bulletin 700-RTC Solid-State Timing Relay.**Page 9-141**
- Bulletin 700-PS Solid-State Timing Relays.**Page 9-145**
- Bulletin 849/849A Pneumatic Timing Relay **Web‡**

IEC Industrial Relays

- Bulletin 700-CF Control Relay.....**Page 9-147**
- Bulletin 700S-CF Safety Control Relay.....**Page 9-157**
- Bulletin 700-K Control Relay.....**Page 9-162**

Solid-State Relays

- Bulletin 700-SA Tube Base Relay**Page 9-170**
- Bulletin 700-SC “Ice Cube” Relay.....**Page 9-174**
- Bulletin 700-SF Square Base Relay.....**Page 9-179**
- Bulletin 700-SH “Hockey Puck” Relay**Page 9-183**
- Bulletin 700-SK “Slim Line” Relay**Page 9-191**

Single-Loop Temperature Heater Controllers



- Bulletin 900-TC Digital Temperature Controller.....**Page 9-195**
- Bulletin 900-CONV Interface Converter.....**Page 9-213**
- Bulletin 900 900Builder™ Lite Software.....**Page 9-217**

‡Information for this product line is available on the Industrial Controls Catalog Web site: www.ab.com/catalogs.



Bulletin No.	700-HA	700-HB	700-HD	700-HF
Type	General-Purpose Relay	General-Purpose Relay	General-Purpose Relay	General-Purpose Relay
Features	<ul style="list-style-type: none"> Pin-style terminals Standard ON/OFF flag indicator Electrical schematic on face Clear cover for visual inspection Optional Push-to-test and manual override Optional LED 	<ul style="list-style-type: none"> Blade-style quick connect terminals Standard ON/OFF flag indicator Electrical schematic on face Clear cover for visual inspection Optional push-to-test and manual override Optional LED 	<ul style="list-style-type: none"> Flange-mounted Blade-style quick connection terminals Clear cover for visual inspection 	<ul style="list-style-type: none"> Square-base Plug-in quick connect solder terminals Optional push-to-test and LED
Contact Ratings				
Contact Form	DPDT, 3PDT	DPDT, 3PDT	DPDT, 3PDT	DPDT, 3PDT, 4PDT
Contact Type	Single	Single	Single	Single
Contact Material	AgNi, AgNi + Gold	AgCdO	AgCdO	AgCdO
Max. operating current under resistive load	700-HA: 10 A -HAX: 6 A	15 A	15 A	10 A
Min. permissible load	700-HA 10V 5 mA 700-HAB 5V 5 mA 700-HAX 6V 1mA	10V 10 mA	10V 10 mA	5V 100 mA
Coil Ratings				
Coil Voltage	AC: 6, 12, 24, 48, 110, 120, 208, 230, 240, 277V DC: 6, 12, 24, 36, 48, 60, 80, 110, 125, 140, 220V	AC: 6, 12, 24, 120, 240V DC: 6, 12, 24, 48, 110V	AC: 6V, 12V, 24V, 120V, 208V, 240V DC: 6V, 12V, 24V, 48V, 110V	AC: 6V, 12V, 24V, 120V, 240V DC: 6V, 12V, 24V, 48V, 110V
Permissible Coil Voltage Variation	80...110% of Nominal Voltage at 50 Hz 80...110% of Nominal Voltage at 60 Hz 80...110% of Nominal Voltage at DC	80...110% of Nominal Voltage at 50 Hz 80...110% of Nominal Voltage at 60 Hz 80...110% of Nominal Voltage at DC	80...110% of Nominal Voltage at 50 Hz 80...110% of Nominal Voltage at 60 Hz 80...110% of Nominal Voltage at DC	85...110% of Nominal Voltage at 50 Hz 85...110% of Nominal Voltage at 60 Hz 80...110% of Nominal Voltage at DC
Electrical Ratings				
Dielectric Withstand Voltage	Pole-to-pole: 2000V Contact-to-coil: 2000V Contact-to-frame: 2000V	Pole-to-pole: 2500V Contact-to-coil: 4000V Contact-to-frame: 2500V	Pole-to-pole: 2500V Contact-to-coil: 4000V Contact-to-frame: 2500V	Pole-to-pole: 1500V AC Contact-to-coil: 1500V AC Contact-to-frame: 1500V AC
Electric Service Life (cycles)	100 000 minimum	100 000 minimum	100 000 minimum	200 000 minimum, 500 000 minimum (DPDT)
Reference				
Certifications	CE, cULus, cURus, CSA, Lloyds	CE, cULus, cURus, CSA, Lloyds	CE, UR, CSA, Lloyds	CE, UR, CSA
Socket Cat. No(s).	700-HN100, 700-HN101, 700-HN125, 700-HN126, 700-HN204, 700-HN205	700-HN153, 700-HN154	—	700-HN116, 700-HN138, 700-HN139
Page Number	page 9-9	page 9-20	page 9-26	page 9-29

Bulletin No.	700-HC	700-HK	700-HL	700-HP
Type	Interposing/Isolation Relay	Interposing/Isolation Relay	Interposing/Isolation Relay	Interposing/Isolation Relay
Features	<ul style="list-style-type: none"> Blade-style terminals Standard ON/OFF flag indicator Electrical schematic on face Clear cover for visual inspection Optional push-to-test and manual override Optional LED 	<ul style="list-style-type: none"> Optional pilot light Retainer clip (comes with socket) Low switching capacity Push-to-test & manual override 	<ul style="list-style-type: none"> Ideal for PLC Interfaces Built-in Coil Surge Protection Fully Assembled Relay/Sockets Standard LED Relay or Solid-state Output Optional: Leakage Current Suppression Solution 	<ul style="list-style-type: none"> PCB "Pin Style" mounting 5 mm pin spacing
Contact Ratings				
Contact Form	DPDT, 4PDT	SPDT, DPDT	SPDT 1 N.O. (SSR)	DPDT
Contact Type	Single	Single	Single	Single
Contact Material	AgNi, AgNi + Gold	AgNi, AgNi + Gold	AgSnO	AgNi, AgNi + Gold
Max. operating current under resistive load	10 A (DPDT) 7 A (4PDT)	8 A (DPDT), 16 A (SPDT)	6 A (SPDT), 2 A (SSR DC output), 1 A (SSR AC output)	8 A
Min. permissible load	10V, 10 mA (Gold), 5V, 10 mA or 25V, 2 mA (Silver)	5V 60 mA (Silver), 5V 10 mA (Gold)	12V 6 mA (72 mW) Silver 8V, 2.5 mA (20 mW) Gold	5V 5 mA (50 mW) Gold, 5V 5 mA (300 mW) Silver
Coil Ratings				
Coil Voltage	AC: 6, 12, 24, 120, 240V DC: 6, 12, 24, 48, 110V	AC: 6, 12, 24, 120, 240V DC: 6, 12, 24, 48, 110V	AC: 12, 24, 48, 110, 120, 230, 240V DC: 12, 24, 48, 125, 230, 240V	AC: 6, 12, 24, 120, 240V DC: 6, 12, 24, 48, 110V
Permissible Coil Voltage Variation	80...110% of Nominal Voltage at 50 Hz 80...110% of Nominal Voltage at 60 Hz 80...110% of Nominal Voltage at DC	80...110% of Nominal Voltage at 50 Hz 80...110% of Nominal Voltage at 60 Hz 73...110% of Nominal Voltage at DC	85...110% of Nominal Voltage at 50 Hz 85...110% of Nominal Voltage at 60 Hz 80...110% of Nominal Voltage at DC	80...110% of Nominal Voltage at 50 Hz 80...110% of Nominal Voltage at 60 Hz 73...150% of Nominal Voltage at DC
Electrical Ratings				
Dielectric Withstand Voltage	Pole-to-pole: 1000V Contact-to-coil: 2000V Contact-to-frame: 2000V	Pole-to-pole: 1500V AC Contact-to-coil: 1500V AC Contact-to-frame: 1500V AC	Pole-to-pole: 1000V AC Contact-to-coil: 4000V Contact-to-frame: 1500V	Pole-to-pole: 2000V Contact-to-coil: 5000V
Electric Service Life (cycles)	100 000 minimum	100 000 minimum	100 000 minimum	100 000 minimum
Reference				
Certifications	CE, cULus, cURus, CSA, Lloyds	CE, UL, UR, CSA	CE, cURus, cULus, ABS	CE, cULus, cURus, CSA, Lloyds
Socket Type	700-HN103, 700-HN128, 700- HN104	700-HN121, -HN221 700-HN122, -HN222 700-HN223, -HN224	—	700-HN123, -HN230
Page Number	page 9-34	page 9-39	page 9-45	page 9-58

			
Bulletin No.	700-HG	700-HHF	700-HJ
Type	Power Relay	Power Relay	Magnetic Latching Relay
Features	<ul style="list-style-type: none"> Panel mount with screw terminals Optional magnetic blowouts for switching DC loads Optional snap action switch 	<ul style="list-style-type: none"> Flange mounted Optional LED 	<ul style="list-style-type: none"> Socket mounted Ideal for lighting applications
Contact Ratings			
Contact Form	SPST-N.O.-DM, SPDT, DPST-N.O., DPDT	SPST-NO-DM, DPDT, 3PDT	SPDT, DPDT (Single or Dual Coil)
Contact Type	Single	Single	Single
Contact Material	AgCdO	AgCdO	AgCdO
Max. operating current under resistive load	40 A	20 A (3PDT), 25 A (DPDT), 30 A (SPDT)	10 A
Min. permissible load	10V 50 mA	10V 50 mA 10V 100 mA (3PDT)	10V 50 mA
Coil Ratings			
Coil Voltage	AC: 24V, 120V, 240V, 277V, 480V DC: 12V, 24V, 48V, 110V, 220V, 250V	AC: 24V, 120V, 240V DC: 6V, 12V, 24V	AC: 24V, 120V, 240V DC: 12V, 24V
Permissible Coil Voltage Variation	85...110% of Nominal Voltage at 50 Hz 85...110% of Nominal Voltage at 60 Hz 80...110% of Nominal Voltage at DC	85...110% of Nominal Voltage at 50 Hz 85...110% of Nominal Voltage at 60 Hz 80...110% of Nominal Voltage at DC	85...110% of Nominal Voltage at 50 Hz 85...110% of Nominal Voltage at 60 Hz 80...110% of Nominal Voltage at DC
Electrical Ratings			
Dielectric Withstand Voltage	Pole-to-pole: 2200V AC Contact-to-coil: 2200V AC Contact-to-frame: 2200V AC	Pole-to-pole: 2200V AC Contact-to-coil: 2200V AC Contact-to-frame: 2200V AC	Pole-to-pole: 1500V AC Contact-to-coil: 1500V AC Contact-to-frame: 1500V AC
Electric Service Life (cycles)	100 000 minimum	100 000 minimum	100 000 minimum
Reference			
Certifications	CE, UL, CSA	CE, UR, CSA	CE, UR, CSA
Socket Cat. No(s).	—	—	700-HN153 700-HN154
Page Number	Web†	Web†	Web†

† Information for this product line is available on the Industrial Controls Catalog website: www.ab.com/catalogs.

Bulletin No.	700-FE	700-FS	700-HR52, -HRP, -HRS, -HRT, -HRV	700-HRM/-HRC	700-HRF
Type	DIN Rail Timer	DIN Rail Timer	Multifunction Timer	On-Delay Timer	Twin Timer
Features	<ul style="list-style-type: none"> Only 17.5 mm wide 5 A contact rating Multifunction or single function No additional socket required 	<ul style="list-style-type: none"> Only 22.5 mm wide 8 A contact rating Multifunction or single function No additional socket required Optional: <ul style="list-style-type: none"> Star-delta timing function True off-delay timing function Hazardous location certification 	<ul style="list-style-type: none"> Dial timing relays 5 A contact rating Multiple programmable timing ranges Tube base pin style terminals Multi-voltage inputs Timed contacts and instantaneous contacts Transistor outputs Single function and multi-function 7 different operating modes 	<ul style="list-style-type: none"> Dial timing relays 5 A contact rating Multiple programmable timing ranges Tube base pin-style terminals Multi-voltage inputs Timed contacts and instantaneous contacts Transistor outputs Single function and multi-function 	<ul style="list-style-type: none"> Independent ON and OFF settings 14 time ranges 8-pin models available Dial timing relays UL508
Control Outputs: Time Limit Instantaneous	1 N.O. or SPDT timed	SPDT or DPDT or 2 N.O. + 1 common	DPDT Timed, Transistor SPDT Timed/Instantaneous	DPDT Timed, Transistor SPDT Timed/Instantaneous	DPDT Timed
Operation Modes:	On-delay Off-delay One shot Repeat cycle-pulse Fleeting off-delay Pulse converter	11 Different timing modes	On-Delay Off-Delay One Shot Repeat Cycle Off Start Repeat Cycle On Start Signal On/Off-Delay On-Delay One Shot	On-Delay	Repeat Cycle Off Start Repeat Cycle On Start
Time Range	0.05 s...10 hr	0.05 s...60 hr	0.05 s...300 h	0.05 s...300 h	0.05 s...300 h
Supply Voltage	24V AC/DC 110...240V AC 24...48V AC/DC 24...240V AC	12V DC 24V...48V DC 24V...240V AC	12...48V DC 24...48V AC 100...240V AC 100...125V DC	12...48V DC 24...48V AC 100...240V AC 100...125V DC	12V DC 24V AC/DC 48...125V DC 100...240V AC
Contact Rating at 120V AC	5 A	8 A	5 A	5 A	5 A
Certifications	CE, cULus	CE, cULus	cURus, CE, C-Tick	cURus, CE, C-Tick	cURus, CE, C-Tick
Socket Cat. No(s).	DIN Rail or panel mount	DIN Rail or panel mount	700-HN100 OR 700-HN101 700-HN125 OR 700-HN126	700-HN100 700-HN125	700-HN100 700-HN125
Page Number	page 9-62	page 9-66	page 9-84	page 9-84	page 9-84

Bulletin No.	700-HRY	700-HRQ	700-HNC	700-HNK
Type	Star-Delta Timer	True Off-Delay Timer	Miniature Timer	Ultra-Slim Timer
Features	<ul style="list-style-type: none"> A wide star-time range (up to 120 s) Star-delta transfer time range (up to 0.5 s) UL Recognized 	<ul style="list-style-type: none"> Dial timing relays Long power Off-delay times 11-pin and 8-pin models are available UL Recognized 	<ul style="list-style-type: none"> Four different operating modes DIN Rail mount with socket Pin configuration same as Bulletin 700-HC relay 	<ul style="list-style-type: none"> Ultra-slim timing relay Four different operating modes Three operating voltages DIN Rail mount with socket Pin configuration same as Bulletin 700-HK relay
Control Outputs: Time Limit Instantaneous	SPST (Star, Delta) Timed SPST - NO Instantaneous	DPDT Timed	4PDT	SPDT, DPST-NO
Operation Modes:	Star-Delta	True OFF-delay Timer True OFF-delay Timer w/reset	On-Delay One Shot Repeat Cycle Off Start Repeat Cycle On Start	On-Delay One Shot Repeat Cycle Off Start Repeat Cycle On Start
Time Range	0.5 s...120 s	0.05 s...12 min.	0.1 s...10 h	0.1 s...10 h
Supply Voltage	100...120V AC 200...240V AC	48V DC 24V AC/DC 100...240V AC 100...125V DC	12V DC 24V AC/DC 48...125V DC 100...240V AC	12V DC 24V DC 24V AC
Contact Rating at 120V AC	5 A	5 A	5 A	5 A
Certifications	cURus, CE, C-Tick	cURus, CE, C-Tick	cURus, CSA, CE, C-Tick	cURus, CE, ACA
Socket Cat. No(s).	700-HN100 700-HN125	700-HN100 OR 700-HN101 700-HN125 OR 700-HN126	700-HN103 700-HN128	700-HN121 700-HN122
Page Number	page 9-84	page 9-84	page 9-73	page 9-78

Bulletin No.	700-HT	700-HV	700-HX	700-HXM
Type	Tube Base Timing Relay	Repeat-Cycle Timing Relay	Digital Timer	Digital Counter/Timer
Features	<ul style="list-style-type: none"> Pin-style terminals Single range or fixed timers Available as ON- or OFF-Delays 	<ul style="list-style-type: none"> Pin-style terminals Single-range timer Repeat cycle 	<ul style="list-style-type: none"> Digital timer 5 A contact rating Negative transmissive LCD display 10 functions or modes Environmentally friendly—flash memory, no battery NEMA B300 rated NEMA 4/IP66 DIN Rail or panel mount capable 	<ul style="list-style-type: none"> World's smallest compact preset timer Built-in prescaling for counter operation Finger protection terminal block to meet VDE0106/P100 Panel surface compatible with NEMA 4/IP66 Six-language instruction manual provided Environmentally friendly—flash memory, no battery Negative transmissive LCD display
Control Outputs: Time Limit Instantaneous	DPDT	DPDT	SPDT	SPDT
Timing Operation Modes:	On-Delay Off-Delay	Repeat Cycle	Signal On-Delay 1 and 2 Signal Off-Delay One Shot Repeat Cycle Off Start Repeat Cycle On Start Signal On/Off-Delay Power On-Delay 1 and 2 Twin Timer Cumulative	On-Delay Repeat Cycle Signal Off-Delay One Shot Accumulative On/Off-duty Adjustable-Repeat Cycle Counter Multi Mode
Time Range	0.1 s...30 min.	0.1 s...30 min.	0.05 s...300 h	0...9999 h
Supply Voltage	12V DC 24V DC 24V AC 120V AC 240V AC	24V DC 24V AC 120V AC 240V AC	12...24V DC 24V AC 100...240V AC	24V DC
Contact Rating at 120V AC	10 A	10 A	5 A	5 A
Certifications	UR, UL, CSA, CE	UR, UL, CSA, CE	cURus, CE, C-Tick	cURus, CE, C-Tick
Socket Cat. No(s).	700-HN100 OR 700-HN101 700-HN125 OR 700-HN126	700-HN100 700-HN125	700-HN100 700-HN125	—
Page Number	Web‡	Web‡	page 9-96	page 9-106

9 ‡ Information for this product line is available on the Industrial Controls Catalog website: www.ab.com/catalogs.

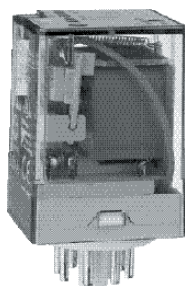

Bulletin 700-HA — Tube Base Relay

- 10 A contact rating
- DPDT, 3PDT
- Pin-style terminals
- Standard ON/OFF flag indicator
- Options: LED, push-to-test and manual override, socket-mounted surge suppressor module, or multi-function timer
- Contact choices: standard silver nickel, bifurcated silver nickel, or bifurcated with gold plating

Table of Contents

Product Selection..... this page

Accessories..... 9-11

Specifications..... 9-9

Approximate Dimensions..... 9-17

Product Selection

Bulletin 700-HA Tube Base Relay with PIN Terminals (Single Contact) — Mechanical ON/OFF Indicator included*

	Description	Contact Rating	Wiring Diagrams		Coil Voltage	Cat. No. * ‡ §
			U.S./Canada	International		
	DPDT 2-pole 2 Form C Single AgNi Contact	10 A B300			6V AC	700-HA32A06
					12V AC	700-HA32A12
					24V AC	700-HA32A24
					120V AC	700-HA32A1
					240V AC	700-HA32A2
					277V AC	700-HA32A27 ➤
					6V DC	700-HA32Z06
					12V DC	700-HA32Z12
					24V DC	700-HA32Z24
					36V DC	700-HA32Z36
					48V DC	700-HA32Z48
					60V DC	700-HA32Z60
					80V DC	700-HA32Z80
					110V DC	700-HA32Z1
					125V DC	700-HA32Z01
140V DC	700-HA32Z3					
220V DC	700-HA32Z2 ➤					
	3PDT 3-pole 3 Form C Single AgNi Contact	10 A B300			6V AC	700-HA33A06
					12V AC	700-HA33A12
					24V AC	700-HA33A24
					120V AC	700-HA33A1
					240V AC	700-HA33A2
					6V DC	700-HA33Z06
					12V DC	700-HA33Z12
					24V DC	700-HA33Z24
					48V DC	700-HA33Z48
					60V DC	700-HA33Z60
					80V DC	700-HA33Z80
					110V DC	700-HA33Z1
					125V DC	700-HA33Z01
					140V DC	700-HA33Z3
					220V DC	700-HA33Z2 ➤

* For Time Module and Surge Suppressor Module, see page 9-12.

‡ LED Option: Add suffix (-4) to the selected Bulletin 700-HA Relay Cat. No., except for the 240V AC Units, add (-4L).

‡ Push-to-test, Manual Override, and LED Option: Add suffix (-3-4) to the selected Bulletin 700-HA Relay Cat. No., except for the 240V AC units, add (-3-4L).

§ Push-to-test and Manual Override option: Add suffix (-3) to the selected Bulletin 700-HA relay.

➤ LED not available for 220V DC and 277V AC coils.

Bulletin 700-HA
General Purpose Relays
 Product Selection

Bulletin 700-HAX Tube Base Relay with PIN Terminals (Bifurcated Contacts with Gold Overlay) — Mechanical ON/OFF Indicator Included*

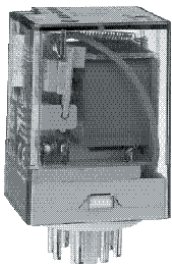
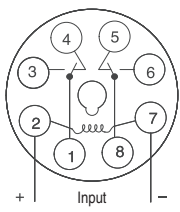
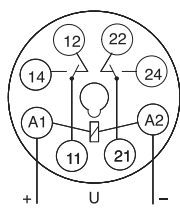
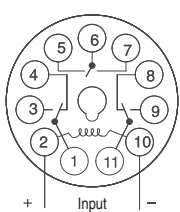
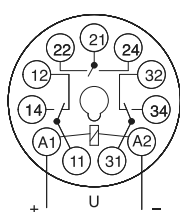
	Description	Contact Rating	Wiring Diagrams		Coil Voltage	Cat. No.*†§			
			U.S./Canada	International					
	DPDT 2-Pole 2 Form C Bifurcated AgNi Contacts with Gold Overlay Sockets	6 A			6V AC	700-HAX2A06			
			12V AC	700-HAX2A12					
			24V AC	700-HAX2A24					
			120V AC	700-HAX2A1					
			240V AC	700-HAX2A2					
			277V AC	700-HAX2A27*‡					
			6V DC	700-HAX2Z06					
			12V DC	700-HAX2Z12					
			24V DC	700-HAX2Z24					
			36V DC	700-HAX2Z36					
			48V DC	700-HAX2Z48					
			110V DC	700-HAX2Z1					
			125V DC	700-HAX2Z01					
			140V DC	700-HAX2Z3					
	3PDT 3-Pole 3 Form C Bifurcated AgNi Contacts with Gold Overlay Sockets	6 A			6V AC	700-HAX3A06			
			12V AC	700-HAX3A12					
			24V AC	700-HAX3A24					
			120V AC	700-HAX3A1					
			240V AC	700-HAX3A2					
			6V DC	700-HAX3Z06					
			12V DC	700-HAX3Z12					
			24V DC	700-HAX3Z24					
			48V DC	700-HAX3Z48					
			110V DC	700-HAX3Z1					
			125V DC	700-HAX3Z01					
			140V DC	700-HAX3Z3					

* For Time Module and Surge Suppressor Module, see page 9-12.







‡ LED Option: Add suffix (-4) to the selected Bulletin 700-HAX Relay Cat. No., except for the 240V AC Units, add (-4L).

† Push-to-test and LED Option: Add suffix (-3-4) to the selected Bulletin 700-HAX Relay Cat. No., except for the 240V AC units, add (-3-4L).

§ Push-to-test and Manual Override option: Add suffix (-3) to the selected Bulletin 700-HA relay.

* LED not available.

Accessories

	Description	Pkg. Qty.	Cat. No.
 Cat. No. 700-HN100	Screw Terminal Tube Base Socket — Panel or DIN Rail Mounting; Guarded Terminal Construction. 8-Pin for use with DPDT Bulletin 700-HA Relays, -HX Timing Relays, -HT (On-Delay) and -HRM, -HRC and -HV (Repeat Cycle) Timing Relays.	10	700-HN100
 Cat. No. 700-HN125	Screw Terminal Tube Base Socket — Panel or DIN Rail Mounting; Open Style Construction. 8-Pin for use with DPDT Bulletin 700-HA Relays, -HT (On-Delay) and -HRM, -HRC, and -HV (Repeat Cycle) Timing Relays. No retainer clip required.	10	700-HN125
 Cat. No. 700-HN101	Screw Terminal Tube Base Sockets — Panel or DIN Rail Mounting; Guarded Terminal Construction. 11-pin for use with 3PDT 700-HA relays.	10	700-HN101
 Cat. No. 700-HN126	Screw Terminal Tube Base Sockets — Panel or DIN Rail Mounting; Open Style Terminal Construction. 11-pin for use with 3PDT 700-HA relays. No retainer clip required.	10	700-HN126
 Cat. No. 700-HN205	8-Pin Socket — Can Be Used With or Without Timing Attachment or Surge Suppressor Screw Terminal Tube Base Sockets — panel or DIN Rail mounting. Guarded terminal construction. Used with DPDT Bulletin 700-HA Relays.	10	700-HN204
	11-Pin Socket — Can Be Used With or Without Timing Module or Surge Suppressor. Screw Terminal Tube Base Sockets — panel or DIN Rail mounting. Guarded terminal construction. Used with 3PDT Bulletin 700-HA relays.	10	700-HN205
 Cat. No. 199-DR1	DIN (#3) symmetrical hat rail 35 x 7.5 x 1 m	10	199-DR1

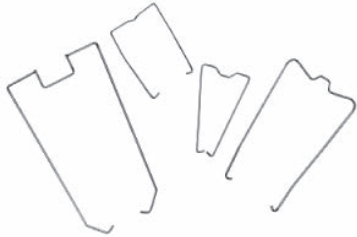
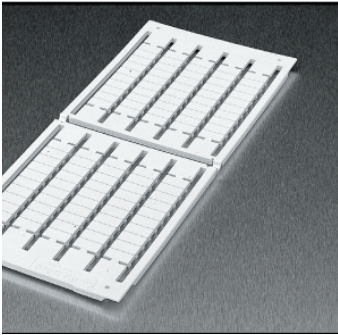
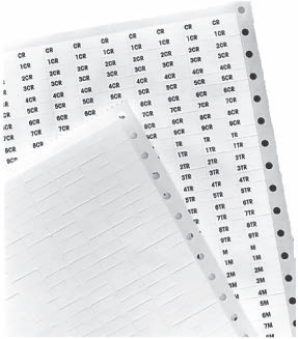
	Description	Pkg. Qty.	Cat. No.						
 <p style="text-align: center;">Sample Retainer Clips</p>	<p>Retainer Clip for Cat. Nos. 700-HN100, -HN101, -HN204, and -HN205 Sockets with Bulletin 700-HA Relays* Secures relay in socket.</p>	10	700-HN157						
 <p style="text-align: center;">Snap-in markers</p>	<p>Relay Identification Snap-in Markers† Snap-in markers fit on top of product covers. Squares slip into molded slot on top of product cover.</p>	5	<table border="1" style="width: 100%; border-collapse: collapse;"> <tr><td style="text-align: center;">1492-MS5X12</td></tr> <tr><td style="text-align: center;">1492-MS6X9</td></tr> <tr><td style="text-align: center;">1492-MS6X12</td></tr> <tr><td style="text-align: center;">1492-MS8X9</td></tr> <tr><td style="text-align: center;">1492-MS8X12</td></tr> <tr><td style="text-align: center;">1492-MP-Blank</td></tr> </table>	1492-MS5X12	1492-MS6X9	1492-MS6X12	1492-MS8X9	1492-MS8X12	1492-MP-Blank
1492-MS5X12									
1492-MS6X9									
1492-MS6X12									
1492-MS8X9									
1492-MS8X12									
1492-MP-Blank									
	<p>Pre-Printed Identification Tags — contains 10 sheets of pre-printed and blank tags. Each sheet contains 13 sets of the markings CR...9CR, TR...9TR, M...9M, F, R, 1S, and 117 blank tags. Tags are peel-off with sticky backing for easy placement on relays.</p> <p>Blank Identification Tags — contains 10 sheets of blank identification tags for customer specialized printing. Each sheet contains 546 blank tags. Tags are peel-off with sticky backing for easy placement on relays.</p>	10	700-N40						

* See Bulletin 700-HA Relay, Socket, and Retainer Clip Reference Chart below.

† For pre-printed marker cards, turn to the following 1492 sections (tab 12, under IEC Terminal Block Accessories): 1492-SM5X12_, 1492-SM6X9_, 1492-SM8X9_, 1492-SM8X12_, 1492-MP_.

Relay Type	Socket	Retainer Clip
700-HA32 700-HAB2 700-HAX2	700-HN100 700-HN125 700-HN204 700-HN200	700-HN157 Not Required§ 700-HN157 700-HN157
700-HA33 700-HAB3 700-HAX3	700-HN201 700-HN101 700-HN126 700-HN205	700-HN157 700-HN157 Not Required§ 700-HN157

§ Design of these sockets holds the relays securely and does not require retainer clips.

Bulletin 700-HA
General Purpose Relays
Specifications

Cat. No. 700-HA...			
Electrical Ratings			
Pilot Duty Rating*	NEMA B300		
Rated Thermal Current (I_{th})	HA = 10 A – 120V, 240V HAX = 6 A – 120V, 240V		
Rated Insulation Voltage (U _i)	250V IEC – 300V UL/CSA		
Contacts	Inductive	Make	Break
		▶][◀	◀][▶
	120V AC	30 A	3 A
	240V AC	15 A	1.5 A
	General Purpose	10 A, 240V AC	
	Resistive	10 A, 30V DC	
Min. Low Energy Permissible Load	HA = 10V, 5 mA HAX = 5V, 2 mA		
Permissible Coil Voltage Variation	Pickup: 80...110% of Nominal Voltage at 50 Hz 80...110% of Nominal Voltage at 60 Hz 80...110% of Nominal Voltage at DC		
Coil Consumption ±10%	AC Coils	50 Hz	60 Hz
	Inrush	3.3 VA	2.85 VA
	Sealed	2.2 VA	1.9 VA
	DC Coils	1.3 W	
Must Dropout Voltage	20% of nominal V AC 10% of nominal V DC		
Max. Contact Resistance	50 MΩ (700-HA and 700-HAB) 30 MΩ (700-HAX)		
Design Specification/Test Requirements			
Electrical			
Pole-to-Pole	1000V		
Contact to Coil	3600V		
Contact to Frame	4000V		
Electrical Life (Operating)	100 000 min.		
Mechanical			
Degree of Protection (Open Type) IEC 529	IP 40		
Mechanical Life Cycles (AC/DC)	> 20 x 10 ⁶ / 50 x 10 ⁶		
Switching Frequency Operations	3600/HR		
Coil Voltages	See Product Selection		
Operating Time	Max. Pickup	10 ms	
	Max. Dropout	10 ms	
Maximum Operating Rate	4 Ops/s		
Vibration	Endurance	5 G	
	Operational	2.5 G	
Shock	Endurance	50 G	
	Operational	9 G	
Environmental			
Temperature	Operating	AC/DC	-40...+70 °C
	Storage	AC/DC	-40...+100 °C
Altitude	2000 m (6560 ft)		
Construction			
Insulating Material	Molded High-Dielectric Material		
Enclosure	Transparent Dust Cover		
Contact Material	700-HA:	10 A– AgNi	
	700-HAX:	6 A–Bifurcated/Gold Plating AgNi	
Terminal Markings on Socket	In accordance with EN50 0005		
Sockets	8-Pin Socket — 700-HN100, -HN125, -HN204 11-Pin Socket — 700-HN101, -HN126, -HN205		
Certifications	cURus Recognized (File No. E3125, Guide NLDX2/NLDX8), cULus Listed when used with Bulletin 700-HN sockets noted above (File No. E3125, Guide NLDX/NLDX7), CE Marked, CSA Certified, UR Certified (File 229473)		
Standards	UL508, CSA C22.2 No. 14, EN 61810-1, EN 60255-23		

* Performance Data – See this catalog, Important- 3.

* NEMA Rating Chart is in publication 700-SG003*



700-HA Relay Performance Graphs

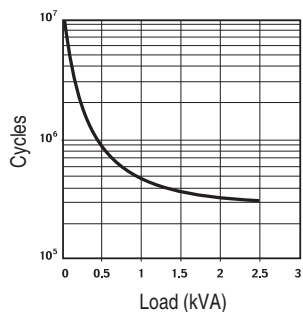

Contact life vs. AC1 load at 1,800 cycles/h

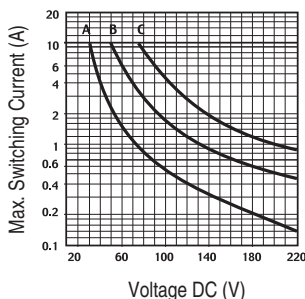

Breaking capacity for DC1 load at 1,800 cycles/h.

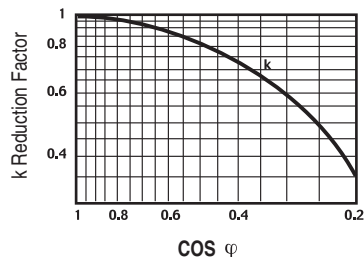

Load reduction factor vs. $\cos \phi$

A = load applied to one contact
B = load applied to two contacts in series
C = load applied to three contacts in series

Time Module Cat. No. 700-HT3		
Electrical Ratings		
Operating Voltage Range	12...240V AC (50/60 Hz) 12...240V DC	
Power Consumption	0.1 W (12V) 1.0 W (230V)	
Mechanical		
Degree of Protection of Input (B1) Terminal	IP 20 (Guarded Terminal)	
Input Terminal Wire Range	1.0 x 0.2 mm ² ...2.5 mm ² (24 AWG...14 AWG) 2.0 x 0.2 mm ² ...1.5 mm ² (24 AWG...16 AWG)	
Input Terminal Torque Range	0.45...0.8 Nm (4...7 lb-in.)	
LED Indicator	Red	
Repeat Accuracy*	±1%	
Recovery Time	<50 ms	
Selectable Timing Ranges	Three DIP switches, seven ranges (set from 5...100% of range): 1 s, 10 s, 100 s, 10 min, 100 min, 10 h, 100 h	
Selectable Timing Modes	Three DIP switches, eight modes: 1. Power On-Delay 2. Power On One-Shot 3. Power On Repeat Cycle, On Start 4. Signal On-Delay and Signal Off-Delay 5. Signal Off-Delay 6. Signal On-One-Shot 7. Signal Off-One-Shot 8. Signal On and Signal Off Watchdog Monitor	
Adjustable Trimmer Scale Accuracy	±5% of Time Range	
Environmental		
Temperature	Operating	-20 °C...+50 °C (-4 °F...+122 °F)
	Storage	-55 °C...+85 °C (-67...+185 °F)
Altitude	2000 m (6560 ft)	
Construction		
Enclosure	Gray Plastic Housing	
Mounting with Socket Only	8- or 11-Pin Socket with Module Plug	
Sockets	700-HN204 (8-Pin with Plug) 700-HN205 (11-Pin with Plug)	
Certifications	cURus Recognized (File No. E14843, Guide NRNT2/NRNT8), CE Marked	
Standards	UL508, CSA C22.2 No. 14, EN 61810-1, EN 60255-23	

* Performance Data - See this publication, Important 3.
 * At constant voltage and temperature.

Timing Charts, Cat. No. 700-HT3 Multi-Function Time Module (t = Time Range 0.05 s...100 h)

Terms:

U is Power Input

R is Relay Output

S Signal, **+A1** Socket, **B1** Timer

t is the resulting Time Delay (Red LED)

1. Power On-Delay

Apply power (U) to timer. Relay contacts (R) change state after time delay (t) is complete. Contacts return to their shelf state when power is removed. Terminal B1 is not used in this mode.



2. Power On One-Shot

Apply power (U) to timer. Relay contacts (R) change state immediately and the time delay (t) begins. When the time delay (t) is complete, contacts return to their shelf state. Contacts return to their shelf state when power is removed. Terminal B1 is not used in this mode.



3. Power On Repeat Cycle, On Start

Apply power (U) to timer. Relay contacts (R) change state immediately and the time delay (t) begins. When the time delay (t) is complete, the contacts return to their shelf state for time delay (t) (time on = time off). This cycle will repeat until the power is removed. Terminal B1 is not used in this mode.

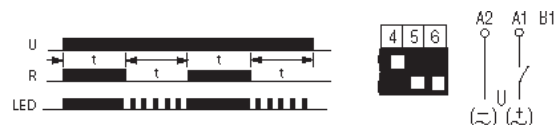

4. Signal On-Delay and Signal Off-Delay

Apply power (U) to timer. When the signal (S) is closed the time delay (t) begins, after the time delay is complete the relay contacts (R) change state. Opening the signal starts the time delay, after the time delay is complete the contacts return to their shelf state. If the signal is closed or opened before the time delay is complete, the time delay is reset. Contacts return to their shelf state when power is removed.



Cat. No. 700-HT3 Timing Modes, Time Description, Timing Charts, and DIP Switch Selections

5. Signal Off-Delay

Apply power (U) to timer. When the signal (S) is closed, the relay contacts (R) change state immediately. When the signal is opened, the time delay (t) begins. If the signal is closed before the time delay is complete, the time delay is reset and the relay remains energized. When the time delay is complete, the contacts return to their shelf state. Contacts return to their shelf state when power is removed.

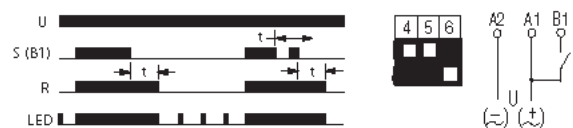

6. Signal On One-Shot

Apply power (U) to timer. When the signal (S) is closed, the relay contacts (R) change state immediately and the time delay (t) begins. After the time delay begins, opening or closing the signal will not reset the time delay. When the time delay is complete, the contacts return to their shelf state. Contacts return to their shelf state when power is removed.



7. Signal Off One-Shot

Apply power (U) to timer. When the signal (S) is closed and then opened, the relay contacts (R) change state immediately and the time delay (t) begins. After the time delay begins, opening or closing the signal will not reset the time delay. When the time delay is complete, the contacts return to their shelf state. Contacts return to their shelf state when power is removed.



8. Signal On and Signal Off Watchdog Monitor

Apply power (U) to timer. When the signal (S) is closed, the relay contacts (R) energize immediately and the time delay (t) begins. If the signal is opened before the time delay is complete, the relay remains energized and the time delay is reset. When the time delay is complete the contacts return to their shelf state. If the signal is opened after the time delay is complete, the relay contacts energize immediately and the same time delay begins. Continuous cycling of the signal at a rate that is faster than the time delay will cause the relay contacts to remain energized. Contacts return to their shelf state when power is removed.

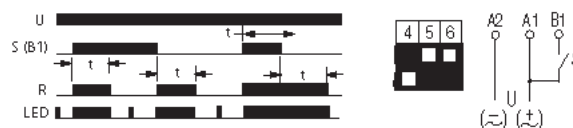

Approximate Dimensions

Approximate Dimensions are shown in millimeters (inches). Approximate Dimensions are not intended to be used for manufacturing purposes.

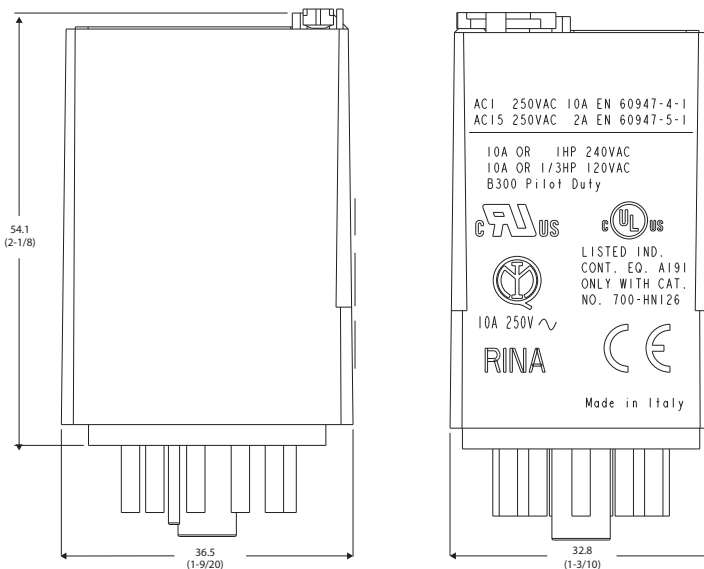

Bulletin 700-HA Relay

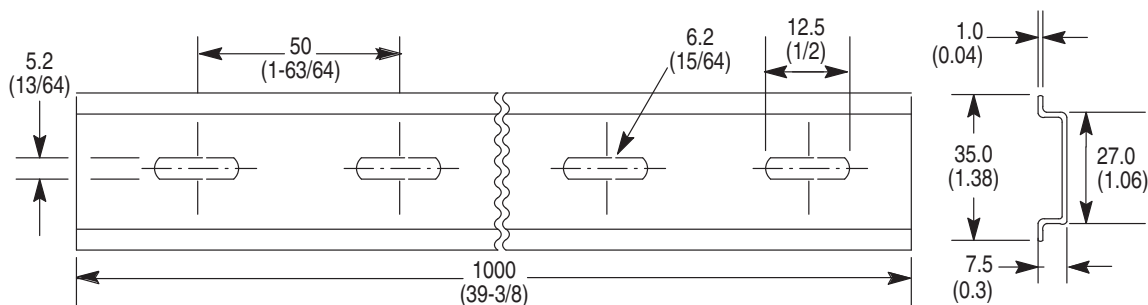

Cat. No. 199-DR1 DIN Mounting Rail Series B
Cat. No. 199-DR4 DIN Mounting Rail Series B Has No Mounting Holes

Cat. No.	A	B	C	D	Approx. Shipping Wt.
199-DR1	35 (1-3/8)	27 (1-1/16)	7.5 (19/64)	1.02 (1/64)	1.85 kg (4.07 lb) (10/pkg)
199-DR4	35 (1-3/8)	27 (1-1/16)	15 (19/32)	2.3 (3/32)	3.68 kg (8 lb) (5/pkg)

Bulletin 700-HA
General Purpose Relays
 Approximate Dimensions

Approximate Dimensions are shown in millimeters (inches). Approximate Dimensions are not intended to be used for manufacturing purposes.

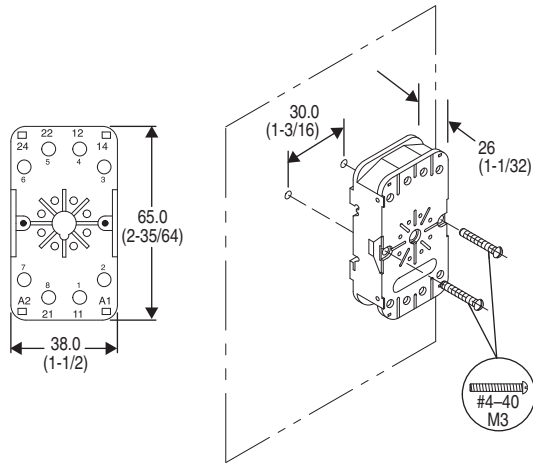

Cat. No. 700-HN100

Panel Mounting

Wire Size: $2 \times 2.5 \text{ mm}^2$
 Single Wire – Up to #12 AWG
 Double Wire – $2 \times 2.5 \text{ mm}^2$ (#2-14 AWG... #2-20 AWG)
 (Either Solid or Stranded)
 Strip Length: 9 mm (3/8 in.) – Torque: 0.8 N•m (7 lb•in)

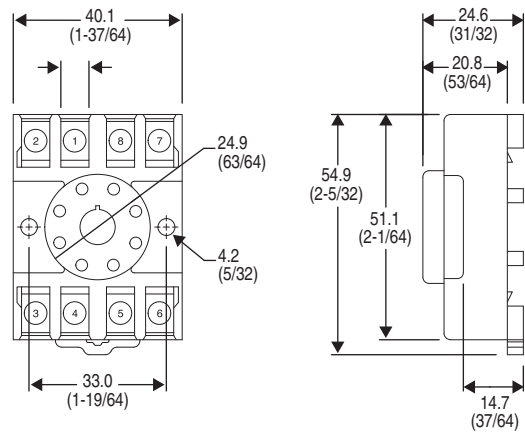

Cat. No. 700-HN125

Wire Size: $2 \times 2.5 \text{ mm}^2$
 Single Wire – Up to #12 AWG
 Double Wire – $2 \times 2.5 \text{ mm}^2$ (#2-14 AWG... #2-20 AWG)
 (Either Solid or Stranded)
 Strip Length: 9 mm (3/8 in.) – Torque: 0.8 N•m (7 lb•in)

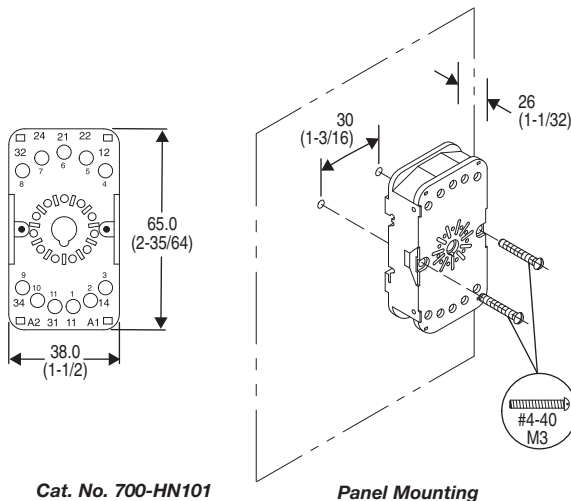

Cat. No. 700-HN101

Panel Mounting

Wire Size: $2 \times 2.5 \text{ mm}^2$
 Single Wire – Up to #12 AWG
 Double Wire – $2 \times 2.5 \text{ mm}^2$ (#2-14 AWG... #2-20 AWG)
 (Either Solid or Stranded)
 Strip Length: 9 mm (3/8 in.) – Torque: 0.8 N•m (7 lb•in)

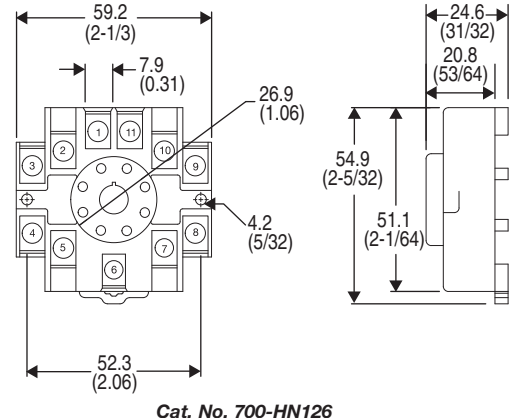

Cat. No. 700-HN126

Wire Size: $2 \times 2.5 \text{ mm}^2$
 Single Wire – Up to #12 AWG
 Double Wire – $2 \times 2.5 \text{ mm}^2$ (#2-14 AWG... #2-20 AWG)
 (Either Solid or Stranded)
 Strip Length: 9 mm (3/8 in.) – Torque: 0.8 N•m (7 lb•in)

Approximate Dimensions are shown in millimeters (inches). Approximate Dimensions are not intended to be used for manufacturing purposes.

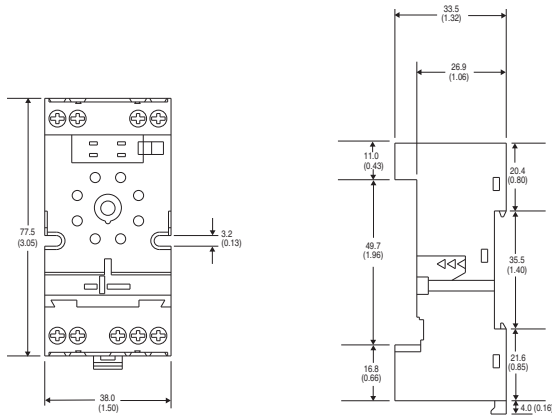

Cat. No. 700-HN204

Wire Size: $2 \times 2.5 \text{ mm}^2$
 Single Wire – Up to #12 AWG
 Double Wire – $2 \times 2.5 \text{ mm}^2$ (#2–14 AWG... #2–20 AWG)
 (Either Solid or Stranded)
 Strip Length: 9 mm (3/8 in.) – Torque: 0.8 N•m (7 lb•in)

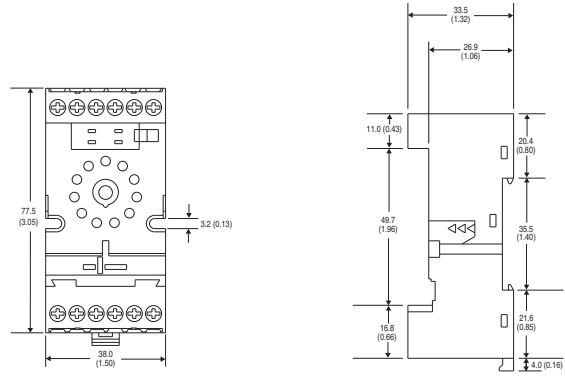

Cat. No. 700-HN205

Wire Size: $2 \times 2.5 \text{ mm}^2$
 Single Wire – Up to #12 AWG
 Double Wire – $2 \times 2.5 \text{ mm}^2$ (#2–14 AWG ...#2–20 AWG)
 (Either Solid or Stranded)
 Strip Length: 9 mm (3/8 in.) – Torque: 0.8 N•m (7 lb•in)

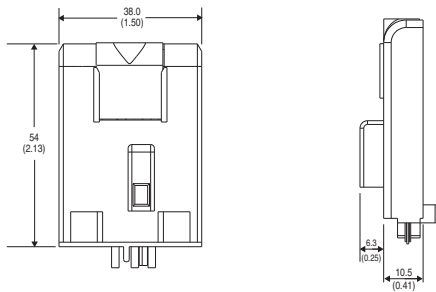

Cat. No. 700-HT3

Wire Size: $2 \times 1.5 \text{ mm}^2$ (#2 – 16 AWG...#1–20 AWG)
 (Either Solid or Stranded)
 Strip Length: 9 mm (3/8 in.) – Torque: 0.8 N•m (7 lb•in)



Bulletin 700-HB — Square Base Relay

- 15 A contact rating
- DPDT, 3PDT
- Blade-style quick connect terminals
- Standard ON/OFF flag indicator
- Options: LED, push-to-rest, and manual override
- Faston 187 (4.8 x 0.5 mm)

Table of Contents

Product Selection this page

Accessories..... 9-22

Specifications..... 9-23





























Approximate Dimensions..... 9-25

Product Selection

Bulletin 700-HB Square Base Relay with Blade Style Quick Connect/Solder Terminations — Mechanical ON/OFF Indicator Included

	Description	Contact Rating	Wiring Diagrams		Coil Voltage	Cat. No.*§
			U.S./Canada	International		
 DPDT 2-Pole 2 Form C Single AgCdO Contact Sockets	15 A B300	 + Input -	 + U -	6V AC	700-HB32A06	
				12V AC	700-HB32A12	
				24V AC	700-HB32A24	
				120V AC	700-HB32A1	
				240V AC	700-HB32A2	
				6V DC	700-HB32Z06	
				12V DC	700-HB32Z12	
				24V DC	700-HB32Z24	
				48V DC	700-HB32Z48	
				110V DC	700-HB32Z1	
3PDT 3-Pole 3 Form C Single AgCdO Contact Sockets	15 A B300	 + Input -	 + U -	6V AC	700-HB33A06	
				12V AC	700-HB33A12	
				24V AC	700-HB33A24	
				120V AC	700-HB33A1	
				240V AC	700-HB33A2	
				6V DC	700-HB33Z06	
				12V DC	700-HB33Z12	
				24V DC	700-HB33Z24	
				48V DC	700-HB33Z48	
				110V DC	700-HB33Z1	

* LED Option: Add suffix (-4) to the selected Bulletin 700-HB Relay Cat. No., except for the 240V AC Units, add (-4L).
 § Push-to-test, Manual Override, and LED Option: Add suffix (-3-4) to the selected Bulletin 700-HB Relay Cat. No., except for the 240V AC units, add (-3-4L).
 § Push-to-test and Manual Override option: Add suffix (-3) to the selected Bulletin 700-HB relay.

	Description	Pkg. Qty.	Cat. No.																					
	Diode Surge Suppressor Voltage Range: 6...220V DC used with 700-HN153 socket	10	700-ADR																					
	Diode with LED Surge Suppressor Voltage Range: 6...24V DC used with 700-HN153 socket	10	700-ADL1R																					
	Diode with LED Surge Suppressor Voltage Range: 28...60V DC used with 700-HN153 socket	10	700-ADL2R																					
	Diode with LED Surge Suppressor Voltage Range: 110...220V DC used with 700-HN153 socket	10	700-ADL3R																					
	Varistor with LED Surge Suppressor Voltage Range: 6...24V AC used with 700-HN153 socket	10	700-AV1R																					
	Varistor with LED Surge Suppressor Voltage Range: 110...240V AC used with 700-HN153 socket	10	700-AV3R																					
	RC Surge Suppressor Voltage Range: 6...24V AC/DC used with 700-HN153 socket	10	700-AR1																					
	RC Surge Suppressor Voltage Range: 110...240V AC/DC used with 700-HN153 socket	10	700-AR2																					
	Timing Module On-Delay or One-Shot selectable voltage range: 12...24V AC/DC used with sockets that accept plug-in accessory modules.	1	700-AT3																					
	Timing Module On-Delay or One-Shot selectable voltage range: 110...125V AC used with sockets that accept plug-in accessory modules.		700-AT3A1																					
	Timing Module On-Delay or One-Shot selectable voltage range: 230...240V AC used with sockets that accept plug-in accessory modules.		700-AT3A2																					
 Cat. No. 700-HT3	Multi-Function Multi-Range Time Module Voltage range 12...240V AC 50/60 Hz and 12...240V DC, with a voltage variation of 85...110%. Repeat accuracy of ±1%. Reset time <50 ms. For use with 700-HN153 socket. Refer to page 9-23 for Specifications. Eight Timing Modes Seven Timing Ranges:	1	700-HT3																					
	<table border="0"> <tr> <td>1. 1 s</td> <td>0.05 s...1 s</td> <td></td> </tr> <tr> <td>2. 10 s</td> <td>0.5 s...10 s</td> <td></td> </tr> <tr> <td>3. 100 s</td> <td>5 s...100 s</td> <td></td> </tr> <tr> <td>4. 10 min.</td> <td>0.5 min...10 min</td> <td></td> </tr> <tr> <td>5. 100 min.</td> <td>5 min...100 min</td> <td></td> </tr> <tr> <td>6. 10 hours</td> <td>0.5 hr...10 hr</td> <td></td> </tr> <tr> <td>7. 100 hours</td> <td>5 hr...100 hr</td> <td></td> </tr> <tr> <td>8. LED Indicator</td> <td></td> <td></td> </tr> </table>			1. 1 s	0.05 s...1 s		2. 10 s	0.5 s...10 s		3. 100 s	5 s...100 s		4. 10 min.	0.5 min...10 min		5. 100 min.	5 min...100 min		6. 10 hours	0.5 hr...10 hr		7. 100 hours	5 hr...100 hr	
1. 1 s	0.05 s...1 s																							
2. 10 s	0.5 s...10 s																							
3. 100 s	5 s...100 s																							
4. 10 min.	0.5 min...10 min																							
5. 100 min.	5 min...100 min																							
6. 10 hours	0.5 hr...10 hr																							
7. 100 hours	5 hr...100 hr																							
8. LED Indicator																								
 Cat. No. 700-HN153	Screw Terminal Socket — Panel or DIN Rail Mounting. Guarded Terminal Construction 11-blade socket for use with Bulletin 700-HB relays. This socket has coil and contact separation as well as the ability to use optional plug-in modules (700-A__ accessories, LED, surge suppression, timing modules).	10	700-HN153																					
 Cat. No. 700-HN154	Screw Terminal Base Socket — Panel or DIN Rail Mounting. Open Style Construction 11-blade for use with Bulletin 700-HB relays.	10	700-HN154																					
 Cat. No. 199-DR1	DIN (#3) symmetrical hat rail 35 x 7.5 x 1 m	10	199-DR1																					
 Sample Retainer Clips	Retainer Clip for Cat. No. -HN154 open terminal socket with 700-HB relays* Secures relay in socket. Order must be for 10 clips or multiples of 10.	10	700-HN156																					
	Retainer Clip for Cat. No. 700-HN153 Sockets with 700-HB Relays* . Secures relay in socket. Order must be for 10 clips or multiples of 10.	10	700-HN158																					

* See Bulletin 700-HB square base relay socket and retainer clip reference chart (see page 9-22).

Bulletin 700-HB
General Purpose Relays
 Accessories

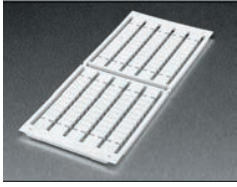
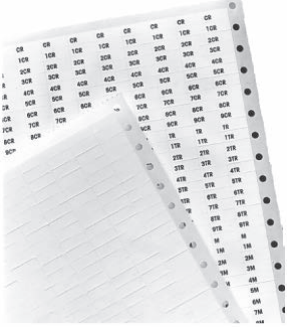
	Description	Pkg. Qty.	Cat. No.
 <p>Snap-in markers</p>	<p>Relay Identification Snap-in Markers† Snap-in markers fit on top of product covers. The following are blank cards. Squares slip into molded slot on top of product covers.</p>	100	1492-MS5X12 1492-MS6X9 1492-MS6X12 1492-MS8X9 1492-MS8X12 1492-MP-Blank
	<p>Pre-Printed Identification Tags — contains 10 sheets of pre-printed and blank tags. Each sheet contains 13 sets of the markings CR...9CR, TR...9TR, M...9M, F, R, 1S, and 117 blank tags. Tags are peel-off with sticky backing for easy placement on relays.</p> <p>Blank Identification Tags — contains 10 sheets of blank identification tags for customer specialized printing. Each sheet contains 546 blank tags. Tags are peel-off with sticky backing for easy placement on relays.</p>	10	700-N40
		10	700-N41

† For pre-printed marker cards, turn to the following 1492 sections of publication A115: 1492-MS5X12_, 1492-MS6X9_, 1492-MS8X9_, 1492-MS8X12_, 1492-MP_.

Relay Type	Socket Cat. No.	Retainer Clip Cat. No.
700-HB	700-HN153 700-HN154	700-HN158 700-HN156

Specifications

Cat. No. 700-HB...						
Electrical Ratings						
Pilot Duty Rating*	NEMA B300					
Rated Thermal Current (I_{th})	15 A – 120V, 240V					
Rated Insulation Voltage (U)	250V IEC-300V UL/CSA					
Contacts	Inductive	Make		Break		Hp
		▶ ◀		◀ ▶		
		2 -Pole	3 -Pole	2 -Pole	3 -Pole	
	120V AC	60 A	30 A	6 A	3 A	3/4
	240V AC	30 A	15 A	3 A	1.5 A	2
	General Purpose	15 A, 240V AC				
	Resistive	15 A, 30V DC				
Min. Low Energy Permissible Load	1000 mW (10V, 10 mA)					
Permissible Coil Voltage Variation	80...110% of Nominal Voltage at 50 Hz					
	80...110% of Nominal Voltage at 60 Hz					
	80...110% of Nominal Voltage at DC					
Coil Consumption ±10%	AC Coils	50 Hz		60 Hz		
	Inrush	3.3 VA		2.85 VA		
	Sealed	2.2 VA		1.9 VA		
	DC Coils	1.3 W				
Max. Allowable Leakage	25% of VA					
	10% of W					
Max. Contact Resistance	50 mΩ					
Design Specification/Test Requirements Electrical						
Dielectric Withstand Voltage						
Pole-to-Pole	1500V					
Contact to Coil	6000V					
Contact to Frame	4000V					
Mechanical						
Degree of Protection (Open Type) IEC 529	IP 40					
Mechanical Life Cycles (AC/DC)	> 10 x 10 ⁶ /30 x 10 ⁶					
Switching Frequency Operations	3600/HR					
Coil Voltages	See Overview/Product Selection					
Operating Time (ms)	Pickup	20 ms				
	Dropout	4 ms				
Maximum Operating Rate	4 Ops/s					
Vibration	Endurance	5 G				
	Operational	1.5 G				
Shock	Endurance	50 G				
	Operational	15 G				
Environmental						
Temperature	Operating	AC/DC		-40...+70 °C		
	Storage	AC/DC		-40...+100 °C		
Altitude	2000 m (6560 ft)					
Construction						
Insulating Material	Molded High Dielectric Material					
Enclosure	Transparent Dust Cover					
Contact Material	AgCdO					
Terminal Markings on Socket	In accordance with EN50 0005					
Sockets	700-HN153, -HN154					
Certifications	cURus Recognized (File No. E3125, Guide NLDX2/NLDX8), cULus Listed when used with Bulletin 700-HN sockets noted above (File No. E3125, Guide NLDX/NLDX7), CE Marked, CSA Certified, UR Certified (File No. 229473)					
Standards	UL508, CSA C22.2 No. 14, EN 61810-1, EN 60255-23					

* Performance Data – See this catalog, Important- 3.

* NEMA Rating Chart is in publication 700-SG003*

Technical Data

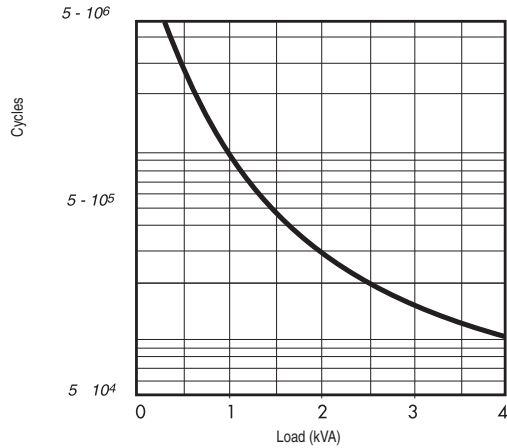

Contact life vs AC1 load at 600 cycles/h.

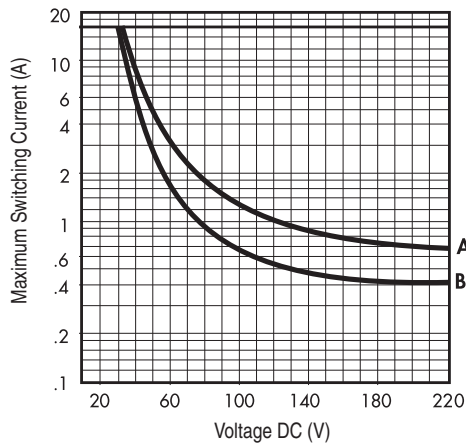

Breaking capacity for DC1 load at 600 cycles/h.
 Load applied to 1 contact.
 A = for N.O. types
 B = other types

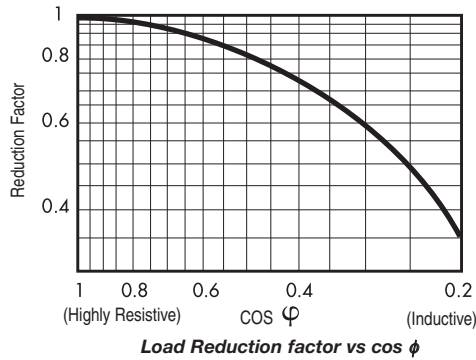

Load Reduction factor vs cos ϕ

9

Approximate Dimensions

Approximate Dimensions are shown in millimeters (inches). Approximate Dimensions are not intended to be used for manufacturing purposes.

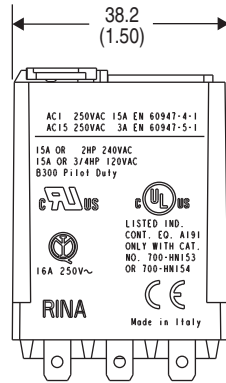
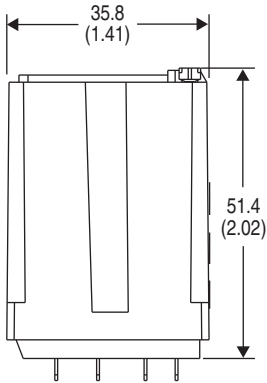

Bulletin 700-HB Relay

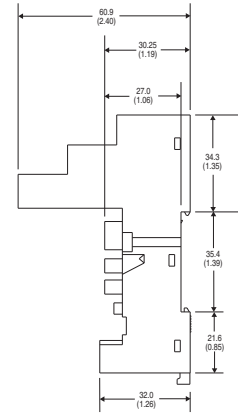
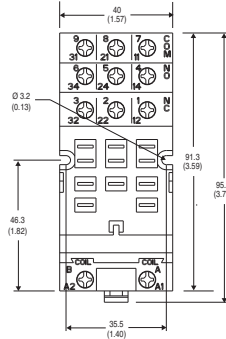

Cat. No. 700-HN153
Wire Size: 2 x 2.5 mm²
Single Wire – Up to #12 AWG
Double Wire – 2 x 2.5 mm² (#2–14 AWG... #2–20 AWG)
(Either Solid or Stranded)
Strip Length: 9 mm (3/8 in.) – Torque: 0.8 N•m (7 lb•in)

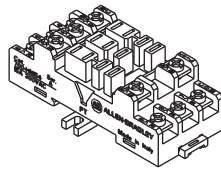
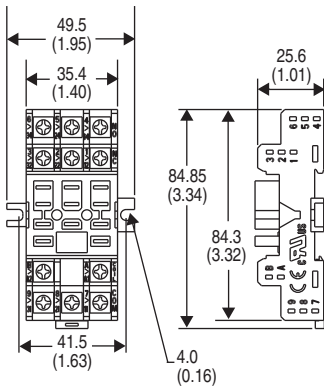

Cat. No. 700-HN154
Wire Size: 2 x 2.5 mm²
Single Wire – Up to #12 AWG
Double Wire – 2 x 2.5 mm² (#2–14 AWG... #2–20 AWG)
(Either Solid or Stranded)
Strip Length: 9 mm (3/8 in.) – Torque: 0.8 N•m (7 lb•in)

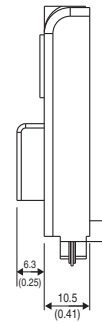
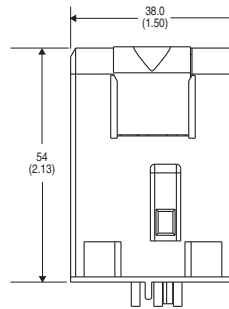

Cat. No. 700-HT3
Wire Size: 2 x 1.5 mm² (#2–16 AWG... #1–20 AWG)
(Either Solid or Stranded)
Strip Length: 9 mm (3/8 in.) – Torque: 0.8 N•m (7 lb•in)



Bulletin 700-HD — Flange Mount Square Base Relay

- Flange-mounted/panel-mounted
- 15 A contact rating
- DPDT, 3PDT
- Blade-style quick connect terminals (0.187 x 0.020)
- Solder terminals (no socket required)

Table of Contents

Product Selection this page
 Accessories..... this page
 Specifications..... 9-27
 Approximate Dimensions..... 9-28

Product Selection

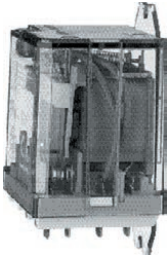
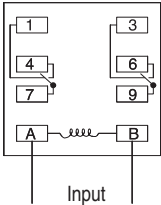
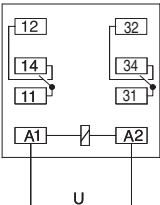
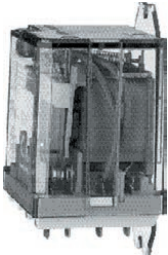
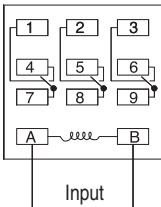
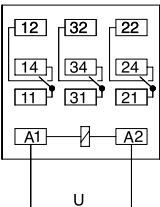
Description	Contact Rating	Wiring Diagrams		Coil Voltage	Cat. No.
		U.S./Canada	International		
 DPDT 2-Pole 2 Form C AgCdO Contacts	15 A			6V AC	700-HD32A06
				12V AC	700-HD32A12
				24V AC	700-HD32A24
				120V AC	700-HD32A1
				208V AC	700-HD32A20
				240V AC	700-HD32A2
				6V DC	700-HD32Z06
				12V DC	700-HD32Z12
				24V DC	700-HD32Z24
				48V DC	700-HD32Z48
		110V DC	700-HD32Z1		
 3PDT 3-Pole 3 Form C AgCdO Contacts	15 A			6V AC	700-HD33A06
				12V AC	700-HD33A12
				24V AC	700-HD33A24
				120V AC	700-HD33A1
				208V AC	700-HD33A20
				240V AC	700-HD33A2
				6V DC	700-HD33Z06
				12V DC	700-HD33Z12
				24V DC	700-HD33Z24
				48V DC	700-HD33Z48
		110V DC	700-HD33Z1		

Accessories

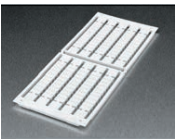
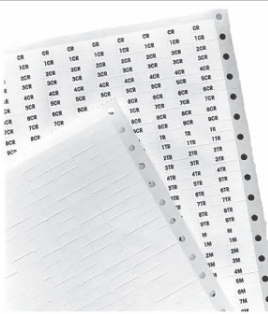
Description	Pkg. Quantity	Cat. No.
 Relay Identification Snap-in Markers* Snap-in markers fit on top of product covers. The following are blank cards. Squares slip into molded slot on top of product covers.	100	* 1492-MS5X12 * 1492-MS6X9 * 1492-MS6X12 * 1492-MS8X9 * 1492-MS8X12 * 1492-MP-Blank
 Pre-Printed Identification Tags — contains 10 sheets of pre-printed and blank tags. Each sheet contains 13 sets of the markings CR...9CR, TR...9TR, M...9M, F, R, 1S, and 117 blank tags. Tags are peel-off with sticky backing for easy placement on relays.	10	700-N40
Blank Identification Tags — contains 10 sheets of blank identification tags for customer specialized printing. Each sheet contains 546 blank tags. Tags are peel-off with sticky backing for easy placement on relays.	10	700-N41

* Performance Data – See this catalog, Important- 3

* For pre-printed marker cards, turn to the following 1492 sections of publication A115: 1492-MS5X12_, 1492-MS6X9_, 1492-MS8X9_, 1492-MS8X12_, 1492-MP_.

Specifications

Cat. No. 700-HD...						
Electrical Ratings						
Pilot Duty Rating*	NEMA B300					
Rated Thermal Current (I_{th})	15 A‡ – 120V 15 A‡ – 240V					
Rated Insulation Voltage (U _i)	250V IEC-300V UL/CSA					
Contacts	Inductive	Make ▶][◀		Break ◀][▶		Hp
		2-Pole	3-Pole	2-Pole	3-Pole	
	120V AC	60 A	30 A	6 A	3 A	3/4
	240V AC	30 A	15 A	3 A	1.5 A	2
	General Purpose	15 A, 240V AC				
Resistive	15 A, 30V DC					
Min. Low Energy Permissible Load	1000 mW (10V, 10 mA)					
Permissible Coil Voltage Variation	80...110% of Nominal Voltage at 50 Hz 80...110% of Nominal Voltage at 60 Hz 80...110% of Nominal Voltage at DC					
Coil Consumption ±10%	AC Coils	50 Hz		60 Hz		
	Inrush	3.3 VA		2.85 VA		
	Sealed	2.2 VA		1.9 VA		
	DC Coils	1.3 W				
Maximum Contact Resistance	50 mΩ					
Must Dropout Voltage	20% of Nominal V AC 10% of Nominal V DC					
Design Specification/Test Requirements						
Electrical						
Dielectric Withstand Voltage						
Pole-to-Pole	1500V					
Contact to Coil	6000V					
Contact to Frame	4000V					
Mechanical						
Degree of Protection (Open Type) IEC 529	IP 40					
Mechanical Life Cycles (AC/DC)	> 10 x 10 ⁶ / 30 x 10 ⁶					
Switching Frequency Operations	3600/HR					
Coil Voltages	See Overview/Product Selection					
Operating Time	Pickup	20 ms				
	Dropout	4 ms				
Maximum Operating Rate	4 Ops/s					
Minimum Low Energy Permissible Load	1000 mN (10V, 10mA)					
Environmental						
Temperature	Operating	-40...+70 °C				
	Storage	-40...+100 °C				
Altitude	2000 m (6560 ft)					
Construction						
Insulating Material	Molded High Dielectric Material					
Enclosure	Transparent Dust Cover					
Contact Material	Silver Cad. Ox.					
Terminal Markings	In accordance with EN50 0005					
Certifications	cURs Recognized (File No. E3125, Guide NLDX2/NLDX8), CSA Certified (File No. 229473), GE Marked, UR Certified					
Standards	UL 508, CSA C22.2 No. 14, EN 61810-1, EN 60255-23					

* Performance Data – See this catalog, Important- 3
 * NEMA Rating Chart is on page 19 of publication 700-SG003*
 ‡ 3-pole relays have a 20 A maximum total current rating for all three poles.

Note: Bulletin 700-HD wiring terminals are the quick connect/solder type 4.7 x 0.5 mm (0.187 x 0.020 in.) termination.

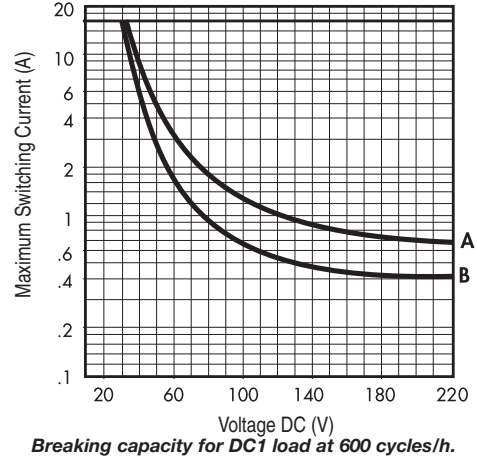
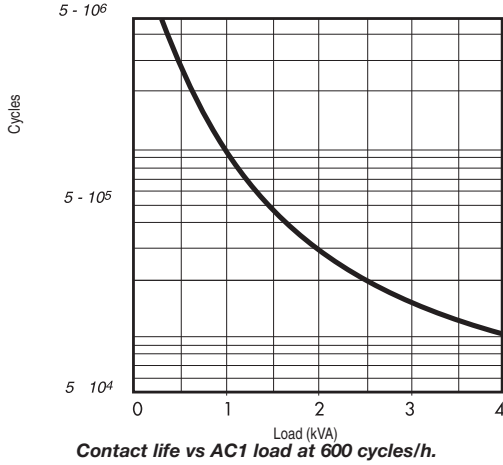

Load applied to 1 contact.
 A = for N.O. types
 B = other types

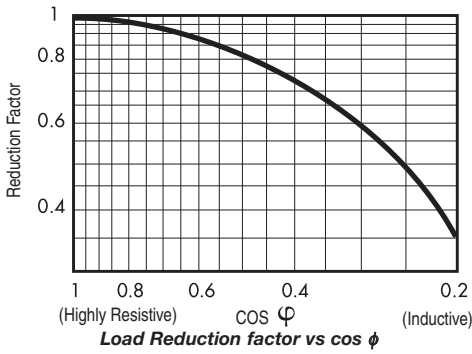

Approximate Dimensions

Approximate Dimensions are shown in millimeters (inches). Approximate Dimensions are not intended to be used for manufacturing purposes.

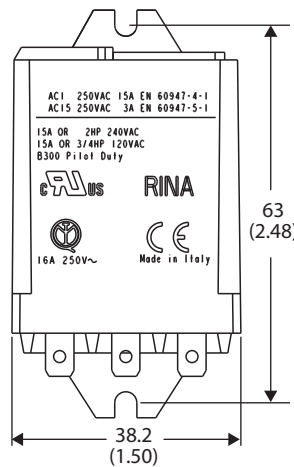
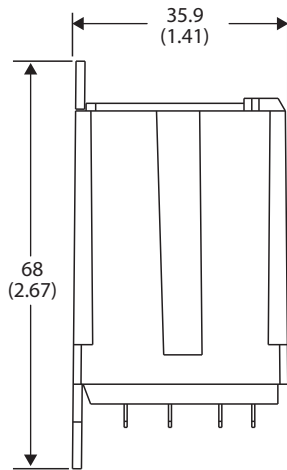

Bulletin 700-HD Relay

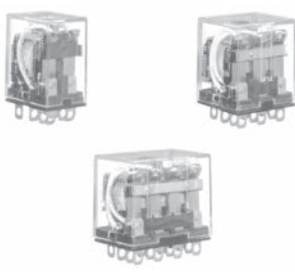
	<p>Bulletin 700-HF — Square Base Relay</p> <ul style="list-style-type: none"> • 10 A contact rating • DPDT, 3PDT, 4PDT • Plug-in quick connect solder terminals • Options: LED, push-to-test operator 	<p>Table of Contents</p> <p>Product Selection this page</p> <p>Accessories..... 9-30</p> <p>Specifications 9-31</p> <p>Approximate Dimensions..... 9-32</p> <p>Standards Compliance and Certifications</p> <p>See Specification table in this section, page 9-31 .</p>
---	--	--

Product Selection
Square Base with Quick Connect/Solder Style Terminations

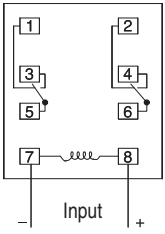
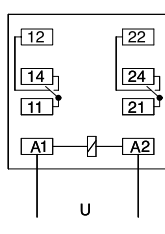
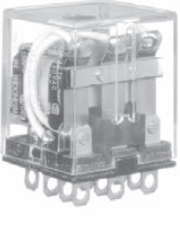
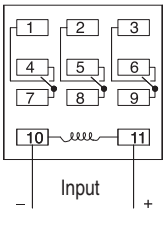
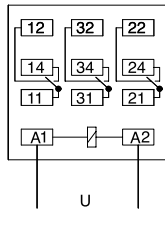
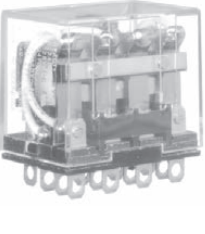
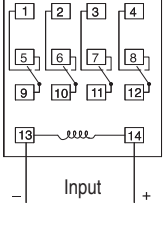
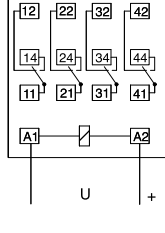
	Description	Contact Rating	Wiring Diagrams		Coil Voltage	Cat. No. *❖
			U.S./Canada	International		
	DPDT 2-pole 2 Form C AgCdO Contacts Socket	10 A			6V AC	700-HF32A06
			12V AC	700-HF32A12		
			24V AC	700-HF32A24		
			120V AC	700-HF32A1		
			240V AC	700-HF32A2		
			6V DC	700-HF32Z06		
			12V DC	700-HF32Z12		
			24V DC	700-HF32Z24		
			48V DC	700-HF32Z48		
			110V DC	700-HF32Z1		
	3PDT 3-pole 3 Form C AgCdO Contacts Socket	10 A			6V AC	700-HF33A06
			12V AC	700-HF33A12		
			24V AC	700-HF33A24		
			120V AC	700-HF33A1		
			240V AC	700-HF33A2		
			6V DC	700-HF33Z06		
			12V DC	700-HF33Z12		
			24V DC	700-HF33Z24		
			48V DC	700-HF33Z48		
			110V DC	700-HF33Z1		
	4PDT 4-pole 4 Form C AgCdO Contact Socket	10 A			6V AC	700-HF34A06
			12V AC	700-HF34A12		
			24V AC	700-HF34A24		
			120V AC	700-HF34A1		
			240V AC	700-HF34A2		
			6V DC	700-HF34Z06		
			12V DC	700-HF34Z12		
			24V DC	700-HF34Z24		
			48V DC	700-HF34Z48		
			110V DC	700-HF34Z1		

* Pilot Light Option: Add suffix (-4) to the selected Bulletin 700-HF Relay Cat. No. except for the 240V AC units, add (-4L).

❖ Manual Operator and LED Option: Add suffix (-1-4) to the selected Bulletin 700-HF Relay Cat. No., except for the 240V AC units, add (-1-4L).



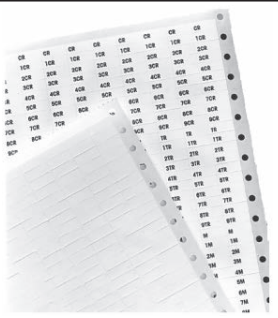

Bulletin 700-HF
General Purpose Relays
 Accessories

Accessories

	Description	Pkg. Quantity	Cat. No.
	Pre-Printed Identification Tags — contains 10 sheets of pre-printed and blank tags. Each sheet contains 13 sets of the markings CR...9CR, TR...9TR, M...9M, F, R, 1S, and 117 blank tags. Tags are peel-off with sticky backing for easy placement on relays.	10	700-N40
	Blank Identification Tags — contains 10 sheets of blank identification tags for customer specialized printing. Each sheet contains 546 blank tags. Tags are peel-off with sticky backing for easy placement on relays.	10	700-N41

* Performance Data – See this catalog, Important- 3.

⊛ For pre-printed marker cards, turn to the following 1492 sections of this publication: 1492-MS5X12_, 1492-MS6X9_, 1492-MS8X9_, 1492-MS8X12_, 1492-MP_.

	Description	Pkg. Qty.	Cat. No.
 <i>Cat. No 700-HN116</i>	Screw Terminal Socket — Panel or DIN Rail Mounting 8-blade miniature socket for use with DPDT HF relays.	10	700-HN116
 <i>Cat. No. 700-HN138</i>	Screw Terminal Socket — Panel or DIN Rail Mounting 11-blade socket for use with 3PDT Bulletin 700-HF relays.	1	700-HN138
 <i>Cat. No. 700-HN139</i>	Screw Terminal Socket — Panel or DIN Rail Mounting, Guarded Terminal Construction 14-blade socket for use with 4PDT Bulletin 700-HF relays.	1	700-HN139
 <i>Cat. No 199-DR1</i>	DIN (#3) symmetrical hat rail 35 x 7.5 x 1 m	10	199-DR1
 <i>Sample Retainer Clips</i>	Retainer Clip for Cat. Nos. 700-HN103, -HN104 and -HN128 Sockets with 700-HC Relays and Cat. Nos. 700-HN116 Sockets with Bulletin 700-HF DPDT Relays ‡ Secures relay in socket. Order must be for 10 clips or multiples of 10.	10	700-HN114
	Retainer Clip for Cat. Nos. 700-HN138 and -HN139 Sockets with Bulletin 700-HF 3PDT and 4PDT Relays ‡ Secures relay in socket. Order must be for 10 clips or multiples of 10.	10	700-HN140

‡ Bulletin 700-HF Square Base Relay, Socket, and Retainer Clip Reference

Relay Type	Cat. No. Socket	Cat. No. Retainer Clip
700-HF32	700-HN116	700-HN114
700-HF33	700-HN138	700-HN140
700-HF34	700-HN139	700-HN140

Specifications*

Cat. No. 700-HF...				
Electrical Ratings				
Pilot Duty Rating		C300		
Rated Thermal Current (I_{th})		10 A		
Rated Insulation Voltage (U)		250V IEC, 300 UL/CSA		
Contacts	Inductive	Make	Break	Hp
		►][◄	◄][►	
	120V AC	29 A	2.9 A	1/2
	240V AC	14 A	1.4 A	1/3
	General Purpose	10 A, 240V AC		
Resistive		10 A, 30V DC		
Min. Low Energy Permissible Load		5V, 100 mA		
Permissible Coil Voltage Variation		85...110% of Nominal Voltage at 50 Hz 85...110% of Nominal Voltage at 60 Hz 80...110% of Nominal Voltage at DC		
Coil Consumption ±10%	AC Coils		50 Hz	60 Hz
		Inrush	2.4 VA	2.1 VA
		Sealed	1.6 VA	1.4 VA
	DC Coils	0.9 W (Bul. No. 700-HF32) 1.4 W (Bul. No. 700-HF33) 1.5 W (Bul. No. 700-HF34)		
Max. Allowable Leakage		25% of VA		
		10% of W		
Design Specification/Test Requirements				
Dielectric Withstand Voltage	Pole-to-Pole		1500V AC	
	Contact to Pole		1500V AC	
	Contact to Frame		1500V AC	
Mechanical				
Degree of Protection		Open Type (Sockets)		
Mechanical Life Operations		30 x 10 ⁶		
Switching Frequency Operations		3600/hr		
Coil Voltages		See Product Selection		
Operating Time at Nominal Voltage at 20 °C	Pickup	15 ms		
	Dropout	15 ms		
Maximum Operating Rate		4 Ops/s		
Shock (Mechanical Durability)		100 G		
Shock (Malfunction Durability)		20 G		
Environmental				
Temperature	Operating	-30...+55 °C (-22...+131 °F)		
	Storage	-55...+85 °C (-67...+185 °F)		
Altitude		2000 m (6560 ft)		
Construction				
Insulating Material		Molded High-Dielectric Material		
Enclosure		Transparent Dust Cover		
Contact Material		Silver Cad. Ox.		
Terminal Markings on Socket		In accordance with EN50 0005		
Sockets		8-Blade Socket (DPDT) Cat. No. 700-HN116 11-Blade Socket (3PDT) Cat. No. 700-HN138 14-Blade Socket (4PDT) Cat. No. 700-HN139		
Certifications		CSA Certified (File No. 75088), UL Recognized (File No. E3125, Guide NLDX 2), CE Marked		
Standards		UL 508, CSA 22.2 No. 14, EN/IEC 60255-1		

* Performance Data – See this catalog, Important- 3.



Bulletin 700-HF
General Purpose Relays
 Approximate Dimensions

Approximate Dimensions

Approximate Dimensions are shown in millimeters (inches). Approximate Dimensions are not intended to be used for manufacturing purposes.

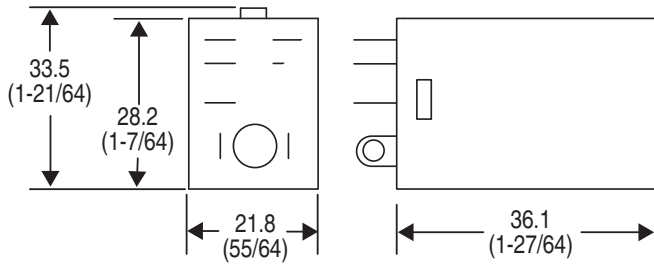

Bulletin 700-HF Relay (DPDT)

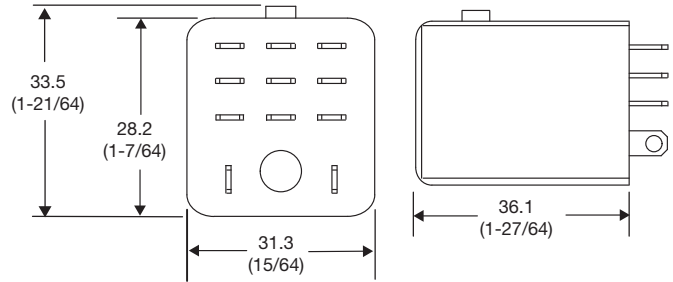

Bulletin 700-HF (3PDT)

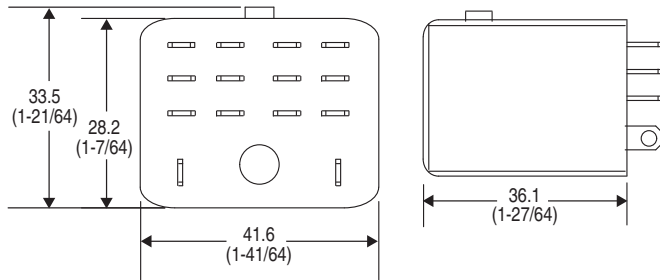

Bulletin 700-HF (4PDT)

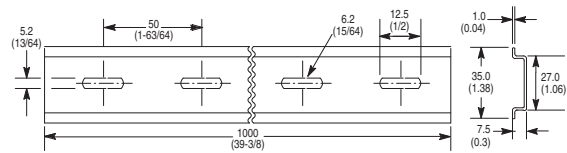

Cat. No. 199-DR1 DIN Mounting Rail Series B
Cat. No. 199-DR4 DIN Mounting Rail Series B Has No Mounting Holes

Cat. No.	A	B	C	D	Approx. Shipping Wt.
199-DR1	35 (1-3/8)	27 (1-1/16)	7.5 (19/64)	1.02 (1/64)	1.85 kg (4.07 lb) (10/pkg)
199-DR4	35 (1-3/8)	27 (1-1/16)	15 (19/32)	2.3 (3/32)	3.68 kg (8 lb) (5/pkg)

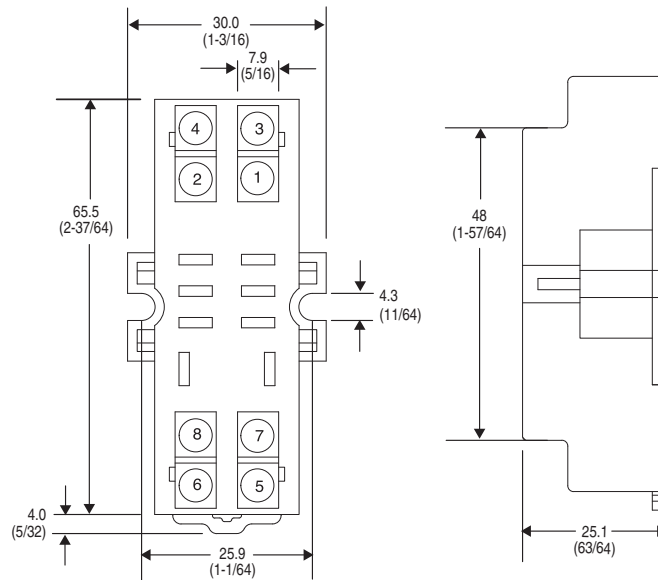

Cat. No. 700-HN116
Wire Size: 2 x 2.5 mm²
Single Wire - Up to #12 AWG
Double Wire - 2 x 2.5 mm² (#2-14 AWG... #2-20 AWG)
(Either Solid or Stranded)
Strip Length: 9 mm (3/8 in.) - Torque: 0.8 N•m (7 lb-in)

Approximate Dimensions are shown in millimeters (inches). Approximate Dimensions are not intended to be used for manufacturing purposes.

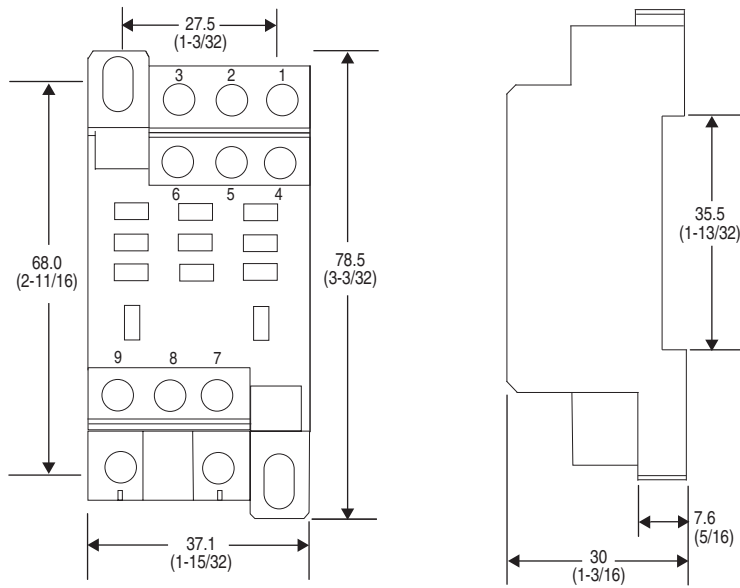

Cat. No. 700-HN138
 Wire Size: 2 x 2.5 mm²
 Single Wire – Up to #12 AWG
 Double Wire – 2 x 2.5 mm² (#2–14 AWG... #2–20 AWG)
 (Either Solid or Stranded)
 Strip Length: 9 mm (3/8 in.) – Torque: 0.8 N•m (7 lb-in)

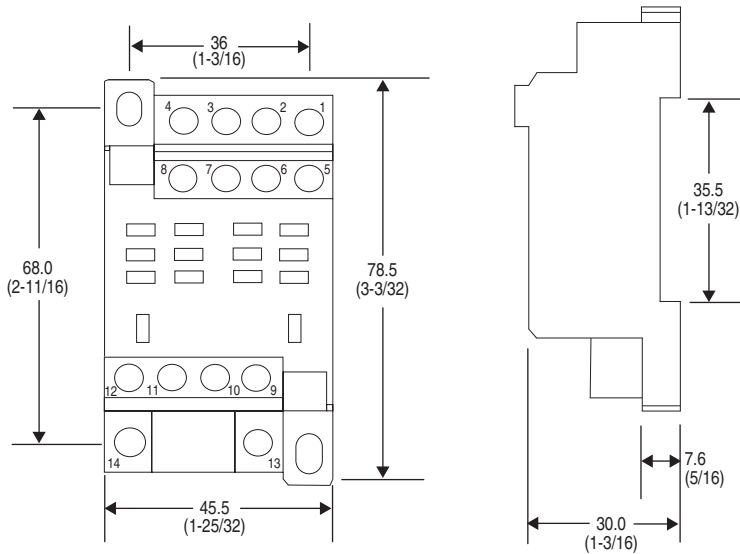

Cat. No. 700-HN139
 Wire Size: 2 x 2.5 mm²
 Single Wire – Up to #12 AWG
 Double Wire – 2 x 2.5 mm² (#2–14 AWG... #2–20 AWG)
 (Either Solid or Stranded)
 Strip Length: 9 mm (3/8 in.) – Torque: 0.8 N•m (7 lb-in)

Bulletin 700-HC
Interposing/Isolation Relays
 Product Overview/Product Selection

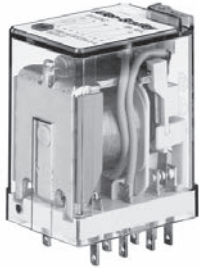

Bulletin 700-HC — Miniature Ice Cube Relay

- 7 or 10 A contact ratings
- 2PDT or 4PDT
- Standard ON/OFF flag indicator
- Blade-style terminals
- Choice of standard silver nickel contacts, or silver nickel with gold-plated contacts for low-energy applications
- Options: LED, push-to-test with manual override option
- Tungsten UL Approvals
 4-Pole: 5A @ 24V DC
 2-Pole: 10A @ 24V DC

Table of Contents







- Product Selection this page
- Accessories..... 9-35
- Specifications..... 9-37
- Approximate Dimensions..... 9-38
- Standards Compliance and Certifications**
- See Specification table in this section, page 9-37.

Product Selection
Bulletin 700-HC Miniature Square Base with Blade Terminals

	Description	Contact Rating	Wiring Diagrams		Coil Voltage	Cat. No. * ❄
			U.S./Canada	International		
	2PDT 2-Pole 2 Form C Contacts: 10 A = AgNi Contacts	10 A C300 R300 Low energy rating; (10V, 10 mA) 100 mW			12V DC	700-HC22Z12
			700-HN128	700-HN103 700-HN104	24V DC	700-HC22Z24
					24V AC	700-HC22A24
					120V AC	700-HC22A1
					240V AC	700-HC22A2
	4PDT 4-Pole 4 Form C Contacts: 7A = AgNiAu Gold Plated Contacts	7 A Low energy rating; (5V, 10 mA or 25V, 2 mA) 50 mW			6V AC	700-HC14A06
12V AC					700-HC14A12	
24V AC					700-HC14A24	
120V AC					700-HC14A1	
240V AC					700-HC14A2	
6V DC					700-HC14Z06	
12V DC					700-HC14Z12	
24V DC					700-HC14Z24	
48V DC					700-HC14Z48	
110V DC					700-HC14Z1	
	4PDT 4-Pole 4 Form C Contacts: 7A = AgNi Silver Contacts	7 A C300 R300 Low energy rating; (10V, 10 mA) 100 mW	700-HN128	700-HN103 700-HN104	6V AC	700-HC24A06
12V AC					700-HC24A12	
24V AC					700-HC24A24	
120V AC					700-HC24A1	
240V AC					700-HC24A2	
6V DC					700-HC24Z06	
12V DC					700-HC24Z12	
24V DC					700-HC24Z24	
48V DC					700-HC24Z48	
110V DC					700-HC24Z1	

* LED Option: Add suffix **(-4)** to the selected Bulletin 700-HC Relay Cat. No. except for the 240V AC units, add **(-4L)**.
 ❄ Push-to-Test and LED Option: Add suffix **(-3-4)** to the selected Bulletin 700-HC Relay Cat. No., except for the 240V AC units, add **(-3-4L)**.

Accessories

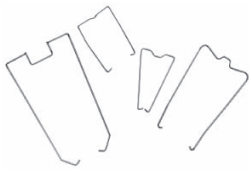
	Description	Pkg. Qty.	Cat. No.
	Diode with LED Surge Suppressor Voltage Range: 6...24V DC used with 700-HN104 socket	10	700-ADL1
	Diode with LED Surge Suppressor Voltage Range: 28...60V DC used with 700-HN104 socket	10	700-ADL2
	Diode with LED Surge Suppressor Voltage Range: 110...220V DC used with 700-HN104 socket	10	700-ADL3
	Varistor with LED Surge Suppressor Voltage Range: 6...24V AC used with 700-HN104 socket	10	700-AV1R
	Varistor with LED Surge Suppressor Voltage Range: 110...240V AC used with 700-HN104 socket	10	700-AV3R
	RC Surge Suppressor Voltage Range: 6...24V AC/DC used with 700-HN104 socket	10	700-AR1
	RC Surge Suppressor Voltage Range: 110...240V AC/DC used with 700-HN104 socket	10	700-AR2
	Timing Module On-Delay or One-Shot selectable voltage range: 12...24V AC/DC used with sockets that accept plug-in accessory modules.	1	700-AT3
	Timing Module On-Delay or One-Shot selectable voltage range: 110...125V AC used with sockets that accept plug-in accessory modules.		700-AT3A1
	Timing Module On-Delay or One-Shot selectable voltage range: 230...240V AC used with sockets that accept plug-in accessory modules.		700-AT3A2
 Cat. No. 700-HN103	Screw Terminal Socket — Panel or DIN Rail Mounting; Guarded Terminal Construction. $I_{th} = 10$ A per pole. 14-blade miniature socket for use with Bulletin 700-SC Relays.	10	700-HN103
 Cat. No. 700-HN104	Screw Terminal Socket — Panel or DIN Rail Mounting; Guarded Terminal Construction $I_{th} = 10$ A per pole. 14-blade miniature socket for use with Bulletin 700-SC relays. This socket has coil and contact separation as well as the ability to plug in optional plug in modules (700-A__ accessories: LED, Surge Suppression, Timing Modules)	10	700-HN104
 Cat. No. 700-HN128	Screw Terminal Base Socket — Panel or DIN Rail Mounting; Open-Style Construction $I_{th} = 10$ A per pole. 14-blade miniature socket for use with Bulletin 700-SC Relays.	10	700-HN128
 Cat. No. 199-DR1	DIN (#3) symmetrical hat rail 35 x 7.5 x 1 m	10	199-DR1
 Sample Retainer Clips	Retainer Clip for Cat. Nos. 700-HN103, -HN104 and -HN128 Sockets with 700-HC Relays. Secures relay in socket. *	10	700-HN114
	Plastic Retainer and Ejection Lever For use with the 700-HN104 Sockets for 700-HC relays. Built-in ability to accept 1492 Snap-in Markers	10	700-HN124

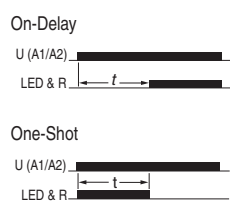

* See Bulletin 700-HC Miniature Square Base Relay, Socket, and Retainer Clip Reference Chart

Bulletin 700-HC
Interposing/Isolation Relays
 Accessories

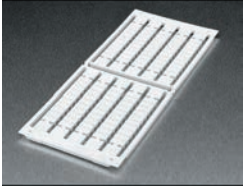
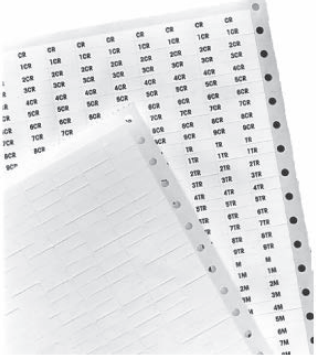
	Description	Pkg. Qty.	Cat. No.
 <p>Snap-in markers</p>	<p>Relay Identification Snap-in Markers Snap-in markers fit on top of product covers. Squares slip into molded slot on top of product cover.</p>	5	1492-MS5X12
		5	1492-MS6X9
		5	1492-MS6X12
		5	1492-MS8X9
		5	1492-MS8X12
	<p>Pre-Printed Identification Tags — contains 10 sheets of pre-printed and blank tags. Each sheet contains 13 sets of the markings CR...9CR, TR...9TR, M...9M, F, R, 1S, and 117 blank tags. Tags are peel-off with sticky backing for easy placement on relays.</p>	10	700-N40
	<p>Markers — Used for terminal identification</p>	50	700-N41

Relay Type	Socket Cat. No.	Retainer Clip Cat. No.
700-HC	700-HN103	700-HN114
	700-HN128	700-HN114
	700-HN104	700-HN114 or 700-HN124

Specifications

Cat. No. 700-HC...							
Electrical Ratings							
Pilot Duty Rating *		NEMA C300, R300					
Rated Thermal Current (I_{th})		7 A and 10 A					
Rated Insulation Voltage (U _i)		250V IEC – 300V UL/CSA					
Contacts	Inductive	700-HC_4		Hp	700-HC22		Hp
		►][◀	◀][►		►][◀	◀][►	
	120V AC	15 A	1.5 A	1/8	15 A	1.5 A	1/3
	240V AC	7.5 A	0.75 A	1/3	7.5 A	0.75 A	3/4
	General Purpose	7 A, 277V AC			10 A, 277V AC		
Resistive	7 A, 30V DC			10 A, 24V DC			
Min. Low Energy Permissible Load		100 mW (10V, 10 mA) - Silver Contacts 50 mW (5V, 10 mA or 25V, 2 mA) - Gold Contacts					
Permissible Coil Voltage Variation		Pickup: 80...110% of Nominal Voltage at 50 Hz 80...110% of Nominal Voltage at 60 Hz 80...110% of Nominal Voltage at DC		Must Dropout Voltage: 20% of Nominal Voltage at AC 10% of Nominal Voltage at DC			
		50 Hz		60 Hz			
Coil Consumption ±10%	AC Coils	Inrush	2.2 VA		1.6 VA		
		Sealed	1.3 VA		1.1 VA		
	DC Coils	1.0 W					
Max. Allowable Leakage		20% of VA (AC) 10% of W (DC)					
Design Specification/Test Requirements							
Electrical							
Dielectric Withstand Voltage	Pole-to-Pole	1000V					
	Contact to Coil	3600V					
	Contact to Frame	3600V					
Electrical Life (Cycles)		100 000 minimum					
Mechanical							
Degree of Protection (Open Type) IEC 529		IP 20 (Guarded Terminal Sockets)					
Mechanical Life Cycles		20 x 10 ⁶ (AC) 50 x 10 ⁶ (DC)					
Switching Frequency Operations		1800/HR					
Coil Voltages		See Product Selection					
Operating Time (ms)	Max. Pickup	10					
	Max. Dropout	3					
Maximum Operating Rate		8 cycles/s					
Environmental							
Temperature	Operating	-30...+55 °C (-22...+131 °F)					
		Storage	-55...+85 °C (-67...+185 °F)				
Altitude			2000 m (6560 ft)				
Insulating Material		Molded High Dielectric Material					
Enclosure		Transparent Dust Cover					
Contact Material		AgNi (700-HC2) AgNi + 5 µm AlI (700-HC1)					
Terminal Markings on Socket		In accordance with EN50 0005					
Sockets		700-HN103, -HN128, -HN104					
Certifications		cURus Recognized (File No. E14843, Guide NRNT2/NRNT8), cULus Listed when used with Bulletin 700-HN103, -HN104, and -HN128 sockets (File No. E14843, Guide NRNT/NRNT7), CE Marked, LR Certified					
Standards		UL 508, CSA 22.2 No. 14, EN/IEC 60947-4-1, EN/IEC 60947-5-1					

* Performance Data – See this catalog, Important 3.
 * NEMA Rating Chart is in publication 700-SG003_-EN-P.



Bulletin 700-HC
Interposing/Isolation Relays
 Approximate Dimensions

Approximate Dimensions

Approximate Dimensions are shown in millimeters (inches). Approximate Dimensions are not intended to be used for manufacturing purposes.

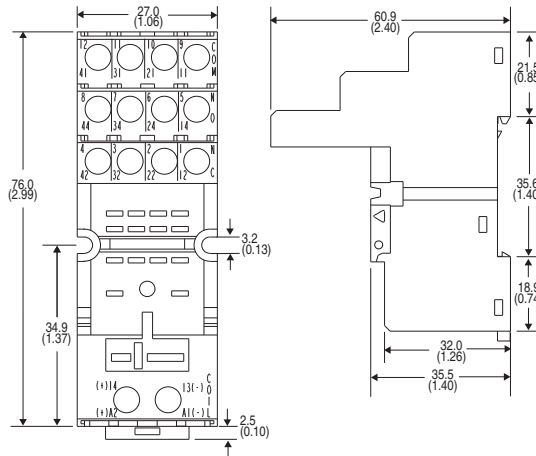
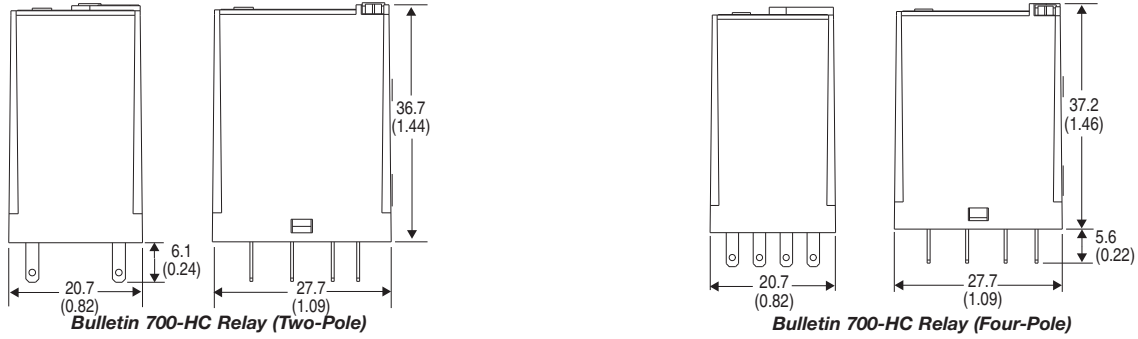

Cat. No. 700-HN104

Single Wire: 0.2 mm²...2.5 mm² (#24 AWG...14 AWG)
 Double Wire: 2 x 0.2 mm²...2 x 2.5 mm² (2 x 24 AWG...2 x 14 AWG)
 Wire Type: solid or stranded, copper only
 Strip Length: 7 mm (9/32 in.), Torque: 0.5 N•m (4.4 lb•in)

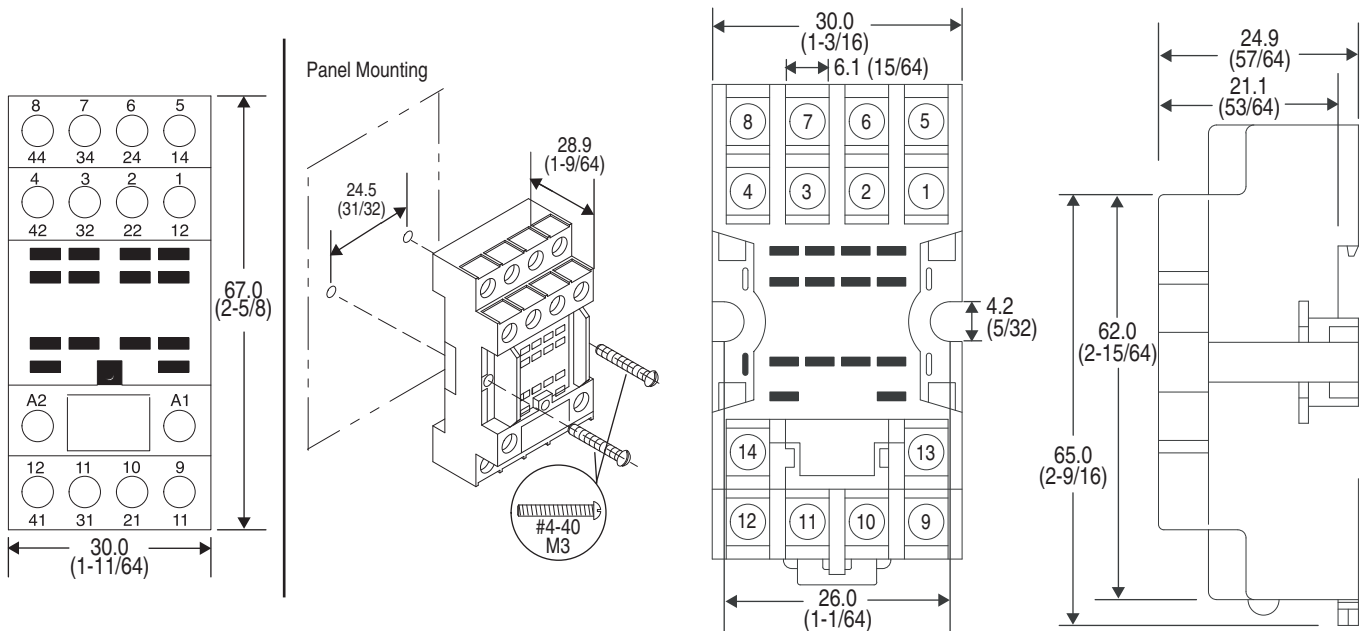

Cat. No. 700-HN103

Single Wire: 0.2 mm²...2.5 mm² (#24 AWG...14 AWG)
 Double Wire: 2 x 0.2 mm²...2 x 1.5 mm² (2 x 24 AWG...2 x 16 AWG)
 Wire Type: Solid or Stranded, Copper only
 Strip Length: 8 mm (5/16 in.), Torque: 0.5 N•m (4.4 lb•in)

Cat. No. 700-HN128

Wire Size: 2 x 1.5mm² (#2-16 AWG...#1-20 AWG)
 (Either Solid or Stranded)
 Strip Length: 9 mm (3/8 in.) - Torque: 0.8 N•m (7 lb•in)



Bulletin 700-HK — “Slim Line” Relay

- 8 A/16 A contact ratings
- DPDT/SPDT
- Plug-in blade-style terminals
- Retainer clip with sockets
- Options: LED, push-to-test and manual override, socket-mounted surge suppressor module, or timer module
- Standard ON/OFF flag indicator
- Relay faceplate accepts optional Bulletin 1492 snap-in markers
- Choice of standard silver/nickel contacts or silver/nickel with gold plated contacts
- Maximum duty version available

Table of Contents



Product Selection this page
 Accessories..... 9-40
 Specifications..... 9-44
 Approximate Dimensions..... 9-43

Standards Compliance and Certifications

See Specification table in this section, page 9-42.

Product Selection

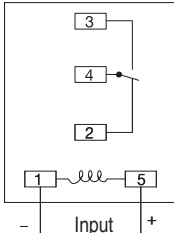
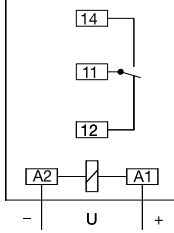
Slim Line Relay with Plug-in Quick Connect Terminations

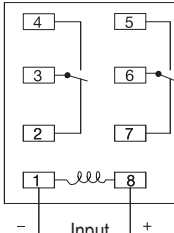
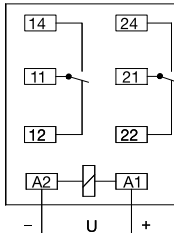



	Description	Contact Rating	Wiring Diagrams		Coil Voltage	Cat. No.*‡
			U.S./Canada	International		
 Bulletin 700-HK SPDT	SPDT 1-Pole 1 Form C AgNi Contacts Socket	16 A			6V AC	700-HK36A06
			12V AC	700-HK36A12		
			24V AC	700-HK36A24		
			120V AC	§ 700-HK36A1		
			240V AC	§ 700-HK36A2		
			6V DC	700-HK36Z06		
			12V DC	700-HK36Z12		
			24V DC	§ 700-HK36Z24		
48V DC	700-HK36Z48					
110V DC	700-HK36Z1					
 Bulletin 700-HK DPDT	DPDT 2-Pole 2 Form C AgNi Contacts Socket	8 A			6V AC	700-HK32A06
			12V AC	700-HK32A12		
			24V AC	700-HK32A24		
			120V AC	700-HK32A1		
			240V AC	700-HK32A2		
			6V DC	700-HK32Z06		
			12V DC	700-HK32Z12		
			24V DC	700-HK32Z24		
48V DC	700-HK32Z48					
110V DC	700-HK32Z1					

* LED Option: Add suffix (-4) to the selected Bulletin 700-HK relay Cat. No. except for the 240V AC units, add (-4L).
 ‡ For AgNi Contact with Gold Plating: Replace “3” with “X” in Cat. No. For example, if Cat. No. 700-HK36A1 is required with Gold Plating, the new catalog number is 700-HKX6A1.
 † Push-to-Test + Manual Override + LED Option: Add suffix (-3-4) to the selected 700-HK Relay catalog number, except for the 240V AC Units, add (-3-4L).
 § For high inductive, Tungsten, or Capacitive load applications, replace the “3” with a “M” in the catalog number. Only available in a SPDT configuration and with 24V DC, 120V AC or 240V AC coil voltages.

Bulletin 700-HK
Interposing/Isolation Relays
 Accessories

Accessories

	Description	Pkg. Qty.	Cat. No.
 Cat. No. 700-HN121	Screw Terminal Socket — Panel or DIN Rail Mounting 5-blade miniature socket with 10 A rating for use with 1-pole, Bulletin 700-HK relays. Accepts forked lug conductors. Socket includes a retainer clip.	10	700-HN121
 Cat. No. 700-HN221	Screw Terminal Socket — Panel or DIN Rail Mounting 5-blade miniature socket with 16 A rating for use with 1-pole, Bulletin 700-HK relays. Retainer clips are packaged separately with socket. Guarded terminal construction and compatible with optional plug-in module accessories.	10	700-HN221
	Spring Clamp Terminal Socket — Panel or DIN Rail Mounting 5-blade miniature socket for use with 1-pole, Bulletin 700-HX relays.	10	700-HN223
 Cat. No. 700-HN122	Screw Terminal Socket — Panel or DIN Rail Mounting 8-blade miniature socket with 5 A rating for use with 2-pole, Bulletin 700-HK relays. Accepts forked lug conductors. This socket includes a retainer clip.	10	700-HN122
 Cat. No. 700-HN222	Screw Terminal Socket — Panel or DIN Rail Mounting 8-blade miniature socket with 8 A rating for use with 2-pole, Bulletin 700-HK relays. Retainer clips are packaged separately with socket. Guarded terminal construction and compatible with optional plug-in module accessories.	10	700-HN222
	Spring Clamp Terminal Socket — Panel or DIN Rail Mounting 8-blade miniature socket for use with 2-pole Bulletin 700-HX relays.	10	700-HN224
 Cat. No. 700-HN226	Flange Mount Adapter Used for panel-mounting bulletin 700-HK relays. Order must be for 10 adapters or multiples of 10.	10	700-HN226
 Cat. No. 700-HN227	35 mm Rail Mount Adapter Mounts bulletin 700-HK relays to a 35 mm rail. Order must be for 10 adapters or multiples of 10.	10	700-HN227
 Cat. No. 700-HN229	Socket Retainer Clip and Ejection Lever For use with 700-HN22, -HN222, -HN223, and -HN224 sockets. Orders must be for 10 clips or multiples of 10.	10	700-HN229

	Description	Pkg. Qty.	Cat. No.
	Diode Surge Suppressor Voltage Range: 6...220V DC used with 700-HN221, 700-HN222 sockets	10	700-ADR
	Diode with LED Surge Suppressor Voltage Range: 6...24V DC used with 700-HN221, 700-HN222 sockets	10	700-ADL1R
	Diode with LED Surge Suppressor Voltage Range: 28...60V DC used with 700-HN221, 700-HN222 sockets	10	700-ADL2R
	Diode with LED Surge Suppressor Voltage Range: 110...220V DC used with 700-HN221, 700-HN222 sockets	10	700-ADL3R
	Varistor with LED Surge Suppressor Voltage Range: 6...24V AC used with 700-HN221, 700-HN222 sockets	10	700-AV1R
	Varistor with LED Surge Suppressor Voltage Range: 110...240V AC used with 700-HN221, 700-HN222 sockets	10	700-AV3R
	RC Surge Suppressor Voltage Range: 6...24V AC/DC used with 700-HN221, 700-HN222 sockets	10	700-AR1
	RC Surge Suppressor Voltage Range: 110...240V AC/DC used with 700-HN221, 700-HN222 sockets	10	700-AR2
	Timing Module On-Delay or One-Shot selectable voltage range: 12...24V AC/DC used with sockets that accept plug-in accessory modules.	1	700-AT3
	Timing Module On-Delay or One-Shot selectable voltage range: 110...125V AC used with sockets that accept plug-in accessory modules.		700-AT3A1
	Timing Module On-Delay or One-Shot selectable voltage range: 230...240V AC used with sockets that accept plug-in accessory modules.		700-AT3A2
 <i>Cat. No. 700-HN180</i>	8-Way Jumper can be cut to required length. Rated 10 A – 250V. Used with 700-HN221, 700-HN222 sockets.	1	700-HN180R
			700-HN180G
			700-HN180B
 <i>Cat. No. 199-DR1</i>	DIN (#3) symmetrical hat rail 35 x 7.5 x 1 m	10	199-DR1
	Relay Identification Snap-in Markers Snap-in markers fit on top of product covers. The following are blank cards.	100	1492-MS6X9
			1492-MS6X12
			1492-MS8X12

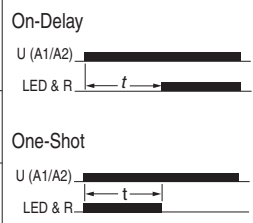

Note: Spring clamp sockets are also available. Cat. No. 700-HN223 for Cat. No. 700-HK36 and Cat. No. 700-HN224 for 700-HK32.

Bulletin 700-HK Slim Line Relay, Socket, and Retainer Clip Reference Chart

Relay Type	Socket Cat. No.	Retainer Clip Cat. No.
700-HK32	700-HN122, 700-HN222, 700-HN224	Provided
700-HK36	700-HN121, 700-HN221, 700-HN223	

Bulletin 700-HK
Interposing/Isolation Relays
Specifications

		Cat. No. 700-HK...			
Electrical Ratings					
Rated Thermal Current (I_{th})		1-Pole, 1 CO, SPDT — 16 A		2-Pole, 2 CO, DPDT — 8 A	
Rated Insulation Voltage (U _i)		250V IEC, 300V UL/CSA			
Contacts	Inductive V AC	120V AC	AC-15, 6.2 A B300 Pilot Duty, 3 A A300 (700-HKM ₁) 1/3 Hp (0.24 kW) 1-phase	120V AC	AC-15, 2.9 A B300 Pilot Duty, 3.0 A 1/4 Hp (0.18 kW), 1-phase
		240V AC	AC-15, 3.1 A B300 Pilot Duty, 1.5 A A300 (700-HKM ₁) 3/4 Hp (0.55 kW), 1-phase	240V AC	AC-15, 1.4 A B300 Pilot Duty, 1.5 A 1/2 Hp (0.37 kW), 1-phase
		230V AC	0.55 kW, 1-phase	230V AC	0.37 kW, 1-phase
	Inductive V DC	24V DC	DC-13, 5.0 A	24V DC	DC-13, 3.0 A
		125V DC	DC-13, 0.2 A R300 Pilot Duty, 0.22 A	125V DC	DC-13, 0.2 A R300 Pilot Duty, 0.22 A
		250V DC	DC-13, 0.1 A R300 Pilot Duty, 0.11 A	5 A, 250V AC	DC-13, 0.1 A R300 Pilot Duty, 0.11 A
	Resistive	230V AC	AC-1, 16 A	230V AC	AC-1, 8 A
		277V AC	16 A, General Use	277V AC	8 A, General Use
Make, Break & Continuous	30V DC	DC-1, 12 A 10 A, Resistive	30V DC	DC-1, 6 A 6 A, Resistive	
Min. Permissible Contact Ratings		300 mW (5V/60 mA or 60V/5 mA) for AgNi Contacts (700-HK3 ₁) 50 mW (5V/10 mA or 25V/2 mA) for AgNi + Gold Contacts (700-HKX ₁) 500 mW (100V/5 mA or 5V/100 mA) for AgSnO ₂ Contacts (700-HKM ₁)			
Permissible Coil Voltage Variation	Pickup: holding Voltage: Must Dropout Voltage:	80...110% of Nominal Voltage at 50/60 Hz, 73...110% of Nominal Voltage at DC 80% of Nominal V AC at 50/60 Hz, 40% of Nominal V DC 20% of Nominal V AC at 50/60 Hz, 10% Nominal V DC			
Power Consumption		1.2V A (V AC Coils), 0.5 W (V DC Coils)			
Coil Voltages		See Overview/Product Selection			
Design Specification/Test Requirements					
Dielectric Withstand Voltage	Between Open Contacts (VRMS)	1000V AC			
	Contact to Coil (VRMS)	1600V AC			
Mechanical					
Degree of Protection		IP 20 (guarded terminal sockets), RT II — Flux-proof (Relay)			
Mechanical Life Operations		10 x 10 ⁶			
Electrical Life Cycles		230V AC, 16 A Resistive: 100 000 min. 277V AC, 16 A Resistive: 30 000 min. 30V DC, 10 A Resistive: 30 000 min. B300, R300, Hp (kW): 6000 min. A300 (700-HKM ₁): 100,000 min.		230V AC, 8 A Resistive: 100 000 min. 277V AC, 8 A Resistive: 30 000 min. 30V DC, 6 A Resistive: 30 000 min. B300, R300, Hp (kW): 6000 min.	
Switching Frequency		Mechanical: 18,000 cycles/hr. Electrical: 900 cycles/hr.			
Operating Time at Nominal Voltage at 20 °C (ms)	Pickup	15 ms max.			
	Dropout	5 ms max.			
Vibration	Operational	10...2000 Hz, 0.76 mm (0.03 in.) 2.5 G			
	Non-Operational	10...2000 Hz, 0.76 mm (0.03 in.) 5.0 G			
Shock	Operational	15 G			
	Non-Operational	50 G			
Environmental					
Temperature	Operating	-40...+70 °C (-40...+158 °F)			
	Storage	-40...+85 °C (-40...+185 °F)			
Altitude		2000 m (6560 ft)			
Construction					
Insulating Material		Molded High Dielectric Material			
Enclosure		Transparent Dust Cover			
Contact Material		700-HK3 ₁ : Silver nickel (AgNi); 700-HKX ₁ : Silver Nickel + Gold Plating (AgNi + Au); 700-HKM ₁ : Silver Tin Oxide (AgSnO ₂)			
Terminal Markings on Socket		In accordance with EN 50005			
Sockets	Screw Terminal	1-Pole		2-Pole	
		700-HN121 (10 A @ 70 °C) 700-HN221 (16 A @ 50 °C, 12 A @ 70 °C)		700-HN122 (2 x 5 A @ 70 °C) 700-HN222 (2 x 8 A @ 70 °C)	
	Spring Clamp (Available September 2006)	700-HN223 (15 A @ 40 °C with 2 conductors per terminal) (10 A @ 70 °C with 1 conductor per terminal)		700-HN224 (2 x 8 A @ 70 °C)	
Approvals					
Certifications		CSA Certified, File 75088, UL Recognized, File E3125 Guide NLDX2/NLCX8, cULus Listed with Allen-Bradley sockets (File No. 3125 Guide NLDX/NLDX7), CE Marked			
Standards		EN61810-1, CSA 22.2 No. 14, UL 508			



Approximate Dimensions

Approximate Dimensions are shown in millimeters (inches). Approximate Dimensions are not intended to be used for manufacturing purposes.

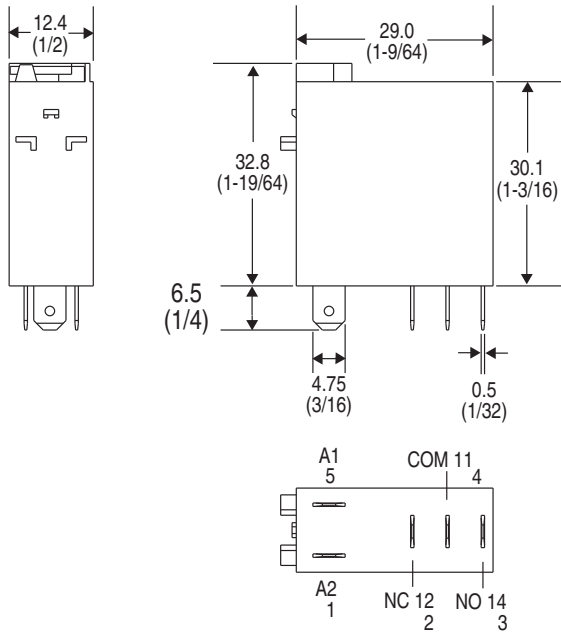

Cat. No. 700-HK36_ (SPDT)

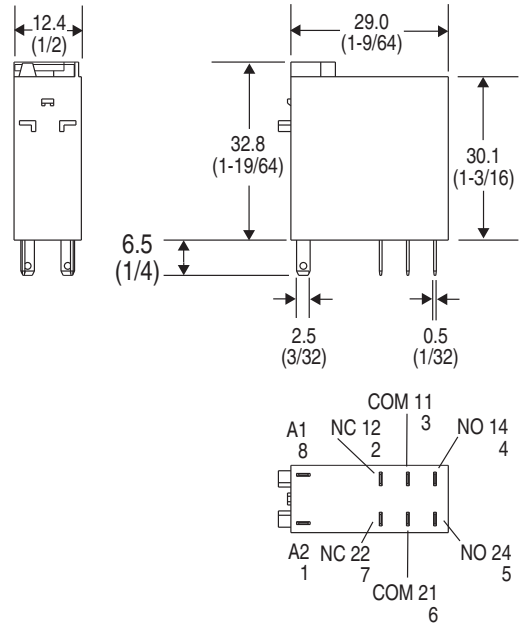

Cat. No. 700-HK32_ (DPDT)

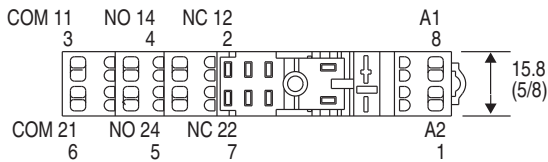

Cat. No. 700-HN224

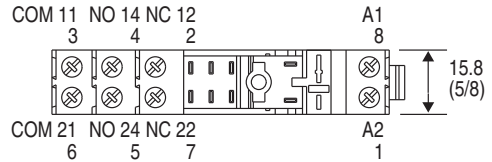

Cat. No. 700-HN222

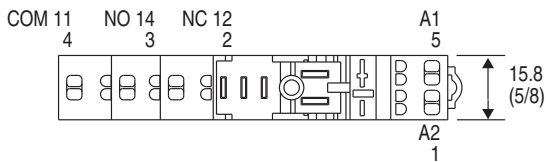

Cat. No. 700-HN223

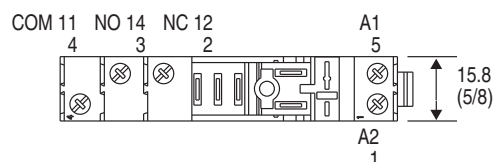

Cat. No. 700-HN221

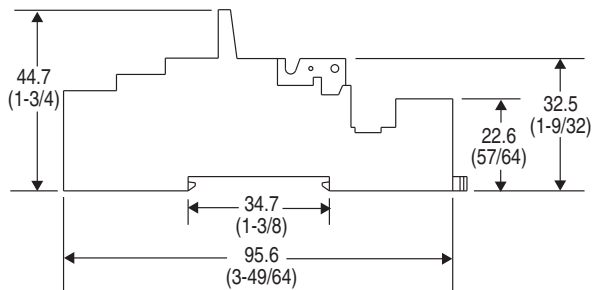

Cat. No. 700-HN223, 700-HN224
 Wire Size: 0.2 mm²...1.5 mm² (#24 AWG...#14 AWG)
 Either Solid or Stranded
 Strip Length: 8 mm (5/16 in)

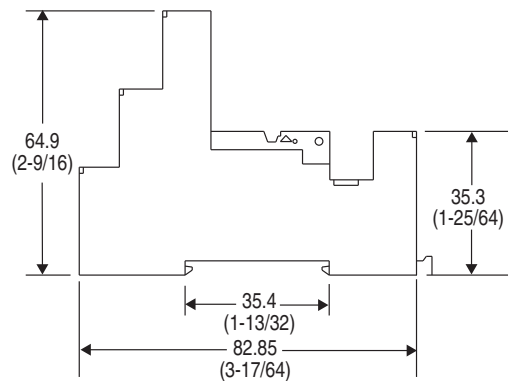

Cat. No. 700-HN221, 700-HN222
 Wire Size: 0.2 mm²...2.5 mm² (#24 AWG...#12 AWG)
 Either Solid or Stranded
 Strip Length: 8 mm (5/16 in), Torque: 0.8Nm (7.0 lb.-in.)

Bulletin 700-HK
Interposing/Isolation Relays
 Approximate Dimensions

Approximate Dimensions are shown in millimeters (inches). Approximate Dimensions are not intended to be used for manufacturing purposes.

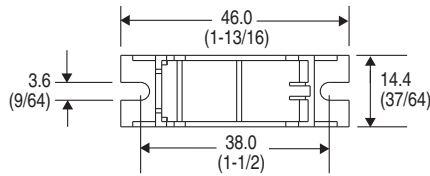

Cat. No. 700-HN226

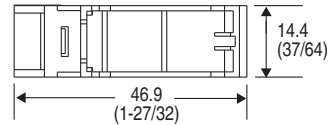

Cat. No. 700-HN227

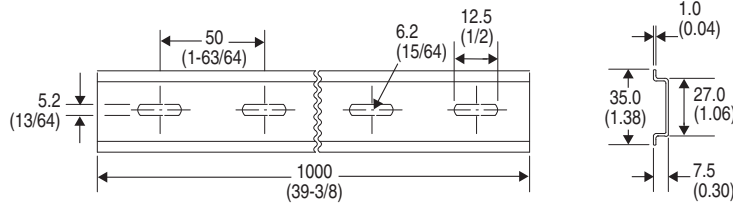
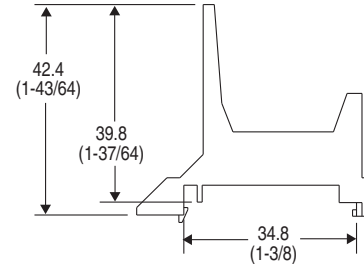
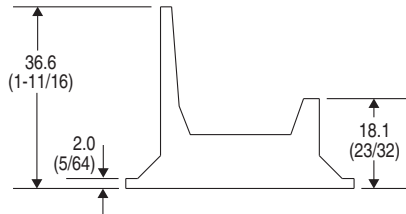

Cat. No. 199-DR4 DIN Mounting Rail Series B Has No Mounting Holes
 Cat. No. 199-DR1 DIN Mounting Rail Series B

Cat. No.	A	B	C	D	Approx. Shipping Wt.
199-DR1	35 (1-3/8)	27 (1-1/16)	7.5 (19/64)	1.02 (1/64)	1.85 kg (4.07 lb) (10/pkg)
199-DR4	35 (1-3/8)	27 (1-1/16)	15 (19/32)	2.3 (3/32)	3.68 kg (8 lb) (5/pkg)

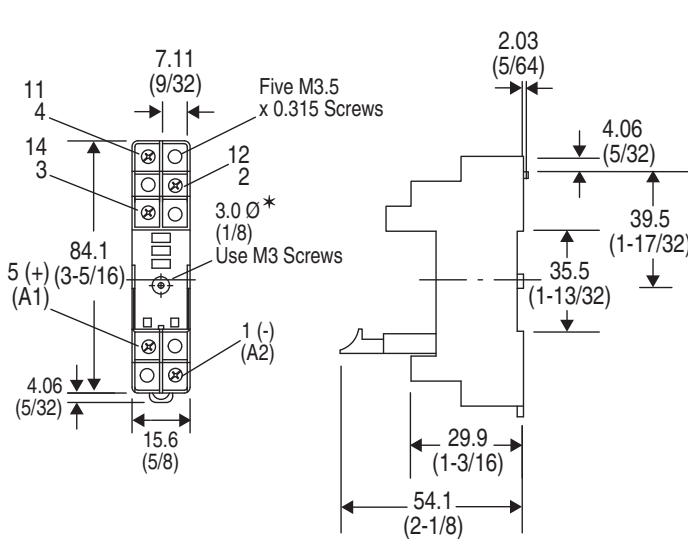

Cat. No. 700-HN121
 Wire Size: 2 x 2.5 mm²
 Single Wire – Up to #14 AWG
 Double Wire – 2 x 2.5 mm² (#2–14 AWG... #2–20 AWG)
 (Either Solid or Stranded)
 Strip Length: 9 mm (3/8 in.) – Torque: 0.8 N•m (7 lb•in)

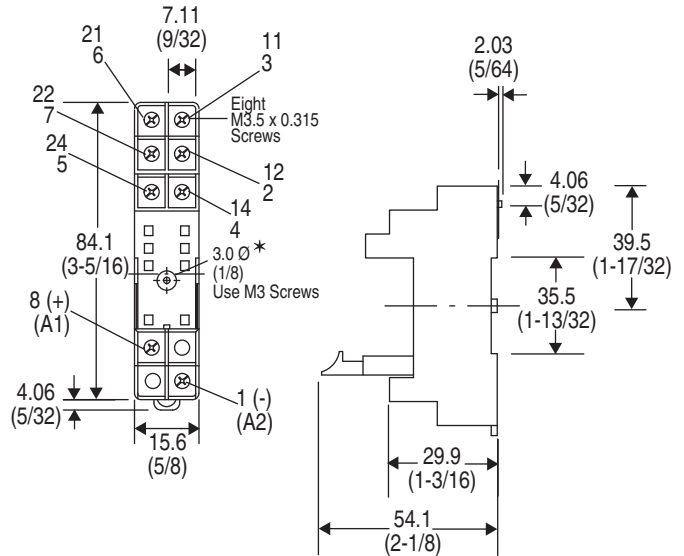

Cat. No. 700-HN122
 Wire Size: 2 x 2.5 mm²
 Single Wire – Up to #14 AWG
 Double Wire – 2 x 2.5 mm² (#2–14 AWG... #2–20 AWG)
 (Either Solid or Stranded)
 Strip Length: 9 mm (3/8 in.) – Torque: 0.8 N•m (7 lb•in)

* Holes required for mounting [3 mm (1/8 in.) diameter].

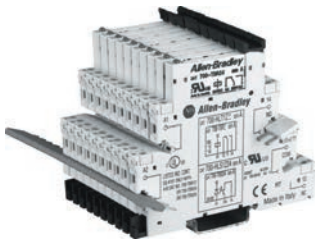

Bulletin 700-HL — "Terminal Block Relay"

- Relay and socket assembled interface modules for high density interposing or isolation applications
- Screw terminal and spring-clamp bases
- 6 A relay, choice of silver or gold contacts
- 2 A solid-state relay — DC output
- 1 A solid-state relay — AC output
- SPDT (relay), 1 N.O. (solid-state)
- Built-in retainer clip and snap-in marker lever
- Standard LED, reverse polarity protection, and surge protection *
- Externally replaceable relay modules
- Unique leakage current suppression version to address industry concerns of nuisance coil turn-on or contact non-drop out when connecting to PLCs with leakage current
- Available with hazardous location certification

Table of Contents

Product Selection this page

Accessories..... 9-46





Specifications..... 9-49

Approximate Dimensions..... 9-49

Standards Compliance and Certifications

See Specification table in this section, page 9-47.

Product Selection

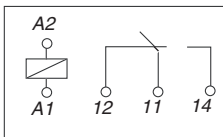
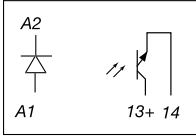
Standard built-in Features: • LED • Reverse Polarity Protection for DC Inputs • Coil Surge Protection *				
	Cat. No. 700-HLT1Z24	Cat. No. 700-HLT2Z24	Cat. No. 700-HLS1Z24	Cat. No. 700-HLS11Z24
Specifications				
Output Type	SPDT (1 C/O); $I_{th} = 6A\ddagger$		1 N.O. solid-state; $I_{th} = 2 A, 24V DC$ or $I_{th} = 1 A, 240V AC$	
Recommended Tightening Torque	0.5 N•m max. (4.4 lb•in)			
Wire Range	Screw Terminal: 0.14 mm ² ...2.5 mm ² (#26...#14 AWG), Spring Terminal: 0.2 mm ² ...2.5 mm ² (#24...#14 AWG)			
Approvals	UL, cULus, cURus, ABS, CE			





Assembled Devices	Pkg. Quantity	Cat. No. (Screw Terminals)	Cat. No. (Spring Clamp Terminals)	Pkg. Quantity	Cat. No. (Screw Terminals) (DC Output)	Cat. No. (Spring Clamp Terminals) (DC Output)	Cat. No. (Screw Terminals) (AC Output)
Input Voltage							
12V DC	10	* 700-HLT1Z12	700-HLT2Z12	—	—	—	—
24V DC	10	* 700-HLT1Z24	700-HLT2Z24	10	* 700-HLS1Z24	700-HLS2Z24	700-HLS11Z24
48V DC	10	* 700-HLT1Z48	700-HLT2Z48	10	* 700-HLS1Z48	700-HLS2Z48	700-HLS11Z48
12V AC/DC	10	700-HLT1U12	700-HLT2U12	—	—	—	—
24V AC/DC	10	700-HLT1U24	700-HLT2U24	—	—	—	—
48V AC/DC	10	700-HLT1U48	700-HLT2U48	—	—	—	—
110/125V AC/DC	10	700-HLT1U1	700-HLT2U1	10	* 700-HLS1U1	700-HLS2U1	700-HLS11U1
220...240V AC/DC	10	700-HLT1U2	700-HLT2U2	10	* 700-HLS1U2	700-HLS2U2	700-HLS11U2
240V AC	10	700-HLT1A2	—	—	—	—	—
Built-in LCSC (leakage current suppression circuit) 120V AC and 125V DC§	10	* 700-HLT1L1	—	10	* 700-HLS1L1	—	700-HLS11L1
Built-in LCSC (leakage current suppression circuit) 240V AC§	10	* 700-HLT1L2	—	10	* 700-HLS1L2	—	700-HLS11L2
Hazardous Location Certification 24V DC	10	700-HLT1Z24-EX	—	10	700-HLS1Z24-EX	—	—
Hazardous Location Certification 12V DC	10	700-HLT1Z12-EX	—	10	—	—	—
Hazardous Location Certification 110/125V AC/DC	10	700-HLT1U1-EX	—	10	700-HLS1U1-EX	—	—

* Reverse polarity on the output terminals of the solid-state relay will result in the output being "On" regardless of the state of the input voltage.
 * Electromechanical relay to solid-state relay interchangeability is possible.
 ‡ For Gold-plated contacts: Add the letter "X" at the end of the catalog number. For example: if Cat. No. 700-HLT1Z24 is required with gold plating, the new cat. no. is 700-HLT1Z24X.
 § Leakage current suppression up to 2.2 mA off state current.
 * Diode surge protection provided.

Interposing/Isolation Relays

Accessories

Accessories

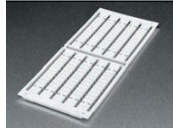
	Description	Pkg. Quantity	Socket Input Voltage	Cat. No.
 <p>Cat. No. 700-TBR24</p>	Replacement Relays Order must be for 20 relays or multiples of 20.	20	12V AC/DC	700-TBR12*
			24V AC/DC	700-TBR24*
			48V AC/DC	700-TBR48*
			110/125V AC/DC 220...240V AC/DC	700-TBR60*
 <p>Cat. No. 700-TBS24</p>	Replacement SSR 4-blade miniature relay for use with 1 N.O. SSR DC output. Order multiples of 20.	20	24V DC	700-TBS24
			48V DC, 110/125V AC/DC 220...240V AC/DC	700-TBS60
			24V DC	700-TBS124
			48V DC 110/125V AC/DC 220...240V AC/DC	700-TBS160
 <p>Cat. No. 700-TBJ20B</p>	20-Way Jumper Can be cut to required length. $I_{th} = 36$ A max per 20-way jumper.	1	Color	
			Red	700-TBJ20R
			Grey	700-TBJ20G
			Blue	700-TBJ20B
 <p>Cat. No. 700HN177</p>	End Barrier Used for visual inspection of groups, safe separation of neighboring 700-HL modules that end with jumpers.	10	Black	700-HN177
	Snap-in Marker These snap-in markers have a 6 x 10 mm surface and snap into the ejection lever for the relay.	100	Blank	1492-MC6X10
			Standard 1492-MC6X10	www.ab.com/catalogs for information
			Custom	⊛

* For gold-plated contacts: Add the letter "X" at the end of the catalog number. For example: if **Cat. No. 700-TBR24** is required with gold plating, the new cat. no. is 700-TBR24X.

⊛ Go to <http://www.ab.com/software/> and click on "Terminal Marking System and WinABMS" to download software. Create custom text, save file, and e-mail to your local Rockwell Automation sales office or Allen-Bradley distributor.

Note: Terminal block relay bases are not sold separately.

Cat. No. 700-HLT... (Relay Output)							
Electrical Ratings							
Pilot Duty Rating	B 300, R 300						
Rated Thermal Current (I_{th})	1-Pole — 6 A						
Rated Insulation Voltage (U_i)	250V IEC, 300V UL/CSA						
Contacts	Inductive	1-Pole					
	24V AC, 1-phase	30 A	▶] [◀	5 A	◀] [▶		
	120V AC, 1-phase	30 A		3 A			
	240V AC, 1-phase	15 A		1.5 A			
	Make, Break & Continuous V DC	24V DC				1.0 A	
	120V DC				0.2 A		
	240V DC				0.1 A		
Inductive Load	AC-15 250V, 3 A N.O. Contact, 1.5 A N.C. Contact DC-13 24V, 1 A N.O. and N.C. Contact						
Min. Permissible Contact Ratings	12V, 6 mA (72 mW) for Silver Contacts, 8V, 2.5 mA (20 mW) for Gold Contacts						
Permissible Coil Voltage Variation	Pickup:	85...110% of Nominal Voltage at 50 Hz 85...110% of Nominal Voltage at 60 Hz 80...110% of Nominal Voltage at DC				Must Dropout Voltage:	10% of Nominal Voltage at AC 5% of Nominal Voltage at DC
Power Consumption ±10%	AC	0.3 VA					
	DC	0.2 W					
Design Specification/Test Requirements							
Dielectric Withstand Voltage	Pole to Pole (VRMS)	1000V					
	Contact to Coil (VRMS)	4000V					
Input Voltage	12V AC/DC	24V AC/DC	48V AC/DC	120V AC/DC	240V AC/DC	120V LCSC	240V LCSC
Impedance (Ohms)	1 K	2 K	6 K	26 K	56 K	16 K	35 K
Mechanical							
Degree of Protection	IP20						
Mechanical Life Operations	1 x 10 ⁷						
Electrical Life Operations	6 A Resistive: 100 000 min. 24V DC, 1 A Inductive: 200 000 min. 120V AC 1 A Inductive: 300 000 min.						
Switching Frequency Operations (no-load)	10 cycles/sec						
Coil Voltages	See Overview/Product Selection						
Operating Time at Nominal Voltage at 20 °C (ms)	Pickup	7 ms					
	Dropout	3 ms					
Maximum Operating Rate (full load = 6 A)	6 cycles/min.						
Coil Surge Protection	Per EN 61000-4.5; Surge Immunity (801-5) Class III: 2 kV common and 1 kV differential mode						
Environmental							
Temperature	Operating	-40...+55 °C					
	Storage	-40...100 °C					
Altitude	2000 m (6560 ft)						
Construction							
Insulating Material	Molded High Dielectric Material						
Enclosure	Relay IP67						
Contact Material	Silver Tin Ox., AgSnO ₂ or Silver with Gold Plating, AgSnO ₂ + Au						
Terminal Markings on Socket	In accordance with EN50 0005						
Certifications	cULus Listed (File No. E3125, Guide NLDX/NLDX7) with Allen-Bradley socket, CE Marked, ABS (American Bureau of Shipping)						
Standards	EN60947-4-1, EN60947-5-1, CSA 22.2, UL 508, NEMA IEE MAC Compliant, ICS-2 Compliant Class 1, Zn 2, Groups IIC, Ex nC IIC T5 Ta < 55 °C						
Hazardous Location Approvals	UL Listed (UL 60079-15)	700-HLT1Z12-EX (12V DC supply) 700-HLT1Z24-EX, 700-HLS1Z24-EX (24V DC supply) 700-HLT1U1-EX, 700-HLS1U1-EX (110V/125V AC/DC supply)					
	CSA Certified* (CAN/CSA E60079-15)	700-HLT1Z12-EX (12V DC supply) 700-HLT1Z24-EX, 700-HLS1Z24-EX (24V DC supply)					

* Performance Data – See this catalog, Important 3.

* Product shall be installed in an enclosure providing at least IP54 protection. Provisions shall be made to prevent the rated voltage from being exceeded by transient disturbances of more than 40%.

Bulletin 700-HL
Interposing/Isolation Relays
 Specifications

Cat. No. 700-HLS... (Solid State Output)						
Electrical						
Rated Thermal Current (I_{th})	2 A (DC output)			1 A (AC output)		
Rated Insulation Voltage (U_i)	250V IEC, 300V UL/CSA					
Control Circuit	Min. Control Voltage	80% nominal voltage				
	Maximum Control Voltage	110% nominal voltage				
	Control Current	9 mA \pm 10% (24V) 4 mA \pm 10% (120/240V)				
	Release Voltage	0.4 x nominal voltage (24V), 0.35 x nominal voltage (120/240V)				
	Min. Control Circuit Resistance	3200 ohms (24V), 16k ohms (120V), 32k ohms (240V)		2500 ohms (24V), 12k ohms (120V), 24k ohms (240V)		
Outputs	Load Voltage Range	0...24V DC		24...240V AC		
	Max. Repetitive Blocking Voltage	33V		600V		
	Max. Switching Current (inductive/resistive)	2 A DC		1 A AC		
	On State Voltage Drop @ Max. Switching Current	<120 mV DC		<1V AC		
	Leakage Current	max. 100 μ A (@U = 24V)				
Power Consumption \pm 10%	AC	0.6 VA (120V), 1 VA (240V)				
	DC	0.2 W		0.3 W		
Design Specification/Test Requirements						
Dielectric Withstand Voltage	Pole to Pole (VRMS)	2500V				
	Contact to Coil (VRMS)	2500V				
Input Voltage	24V DC	48V DC	120V AC/DC	240V AC/DC	120V LCSC	240V LCSC
Impedance (Ohms)	2K	9 K	26 K	58 K	16 K	35 K
Mechanical						
Degree of Protection	IP20					
Input Voltages	See Overview/Product Selection					
Operating Time at Nominal Voltage at 20 °C (ms)	Turn on Time	30 μ s (DC only input voltage), 7 ms (AC/DC input voltage)				
	Drop Out Time	350 μ s (DC only input voltage), 10 ms (AC/DC input voltage)				
Maximum Operating Rate	300 Hz					
Environmental						
Temperature	Operating	-20...+55 °C				
	Storage	-40...70 °C				
Altitude	2000 m (6560 ft)					
Construction						
Insulating Material	Molded High-Dielectric Material					
Enclosure	Relay IP67					
Terminal Markings on Socket	In accordance with EN50 0005					
Certifications	cULus Listed (File No. E14843, Guide NLDX/NLDX7), CE Marked, ABS (American Bureau of Shipping)					
Standards	UL 508, CSA C22.2 No. 14, EN/IEC 60947-1, -5-1					
Hazardous Location Approvals	Class 1, Zn 2, Groups IIC, Ex nC IIC T5 Ta < 55 °C					
	UL Listed (UL 60079-15)	700-HLT1Z24-EX, 700-HLS1Z24-EX (24V DC supply) 700-HLT1U1-EX, 700-HLS1U1-EX (110V/125V AC/DC supply)				
	CSA Certified* (CAN/CSA 60079-15)	700-HLT1Z24-EX, 700-HLS1Z24-EX (24V DC supply)				

* Product shall be installed in an enclosure providing at least IP54 protection. Provisions shall be made to prevent the rated voltage from being exceeded by transient disturbances of more than 40%.



Approximate Dimensions

Approximate Dimensions are shown in millimeters (inches). Approximate Dimensions are not intended to be used for manufacturing purposes.

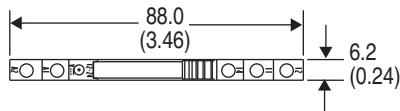
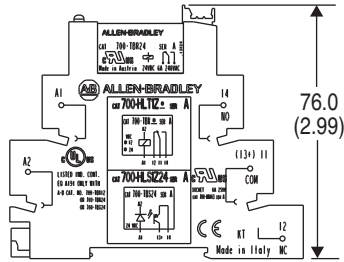

Bulletin 700-HL Screw Terminal Design
 Single Wire: 0.14 mm²...2.5 mm² (#26 AWG...14 AWG)
 Double Wire: 2 x 0.14 mm²...2 x 1.5 mm² (2 x #26 AWG...2 x 16 AWG)
 Wire Type: Solid or stranded, copper only
 Strip Length: 9 mm (11/32 in.). Torque: 0.5 N•m (4.4 lb•in)

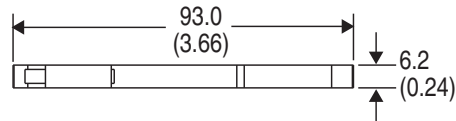
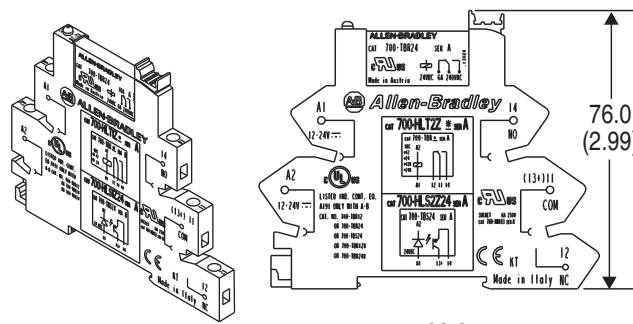

Bulletin 700-HL Spring Terminal Design
 Single Wire: 0.2 mm²...2.5 mm² (#24 AWG...#14 AWG)
 Wire Type: Solid or stranded, copper only
 Strip Length: 9 mm (11/32 in.)

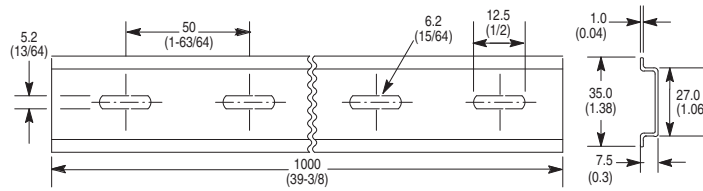

Cat. No. 199-DR1 DIN Mounting Rail Series B
Cat. No. 199-DR4 DIN Mounting Rail Series B Has No Mounting Holes

Cat. No.	A	B	C	D	Approx. Shipping Wt.
199-DR1	35 (1-3/8)	27 (1-1/16)	7.5 (19/64)	1.02 (1/64)	1.85 kg (4.07 lb) (10/pkg)
199-DR4	35 (1-3/8)	27 (1-1/16)	15 (19/32)	2.3 (3/32)	3.68 kg (8 lb) (5/pkg)

Interposing/Isolation Relays

Product Overview/Catalog Number Explanation



Bulletin 700-HL 2-Pole "Terminal Block Relay"

- Relay and socket assembled interface modules for high density interposing or isolation applications
- Screw terminal and spring-clamp bases
- 10 A relay, choice of silver or gold contacts
- DPDT (relay)
- Built-in retainer clip and snap-in marker lever
- Standard LED, reverse polarity protection, and surge protection
- Externally replaceable relay modules

Table of Contents

Product Selection 9-51
 Accessories..... 9-51
 Specifications..... 9-52
 Approximate
 Dimensions..... 9-53

Standards Compliance and Certifications

See Specification table in this section, page 9-52.

Catalog Number Explanation

700	-	HL	T	1	2	Z24	X*
Bulletin Number		Series Type	Relay Type	Terminal Type	Output	Supply Voltage	Gold-Plated Contact Option
700	-	HL	T	1	2	Z24	X*
Bulletin Number		a	b	c	d	e	f

a

Series Type	
Code	Description
HL	Terminal Block relay

c

Terminal Type	
Code	Description
1	Screw Terminal
2	Spring Clamp Terminal

e

Supply Voltage	
Code	Description
Z12	12V DC
Z24	24V DC
Z48	48V DC
U24	24V AC/DC
U1	110...125V AC/DC
U2	220...240V AC/DC

f*

Gold-Plated Contact Option	
Code	Description
Blank	None
X	Gold Plate

b

Relay Type	
Code	Description
T	EM Relay

d

Output	
Code	Description
2	DPDT (2 C/O), 14 mm

* For Gold-plated contacts: Add the letter "X" at the end of the catalog number. Example: Cat. No. 700-HLT12Z24 with gold plated contacts is catalog number 700-HLT12Z24X. The following relays are available with the gold-plated contact option: 700-HLT_Z24, 700-HLT_U24, 700-HLT_U1, and 700-HLT_U2.

- Standard built-in Features:
- LED
 - Reverse Polarity Protection for DC Inputs
 - Coil Surge Protection



Specifications

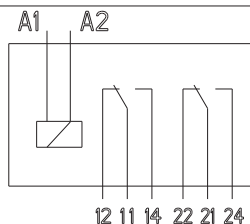

Output Type	DPDT (2 C/O); $I_{th} = 10$ A
Recommended Tightening Torque	0.6 N•m max. (5.3 lb•in.)
Wire Range	Screw Terminal: 0.2...2.5 mm ² (#24...14 AWG), Spring Terminal: 0.2...2.5 mm ² (#24...14 AWG)
Approvals	cULus, cURus, CE

Assembled Devices	Pkg. Quantity	Cat. No. (Screw Terminals)	Cat. No. (Spring Clamp Terminals)
Input Voltage			
12V DC	10	700-HLT12Z12	700-HLT22Z12
24V DC	10	700-HLT12Z24*	700-HLT22Z24*
48V DC	10	700-HLT12Z48	700-HLT22Z48
24V AC/DC	10	700-HLT12U24*	700-HLT22U24*
110/125V AC/DC	10	700-HLT12U1*	700-HLT22U1*
220...240V AC/DC	10	700-HLT12U2*	700-HLT22U2*

* For Gold-plated contacts: Add the letter "X" at the end of the catalog number. Example: **Cat. No. 700-HLT12Z24** with gold plated contacts is **Cat. No. 700-HLT12Z24X**. The following relays are available with the gold-plated contact option: 700-HLT_2Z24, 700-HLT_2U24, 700-HLT_2U1, and 700-HLT_2U2.

	Description	Pkg. Quantity	Socket Input Voltage	Cat. No.
 Cat. No. 700-TBR224	Replacement Relays Order must be for 20 relays or multiples of 20.	20	12V DC	700-TBR212
			24V AC/DC	700-TBR224*
			48V DC	700-TBR248
			110/125V AC/DC 220...240V AC/DC	700-TBR2110*
 Cat. No. 700-TBJ08B	8-Way Jumper Can be cut to required length. $I_{th} = 10$ A max per 8-way jumper.	1	Color	
			Red	700-TBJ08R
			Grey	700-TBJ08G
Blue	700-TBJ08B			
 Cat. No. 700-HN177	End Barrier Used for visual inspection of groups, safe separation of neighboring 700-HL modules that end with jumpers.	10	Black	700-HN177
			Blank	1492-MS6X12
 Cat. No. 700-HN177	Snap-in Marker These snap-in markers have a 6 x 12 mm surface and snap into the ejection lever for the relay.	100	Standard 1492-MS6X12	www.ab.com/catalogs for information
			Custom	⊛

* For gold-plated contacts: Add the letter "X" at the end of the catalog number. For example: if Cat. No. 700-TBR224 is required with gold plating, the new cat. no. is 700-TBR224X.

⊛ Go to <http://www.ab.com/software/>, click on "Terminal Marking System and WinABMS" to download software. Create custom text, save file, and e-mail to your local Rockwell Automation sales office or Allen-Bradley distributor.

Note: Terminal Block Relay bases are not sold separately.

Bulletin 700-HL
Interposing/Isolation Relays
Specifications

Cat. No. 700-HLT...2-Pole (Relay Output)							
Electrical Ratings							
Rated Thermal Current (I_{th})		2-Pole — 10 A					
Rated Insulation Voltage (U_i)		250V IEC, 300V UL/CSA					
Contacts	Inductive V AC UL	120V AC	AC-15, 3.0A B 300, 3.0 A		1/4 HP (186 W), 1-phase		
		240V AC	AC-15, 3.0 A B 300, 1.5 A		1/2 HP (373 W), 1-phase		
	Inductive V DC	24V DC	DC-13, 2.0 A				
		125V DC	DC-13, 0.3 A				
		250V DC	DC-13, 0.2 A				
	Resistive Make, Break and Continuous	250V AC	10 A				
		24V DC	10 A				
250V DC		0.28 A					
Min. Permissible Contact Ratings		12V, 10 mA (120 mW) for Silver Contacts, 5V, 1 mA (50 mW) for Gold Contacts					
Permissible Coil Voltage Variation		Pickup: 85...110% of Nominal Voltage at 50 Hz 85...110% of Nominal Voltage at 60 Hz 80...110% of Nominal Voltage at DC				Must Dropout Voltage: 10% of Nominal Voltage at AC 5% of Nominal Voltage at DC	
Design Specification/Test Requirements							
Dielectric Withstand Voltage		Pole to Pole (VRMS)	1000V				
		Contact to Coil (VRMS)	5000V				
		Adjacent Contacts (VRMS)	2500V				
Input Voltage		12V AC/DC	24V AC/DC	48V DC	120V AC/DC	240V AC/DC	
Impedance (Ohms)		1 K	2 K	3 K	34 K	72 K	
Power Consumption ±10%		AC	N/A	0.5V A	N/A	0.4V A	0.8V A
		DC	0.4 W	0.5 W	0.8 W	0.5 W	0.7 W
Mechanical							
Degree of Protection		IP20					
Mechanical Life Operations		3 x 10 ⁷					
Electrical Life Operations		250V AC/24V DC, 8 A Resistive: 100 000 min. 24V DC, 10 A Resistive: 6000 min. 250V DC, 0.28 A Resistive: 6000 min. 250V AC, 10 A Resistive: 30 000 min.					
Switching Frequency Operations (no-load)		1200 cycles/sec					
Coil Voltages		See Overview/Product Selection					
Operating Time at Nominal Voltage at 20 °C (ms)		Pickup	typical 10 ms				
		Dropout	typical 10 ms				
Maximum Operating Rate (full load = 6 A)		6 cycles/min.					
Environmental							
Temperature		Operating	-40...+60 °C				
		Storage	-40...+100 °C				
Altitude		2000 m (6560 ft)					
Construction							
Insulating Material		Molded High-Dielectric Material					
Enclosure		Relay RT II — flux-proof, pollution degree 2 installation environment					
Contact Material		AgNi 90/10 or AgNi 90/10 + Au					
Terminal Markings on Socket		In accordance with EN50 0005					
Certifications		cULus Listed (File No. E3125, Guide NRNT/NRNT7), CE Marked					
Standards		UL 508, CSA C22.2 No. 14, EN/IEC 60947-1, -5-1					

* Performance Data – See this catalog, Important 3



Approximate Dimensions

Approximate dimensions are shown in millimeters (inches). Approximate dimensions are not intended to be used for manufacturing purposes.

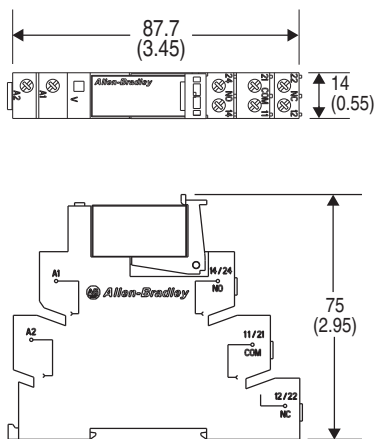

Bulletin 700-HL Screw Terminal Design
 Single Wire: 0.14 mm²...2.5 mm² (#26 AWG...14 AWG)
 Double Wire: 2 x 0.14 mm²...2 x 1.5 mm² (2 x #26 AWG...2 x 16 AWG)
 Wire Type: Solid or stranded, copper only
 Strip Length: 9 mm (11/32 in). Torque: 0.5 N•m (4.4 lb•in)

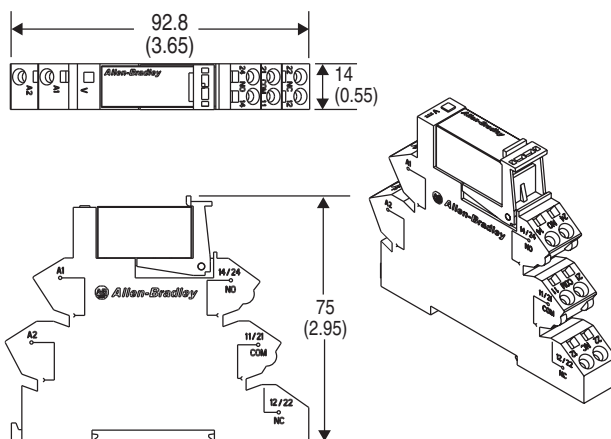

Bulletin 700-HL Spring Terminal Design
 Single Wire: 0.2 mm²...2.5 mm² (#24 AWG...#14 AWG)
 Wire Type: Solid or stranded, copper only
 Strip Length: 9 mm (11/32 in)

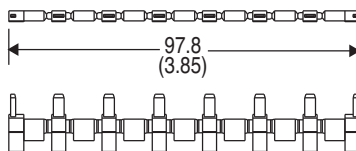

Bulletin 700-TBJ08_ 8-Way Jumper

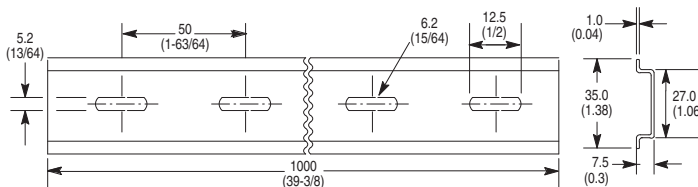

Cat. No. 199-DR1 DIN Mounting Rail Series B
Cat. No. 199-DR4 DIN Mounting Rail Series B Has No Mounting Holes

Cat. No.	A	B	C	D	Approx. Shipping Wt.
199-DR1	35 (1-3/8)	27 (1-1/16)	7.5 (19/64)	1.02 (1/64)	1.85 kg (4.07 lb) (10/pkg)
199-DR4	35 (1-3/8)	27 (1-1/16)	15 (19/32)	2.3 (3/32)	3.68 kg (8 lb) (5/pkg)

Interposing/Isolation Relays

Product Overview/Catalog Number Explanation/Product Selection

	<p>Bulletin 700-HLF — Terminal Block Timing Relay</p> <ul style="list-style-type: none"> • Relay and socket assembled modules for high-density applications • Screw terminal bases • 6 A relay, choice of silver or gold contacts • SPDT (relay) • Four timing functions • Time range from 0.1 sec...6 hr • Built-in retainer clip and snap-in marker lever • Standard LED, reverse polarity protection, and surge protection ⚡ • Externally replaceable relay modules 	<p>Table of Contents</p> <p>Product Selection this page</p> <p>Accessories..... 9-55</p> <p>Specifications..... 9-56</p> <p>Approximate Dimensions..... 9-57</p> <p>Standards Compliance and Certifications</p> <p>See Specification table in this section, page 9-56.</p>
---	--	--

Catalog Number Explanation

700	- HL	F	1	U24	X*
Bulletin Number	Series Type	Relay Type	Terminal Type	Supply Voltage	Gold-Plated Contact Option

a	c	e*														
Series Type	Terminal Type	Gold-Plated Contact Option														
<table border="1"> <thead> <tr> <th>Code</th> <th>Description</th> </tr> </thead> <tbody> <tr> <td>HL</td> <td>Terminal Block relay</td> </tr> </tbody> </table>	Code	Description	HL	Terminal Block relay	<table border="1"> <thead> <tr> <th>Code</th> <th>Description</th> </tr> </thead> <tbody> <tr> <td>1</td> <td>Screw Terminal</td> </tr> </tbody> </table>	Code	Description	1	Screw Terminal	<table border="1"> <thead> <tr> <th>Code</th> <th>Description</th> </tr> </thead> <tbody> <tr> <td>Blank</td> <td>None</td> </tr> <tr> <td>X</td> <td>Gold Plate</td> </tr> </tbody> </table>	Code	Description	Blank	None	X	Gold Plate
Code	Description															
HL	Terminal Block relay															
Code	Description															
1	Screw Terminal															
Code	Description															
Blank	None															
X	Gold Plate															
b	d															
Relay Type	Supply Voltage															
<table border="1"> <thead> <tr> <th>Code</th> <th>Description</th> </tr> </thead> <tbody> <tr> <td>F</td> <td>Timing Relay</td> </tr> </tbody> </table>	Code	Description	F	Timing Relay	<table border="1"> <thead> <tr> <th>Code</th> <th>Description</th> </tr> </thead> <tbody> <tr> <td>U24</td> <td>24V AC/DC</td> </tr> </tbody> </table>	Code	Description	U24	24V AC/DC							
Code	Description															
F	Timing Relay															
Code	Description															
U24	24V AC/DC															

* For Gold-plated contacts: Add the letter "X" at the end of the catalog number. Example: Cat. No. 700-HLF1U24 with gold plated contacts is catalog number 700-HLF1U24X.

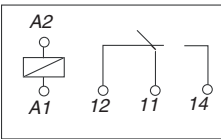

Product Selection

<p>Standard built-in Features:</p> <ul style="list-style-type: none"> • LED • Reverse Polarity Protection for DC Inputs • Coil Surge Protection ⚡ 	 <p style="text-align: center;">Cat. No. 700-HLF1U24</p>
<p>Specifications</p>	
<p>Output Type</p>	<p>SPDT (1 C/O); $I_{th} = 6A\ddagger$</p>
<p>Recommended Tightening Torque</p>	<p>0.5 N•m max. (4.4 lb•in)</p>
<p>Wire Range</p>	<p>Screw Terminal: 0.14 mm²...2.5 mm² (#26...#14 AWG)</p>
<p>Approvals</p>	<p>cULus, cURus, CE</p>

Assembled Devices		
Input Voltage	Pkg. Quantity	Cat. No.
24V AC/DC	10	700-HLF1U24

⚡ Diode surge protection provided.

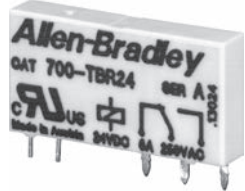
Accessories

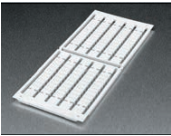
	Description	Pkg. Quantity	Socket Input Voltage	Cat. No.
	Replacement Relays Order must be for 20 relays or multiples of 20.	20	24V AC/DC	700-TBR24*
 Cat. No. 700-TBJ20B	20-Way Jumper Can be cut to required length. $I_{th} = 36$ A max per 20-way jumper.	1	Color	
			Red	700-TBJ20R
			Grey	700-TBJ20G
 Cat. No. 700HN177	End Barrier Used for visual inspection of groups, safe separation of neighboring 700-HL modules that end with jumpers.	10	Black	700-HN177
 Cat. No. 700HN177	Snap-in Marker These snap-in markers have a 6 x 10 mm surface and snap into the ejection lever for the relay.	100	Blank	1492-MC6X10
			Standard 1492-MC6X10	www.ab.com/catalogs for information
			Custom	*

* For gold-plated contacts: Add the letter "X" at the end of the catalog number. For example: if **Cat. No. 700-TBR24** is required with gold plating, the new cat. no. is 700-TBR24X.

* Go to <http://www.ab.com/software/> and click on "Terminal Marking System and WinABMS " to download software. Create custom text, save file, and e-mail to your local Rockwell Automation sales office or Allen-Bradley distributor.

Note: Terminal block timing relay bases are not sold separately.

700-HLF Function and Connection Diagrams

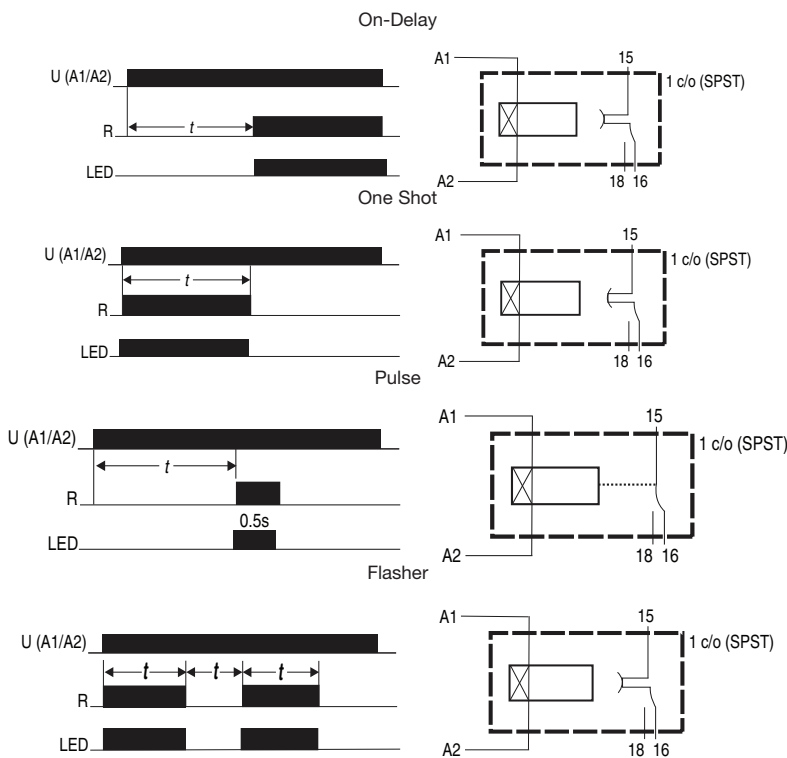

Bulletin 700-HLF
Interposing/Isolation Relays
 Specifications

Specifications

Cat. No. 700-HLF... (Relay Output)					
Electrical Ratings					
Pilot Duty Rating	B 300, R 300				
Rated Thermal Current (I_{th})	1-Pole — 6 A				
Rated Insulation Voltage (U _i)	250V IEC, 300V UL/CSA				
Contacts	Inductive	1-Pole			
	24V AC, 1-phase	30 A	▶ ◀	5 A	
	120V AC, 1-phase	30 A		3 A	
	240V AC, 1-phase	15 A		1.5 A	
	Make, Break & Continuous V DC	24V DC		1.0 A	
		120V DC		0.2 A	
240V DC		0.1 A			
Inductive Load	AC-15 250V, 3 A N.O. Contact, 1.5 A N.C. Contact DC-13 24V, 1 A N.O. and N.C. Contact				
Min. Permissible Contact Ratings	12V, 6 mA (72 mW) for Silver Contacts, 8V, 2.5 mA (20 mW) for Gold Contacts				
Permissible Coil Voltage Variation	Pickup:	85...110% of Nominal Voltage at 50 Hz 85...110% of Nominal Voltage at 60 Hz 80...110% of Nominal Voltage at DC		Must Dropout Voltage: 10% of Nominal Voltage at AC 5% of Nominal Voltage at DC	
Power Consumption ±10%	AC/DC	0.5 VA			
Design Specification/Test Requirements					
Dielectric Withstand Voltage	Pole to Pole (VRMS)	1000V			
	Contact to Coil (VRMS)	4000V			
Input Voltage	24V AC/DC				
Impedance (Ohms)	2 K				
Mechanical					
Degree of Protection	IP20				
Mechanical Life Operations	1 x 10 ⁷				
Electrical Life Operations	6 A Resistive: 100 000 min. 24V DC, 1 A Inductive: 200 000 min. 120V AC 1 A Inductive: 300 000 min.				
Switching Frequency Operations (no-load)	10 cycles/sec				
Coil Voltages	See Overview/Product Selection				
Timer Functions	On-Delay, One Shot, Pulse and Flasher				
Timer Settings	0.1...3 s, 3...60 s, 1...20 min, and 0.3...6 hr				
Timer Adjustments	Min and Max adjustments with Potentiometer				
Timer Accuracy	Repeatability 1%, Recovery Time < 50 ms, Setting Accuracy Full Range 5%				
Coil Surge Protection	Per EN 61000-4.5; Surge Immunity (801-5) Class III: 2 kV common and 1 kV differential mode				
Environmental					
Temperature	Operating	-40...55 °C			
	Storage	-40...100 °C			
Altitude	2000 m (6560 ft)				
Construction					
Insulating Material	Molded High Dielectric Material				
Enclosure	Relay IP67				
Contact Material	Silver Tin Ox., AgSnO ₂ or Silver with Gold Plating, AgSnO ₂ + Au				
Terminal Markings on Socket	In accordance with EN50 0005				
Certifications	cULus Listed (File No. E3125, Guide NLDX/NLDX7) with Allen-Bradley socket, CE Marked				
Standards	EN60947-4-1, EN60947-5-1, CSA 22.2, UL 508, NEMA IEE MAC Compliant, ICS-2 Compliant				

* Performance Data – See this catalog, Important 3.

* Product shall be installed in an enclosure providing at least IP54 protection. Provisions shall be made to prevent the rated voltage from being exceeded by transient disturbances of more than 40%.



Approximate Dimensions

Approximate Dimensions are shown in millimeters (inches). Approximate Dimensions are not intended to be used for manufacturing purposes.

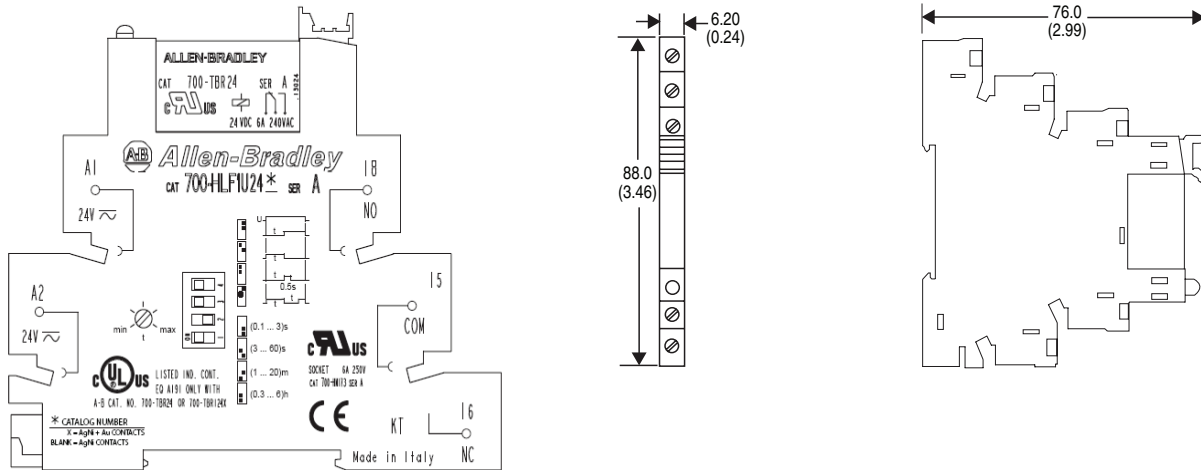

Bulletin 700-HLF Screw Terminal Design
 Single Wire: 0.14 mm²...2.5 mm² (#26 AWG... 14 AWG)
 Double Wire: 2 x 0.14 mm²...2 x 1.5 mm² (2 x #26 AWG...2 x 16 AWG)
 Wire Type: Solid or stranded, copper only
 Strip Length: 9 mm (11/32 in.). Torque: 0.5 N•m (4.4 lb•in)

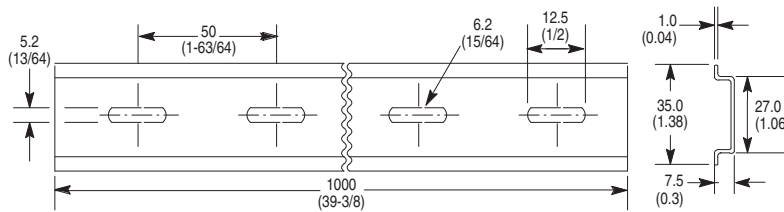

Cat. No. 199-DR1 DIN Mounting Rail Series B
Cat. No. 199-DR4 DIN Mounting Rail Series B Has No Mounting Holes

Cat. No.	A	B	C	D	Approx. Shipping Wt.
199-DR1	35 (1-3/8)	27 (1-1/16)	7.5 (19/64)	1.02 (1/64)	1.85 kg (4.07 lb) (10/pkg)
199-DR4	35 (1-3/8)	27 (1-1/16)	15 (19/32)	2.3 (3/32)	3.68 kg (8 lb) (5/pkg)

Interposing/Isolation Relays

Product Overview/Product Selection



Bulletin 700-HP — (PCB) "Pin Style" Relay

- 8 A contact ratings
- DPDT/ (2 c/o) contacts
- Plug-in PIN style (PCB) terminals (5 mm pinning)
- Choice of standard silver nickel contacts, or silver nickel with gold-plated contacts

Table of Contents

Product Selection this page

Accessories..... 9-59

Specifications..... 9-60

Approximate Dimensions..... 9-61

Standards Compliance and Certifications

See Specification table in this section, page 9-60.







Product Selection

Slim Line Relay with "PIN Style" Terminations

	Description	Contact Rating	Wiring Diagrams		Coil Voltage	Package Quantity	Cat. No.
			U.S./Canada	International			
	DPDT 2-Pole 2 Form C AgNi + Au Gold Plated Contacts Sockets	8 A			6V AC	10	700-HPX2A06
					12V AC	10	700-HPX2A12
					24V AC	10	700-HPX2A24
					120V AC	10	700-HPX2A1
					240V AC	10	700-HPX2A2
					6V DC	10	700-HPX2Z06
	DPDT 2-Pole 2 Form C AgNi Contacts Sockets	8 A			12V DC	10	700-HPX2Z12
					24V DC	10	700-HPX2Z24
					48V DC	10	700-HPX2Z48
					110V DC	10	700-HPX2Z1
					6V AC	10	700-HP32A06
					12V AC	10	700-HP32A12
Bulletin 700-HP DPDT Sockets	8 A			24V AC	10	700-HP32A24	
				120V AC	10	700-HP32A1	
				240V AC	10	700-HP32A2	
				6V DC	10	700-HP32Z06	
				12V DC	10	700-HP32Z12	
				24V DC	10	700-HP32Z24	
				48V DC	10	700-HP32Z48	
				110V DC	10	700-HP32Z1	

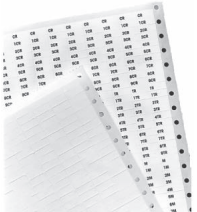

Accessories

	Description	Pkg. Quantity	Cat. No.
	Diode Surge Suppressor Voltage Range: 6...220V DC used with 700-HN123 socket	10	700-ADR
	Diode with LED Surge Suppressor Voltage Range: 6...24V DC used with 700-HN123 socket	10	700-ADL1R
	Diode with LED Surge Suppressor Voltage Range: 28...60V DC used with 700-HN123 socket	10	700-ADL2R
	Diode with LED Surge Suppressor Voltage Range: 110...220V DC used with 700-HN123 socket	10	700-ADL3R
	Diode with LED Surge Suppressor Voltage Range: 6...24V AC used with 700-HN123 socket	10	700-AV1R
	Varistor with LED Surge Suppressor Voltage Range: 110...240V AC used with 700-HN123 socket	10	700-AV3R
	RC Surge Suppressor Voltage Range: 6...24V AC/DC used with 700-HN123 socket	10	700-AR1
	RC Surge Suppressor Voltage Range: 110...240V AC/DC used with 700-HN123 socket	10	700-AR2
	Timing Module On-Delay or One-Shot selectable voltage range: 12...24V AC/DC used with sockets that accept plug-in accessory modules.	1	700-AT3
	Timing Module On-Delay or One-Shot selectable voltage range: 110...125V AC used with sockets that accept plug-in accessory modules.		700-AT3A1
	Timing Module On-Delay or One-Shot selectable voltage range: 230...240V AC used with sockets that accept plug-in accessory modules.		700-AT3A2
 <p>Cat. No. 700-HN123</p>	Screw Terminal Socket — Panel or DIN Rail Mounting 8-pin miniature socket for use with 2-pole, Bulletin 700-HP relays. Incorporates coil and contact separation.	10	700-HN123
	 <p>Cat. No. 700-HN180</p>	8-Way Jumper can be cut to required length. Rated 10 A – 250V	1
Red 700-HN180R			
Gray 700-HN180G			
Blue 700-HN180B			
Cat. No. 700-HN119	Plastic Retainer and Ejection Lever For use with the 700-HN123 sockets Built-in ability to accept 1492 snap-in markers	10	700-HN119
Cat. No. 700-HN230	Spring Clamp Terminal Socket — Panel or DIN Rail Mounting 8-pin miniature socket for use with 2-pole, Bulletin 700-HP relays. Incorporates coil and contact separation.	10	700-HN230
Cat. No. 700-HN232	Plastic Retainer and Ejection Lever For use with the 700-HN230 sockets Built-in ability to accept 1492 snap-in markers	10	700-HN232
 <p>Cat. No. 199-DR1</p>	DIN (#3) symmetrical hat rail 35 x 7.5 x 1 m	10	199-DR1
 <p>Snap-in markers</p>	Relay Identification Snap-in Markers Note - These markers can only be used when the Plastic Retainer and Ejection Lever accessory (part # 700-HN119) is used because the markers snap into the Ejection Lever (and not into the relay itself).	5	1492-MS5X12
		5	1492-MS6X9
		5	1492-MS6X12
		5	1492-MS8X9
		5	1492-MS8X12
		100	1492-MP-Blank
	Pre-Printed Identification Tags — contains 10 sheets of pre-printed and blank tags. Each sheet contains 13 sets of the markings CR...9CR, TR...9TR, M...9M, F, R, 1S, and 117 blank tags. Tags are peel-off with sticky backing for easy placement on relays.	10	700-N40
			700-N41

Bulletin 700-HP
Interposing/Isolation Relays
 Specifications

Bulletin 700-HP Pin Style (PCB) Slim Line Relay, Socket, and Retainer Clip Reference Chart

Relay Type	Socket Cat. No.	Retainer Clip Cat. No.
700-HPX2	700-HN123	700-HN119
700-HP32	700-HN123	700-HN119

Specifications *

Cat. No. 700-HP...			
Electrical Ratings			
Pilot Duty Rating*		C300, R300	
Rated Thermal Current (I_{th})		2-Pole — 8A	
Rated Insulation Voltage (U_i)		250V IEC, 300V UL/CSA	
Contacts	Inductive	2-Pole	
		▶][◀	◀][▶
	120V AC, 1-phase	15 A	1.5 A
	240V AC, 1-phase	7.5 A	0.75 A
	General Purpose	8 A, 277V AC	
	Resistive	8 A, 30V DC	
Min. Permissible Contact Ratings		700-HP32 = 300 mW (5V, 5 mA) 700-HPX = 50 mW (5V, 5 mA)	
Permissible Coil Voltage Variation		Pickup: 80...110% of Nominal Voltage at 50 Hz 80...110% of Nominal Voltage at 60 Hz 73...150% of Nominal Voltage at DC	Must Drop-out Voltage: 20% of Nominal Coil Voltage AC 10% of Nominal Coil Voltage DC
Sealed Power Consumption ±10%	AC Coils	Max. Allowable Leakage OFF 25% of VA‡ 1.2 VA 50 Hz 1.0 VA 60 Hz	
	DC Coils	Max. Allowable Leakage of 10% of W 0.5 W	
Design Specification/Test Requirements			
Dielectric Withstand Voltage for One Minute	Pole to Pole (VRMS)	1000V AC	
	Contact to Coil (VRMS)	5000V AC	
Mechanical			
Degree of Protection		Open Type (Sockets)	
Mechanical Life Cycles		10 x 10 ⁶ (AC Coils), 20 x 10 ⁶ (DC coils)	
Switching Frequency Operations		1800/hr (no load)	
Coil Voltages		See Overview/Product Selection	
Operating Time at Nominal Voltage at 20 °C (ms)	Pickup	12	
	Dropout	4	
Maximum Operating Rate		16 Ops/s (full load)	
Vibration	Enclosure	5 G	
	Fragility	2.5 G	
Shock	Endurance	50 G	
	Fragility	15 G	
Max. Socket Torque		0.5 N•m (4.4 lb•in)	
Environmental			
Temperature	Operating	-40...+85 °C	
	Storage	-45...+100 °C	
Altitude		2000 m (6560 ft)	
Construction			
Insulating Material		Molded High-Dielectric Material	
Enclosure		Transparent Dust Cover	
Contact Material		Silver Nickel, (AgNi) (700-HP3), Silver Nickel + Gold Plating (AgNi + Au) (700-HPX)	
Terminal Markings on Socket		In accordance with EN50 0005	
Sockets		2-Pole	
		700-HN123	
Approvals			
Certifications		cURus Recognized (File No. E3125, Guide NLDX2/NLDX8), cULus Listed when used with Bulletin 700-HN123 socket (File No. E3125, Guide NLDX/NLDC7), CSA Certified (files 229473), CE Marked, LR Certified	
Standards		UL 508, CSA 22.2 No. 14, EN 61812-1, EN 60255-23	

* Performance Data – See this catalog, Important- 3.

⊛ NEMA Rating Chart is in publication 700-SG003*

‡ The inrush VA equals 1.5 times the sealed VA.



Approximate Dimensions

Approximate Dimensions are shown in millimeters (inches). Approximate Dimensions are not intended to be used for manufacturing purposes.

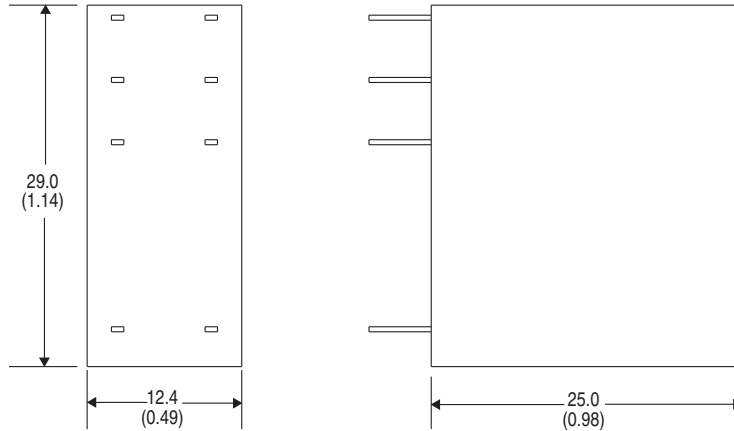

Bulletin 700-HP Relay

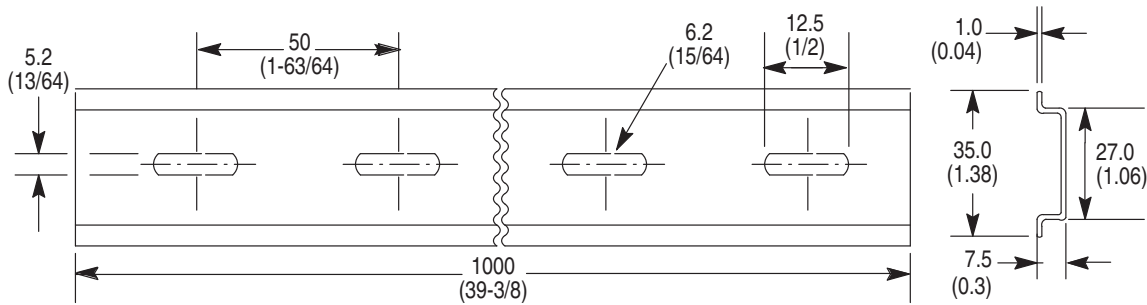

Cat. No. 700-HN123
 Single Wire: 0.2.....2.5 mm² (#24.....14 AWG)
 Double Wire: 2 X 0.2.....2 X 2.5 mm² (#2 X 24.....2 X 14 AWG)
 Wire Type: solid or stranded, copper only
 Strip Length: 7 mm (9/32 in.), Torque: 0.5 N•m (4.4 lb•in)

Cat. No.	A	B	C	D	Approx. Shipping Wt.
199-DR1	35 (1-3/8)	27 (1-1/16)	7.5 (19/64)	1.02 (1/64)	1.85 kg (4.07 lb) (10/pkg)
199-DR4	35 (1-3/8)	27 (1-1/16)	15 (19/32)	2.3 (3/32)	3.68 kg (8 lb) (5/pkg)



Cat. No. 700-HN123
 Single Wire: 0.2.....2.5 mm² (#24.....14 AWG)
 Double Wire: 2 X 0.2.....2 X 2.5 mm² (#2 X 24.....2 X 14 AWG)
 Wire Type: solid or stranded, copper only
 Strip Length: 7 mm (9/32 in.), Torque: 0.5 N•m (4.4 lb•in)

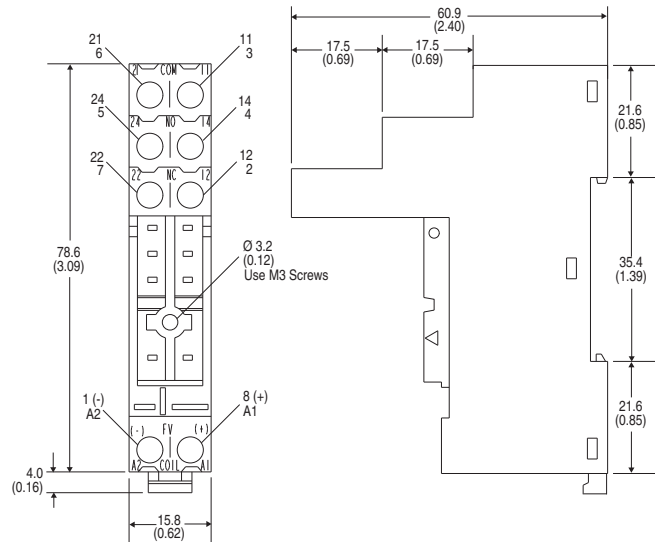

DIN Rail Mounted Timing Relays

Overview/Product Selection



Bulletin 700-FE — Economy Timing Relay

- Adjustable function and timing range timing relays
- DIN Rail mounted without cost of socket
- 17.5 mm wide, multi-function or single function
- Available as 1 N.O. or SPDT contact output, 5 A
- Timing ranges from 0.05 s...10.0 hr
- Coil surge protection

Table of Contents

Product Selection this page
 Accessories..... this page
 Specifications..... 9-64
 Approximate
 Dimensions..... 9-65

Standards Compliance and Certifications

See Specification table in this section, page 9-64.

Product Selection

Multi-Function

This device offers you the flexibility of selecting one of 4 single timing functions.

Operating Mode	Contact Output	Timing Range	Input Voltage	Cat. No.
ON-delay, OFF-delay, One Shot, Flasher (repeat cycle starting with pulse)	1 N.O.	0.05 s...10 hr (6 settings)‡	24V AC/DC * 110...240V AC 50/60 Hz	700-FEM1TU22
ON-delay, OFF-delay, One Shot, Flasher (repeat cycle starting with pulse)	SPDT (1 C/O)	0.05 s...10 hr (6 settings)‡	24V...48V AC/DC 24...240V AC 50/60 Hz	700-FEM3TU23

Single-Function

This device offers you one specific timing function.

Operating Mode	Contact Output	Timing Range‡	Input Voltage	Cat. No.
ON-delay	1 N.O.	0.05 s...10 hr (6 settings)	24V AC/DC * 110...240V AC 50/60 Hz	700-FEA1TU22
	SPDT (1 C/O)	0.05 s...10 hr (6 settings)	24V...48V AC/DC 24...240V AC 50/60 Hz	700-FEA3TU23
OFF-delay	1 N.O.	0.05 s...10 hr (6 settings)	24V AC/DC * 110...240V AC 50/60 Hz	700-FEB1TU22
	SPDT (1 C/O)	0.05 s...10 hr (6 settings)	24V...48V AC/DC 24...240V AC 50/60 Hz	700-FEB3TU23
One Shot	1 N.O.	0.05 s...10 hr (6 settings)	24V AC/DC * 110...240V AC 50/60 Hz	700-FED1TU22
	SPDT (1 C/O)	0.05 s...10 hr (6 settings)	24V...48V AC/DC 24...240V AC 50/60 Hz	700-FED3TU23
Fleeting OFF-delay	SPDT (1 C/O)	0.05 s...10 hr (6 settings)	24V...48V AC/DC 24...240V AC 50/60 Hz	700-FEE3TU23
Flasher (repeat cycle starting with pulse)	1 N.O.	0.05 s...10 hr (6 settings)	24V AC/DC * 110...240V AC 50/60 Hz	700-FEF1TU22
	SPDT (1 C/O)	0.05 s...10 hr (6 settings)	24V...48V AC/DC 24...240V AC 50/60 Hz	700-FEF3TU23
Pulse Converter	SPDT (1 C/O)	0.05 s...10 hr (6 settings)	24V...48V AC/DC 24...240V AC 50/60 Hz	700-FEL3TU23

* Voltage is either 24V AC 50/60 Hz or 24V DC.

‡ Time ranges: 0.05 s...1 s, 0.5...10 s, 0.05...1 min, 0.5...10 min, 0.05...1 hr, 0.5...10 hr.

Special Functions

Operating Mode	Contact Output	Timing Range*	Input Voltage	Cat. No.
Star-Delta	2 N.O. with 1 Common	0.15 s...10 min (4 settings)	24V...48V AC/DC 24...240V AC 50/60 Hz	700-FEY2QU23

* Time ranges: 0.15...3 s, 0.5...10 s, 3 s...1 min, 30 s...10 min.

Accessories

	Description	Pkg. Quantity	Cat. No.
	Panel Mounting Adapter For surface mounting according to drilling plan EN 50 002	5	199-FSA
	Label Sheet 105 self-adhesive paper labels each, 6 x 17 mm	10	100-FMS

700-FE Function and Connection Diagrams

(A) On-Delay

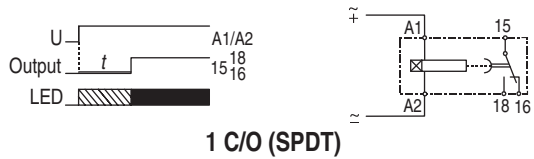
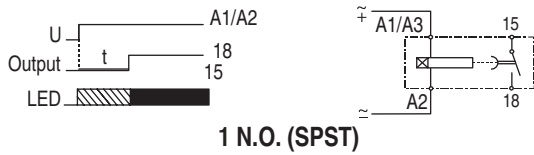

(D) One Shot

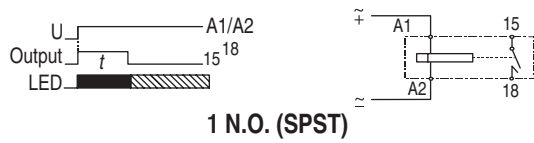

(E) Fleeting Off-Delay

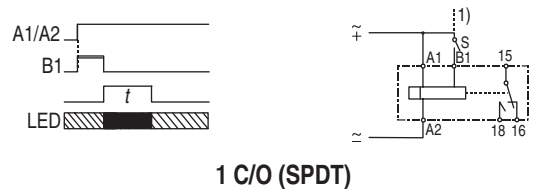

(Y) Star-Delta Timing Relay



Bi-Color LED: 1 C/O (SPDT) or 1 N.O. Contact Timers

LED U = green: Supply voltage available.
 LED Relay = red: Output is energized.

(B) Off-Delay

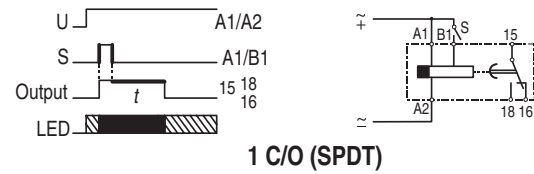
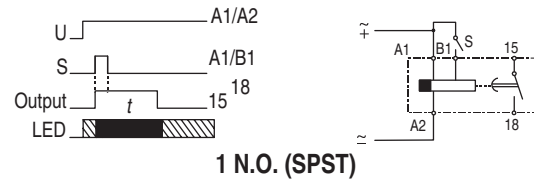

(F) Flasher (Repeat Cycle Starting with Pulse)

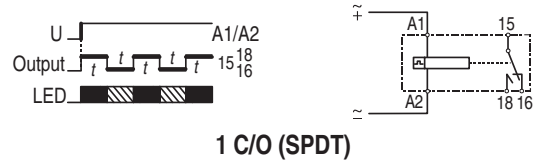
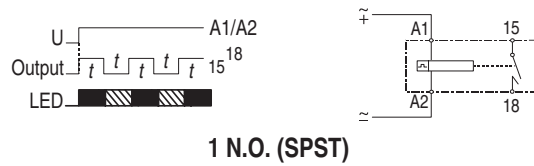

(L) Pulse Converter

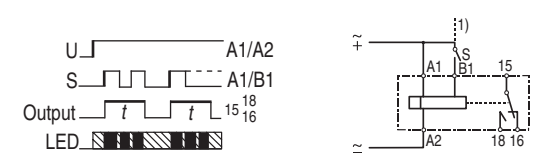



Single Color LED: 2 N.O. with Common

ON = green
 OFF = red

Bulletin 700-FE
DIN Rail Mounted Timing Relays
 Specifications

Specifications*

Time Characteristics (according to VDE 0435, part 2021)

			1 N.O.		SPDT
Setting Accuracy		±5% of full scale			
Repeatability		±1% of setting (typical)			
Tolerance		By voltage: ±0.01%/ΔU By temperature: ±0.25%/°C		By voltage: ±0.001%/ΔU By temperature: ±0.025%/°C	
Supply					
Supply Voltage		24V AC/DC* and 110...240V AC, 50/60 Hz		24...48V DC and 24...240V AC, 50/60 Hz	
Voltage Tolerance	AC	-15%/+10%			
	DC	-15%/+20%			
Power Consumption		0.5 W at 24V DC, 5 VA at 240V AC			
Time Energized		100%			
Reset Time		100 ms			
Cable Length (Supply Voltage Control)		Max. 250 m (750 feet)			
Pulse Control (B1)					
Impulse Duration		≥ 250 ms		≥ 50 ms (AC), ≥ 30 ms (DC)	
Input Voltage		supply voltage range			
Input Current		1 mA			
Cable Length		Max. 250 m without parallel load between B1 and A2 Max. 50 m with load (< 3 kΩ) between B1 and A2			
Outputs					
Contact Type		1 N.O. contact		1 Form C – SPDT contact	
Dielectric Withstand Voltage	Contact-to-coil	4000 V			
	Power	1250 VA			
Switching Capacity	According to IEC 947-5-1	AC-1	5 A /250V AC (resistive load)		
		AC-14	1 A/250V AC (inductive load)		
		DC-13	1 A/24V DC (inductive load)		
According to UL 508		NEMA D300 - 1 A/300V AC			
Short-Circuit Resistance		6 A gL (Fast Blow Fuse)			
Life	Mechanical	20 million operations			
	Electrical	0.4 million at 1 A/250V AC, resistive 0.4 million at 0.5 A/250V AC, cos φ = 0.4 0.4 million at 1 A/24V DC, resistive			
State Indicator		1 Bi-Color LED (Supply; Relay)			
Certifications		cULus Listed (File No. E14840, Guide NKCR/NKCR7), CE Marked			
Standards		EN/IEC 60947-1, EN/IEC 60947-5-1, UL 508, CSA 22.2 No. 14			

* Performance Data - See this catalog, Important- 3

* Voltage is either 24V DC or AC 50/60 Hz.



DIN Rail Mounted Timing Relays

Specifications/ Approximate Dimensions

General Specifications

	1 N.O.	SPDT
Insulation Characteristics	2 kV AC/50 Hz test voltage according to VDE 0435 and 4 kV 1.2/50 μs surge voltage according to IEC 60947-1 between all inputs and outputs	
EMC/Interference Immunity	The following requirements are fulfilled: Surge capacity of the supply voltage according to IEC 61000-4-5: Level 3 Burst according to IEC 61000-4-4: Level 3 ESD discharge according to IEC 61000-4-2: Level 3	
EMC/Emission	electromagnetic fields according to EN 55 022: Class B	
Safe Isolation	according to VDE 0106 T 101	
Climatic Withstand	56 cycles (24 hr) at 25...40 °C and 95% relative humidity according to IEC 60068-2-30	
Vibration Resistance	4 g in three axes at 10...500 Hz, test FC according to IEC 60068-2-6	
Shock Resistance	50 g according to IEC 68-2-27	
Protection Class IEC 60947-1	Enclosure: IP 40 Terminal: IP 20	
Weight	60 g	60 g
Certifications	cULus, CE Certified	cULus, Germanischer Lloyd, CE Certified
Ambient Temperature	Open: -25...+60 °C Enclosed: -25...+45 °C Storage: -40...+85 °C	
Connections	Screw terminal M3 for Pozidriv No.1, Phillips and slotted screws No.2. suitable for power screw-driver. Rated tightening torque 8.8 lb.-in. (max. 1.0 Nm) For terminal cross-sections of 1 x 0.5 mm ² ...2 x 1.5 mm ² (solid) or 2 x 1.5 mm ² (stranded with sleeve), #20...14 AWG. Finger protection according to EN 50274	
Mounting	For surface mounting in any position; snap-on mounting on 35 mm DIN Rail or by adapter and two screws (M4 type)	
Disposal	Synthetic materials without dioxin according to EC/EFTA-Notification No. 93/0141/D electrical contacts are AgCdO	

* Voltage is either 24V DC or AC 50/60 Hz.

Approximate Dimensions

Approximate dimensions are shown in millimeters (inches). Dimensions are not intended to be used for manufacturing purposes.

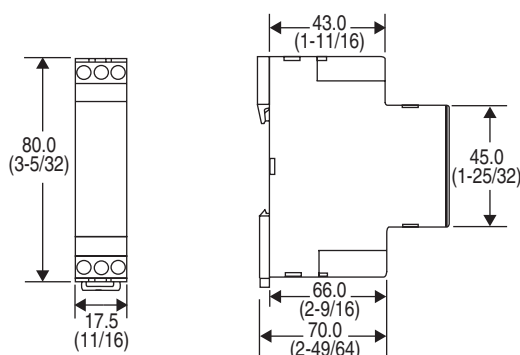

Cat. No. 700-FE...

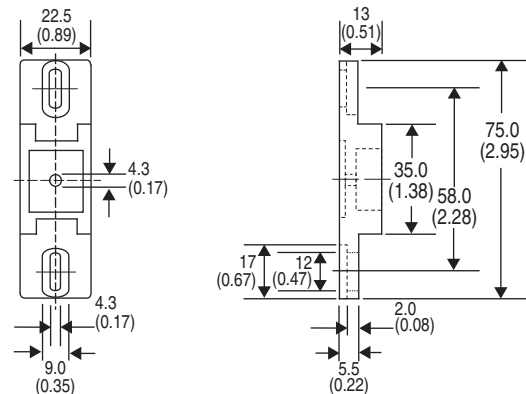

Cat. No. 199-FSA...

DIN Rail Mounted Timing Relays

Product Overview/Product Selection



Bulletin 700-FS — High Performance Timing Relay

- Adjustable function and timing range timing relays
- DIN Rail mounted without cost of socket
- 22.5 mm wide multi-function or single functions
- Available as SPDT or DPDT contact output, 8 A
- Timing Ranges From 0.05 s...60 hr
- Coil surge protection
- Hazardous location version available

Table of Contents

Product Selection 9-67
 Accessories..... 9-68
 Connection
 Diagrams 9-69
 Specifications..... 9-72

Standards Compliance and Certifications

See Specification table in this section, 9-72.

Catalog Number Explanation

700	- FS	H	3	U	U23
Bulletin Number	Type of Relay	Operating Mode	Contact Output	Timing Range	Input Voltage

Single-Function (With SPDT 1 C/O contacts)

700-FS	A	3	A	U23
	<i>a</i>	<i>b</i>	<i>c</i>	<i>d</i>

a

Operating Mode	
Code	Description
A	On-delay*
B	Off-delay*
C	On- and off-delay*
D	One shot*
E	Fleeting off-delay*
F	Flasher (repeat cycle starts with pulse)*
G	Flasher (repeat cycle starts with pause)*
I	On-delay pulse generator*
J	On-delay (pulse controlled)*
K	One shot/watch dog (pulse controlled)*
L	Pulse converter*

b

Contact Output	
All functions:	
3 One changeover contact (SPDT)	1 C/O

c

Timing Range	
Code	Description
A	0.05...1 s
B	0.15...3 s
C	0.5...10 s
D	1.5...30 s
E	0.05...1 min
F	0.15...3 min
G	0.5...10 min
H	1.5...30 min
I	0.05...1 hr
J	0.15...3 hr
K	0.5...10 hr
L	3.0...60 hr
U	0.05 s...60 hr*

d

Input Voltage	
Code	Description
Z12	12V DC
U23	24...48V DC 24...240V AC 50/60 Hz

* Preferred availability item.
 * Valid for functions "A" and "B" only.

Single Function (With 2PDT 2 C/O contacts)

Operating Mode	Contact Output	Timing Range	Input Voltage	Cat. No.
On-delay	(DPDT) 2 C/O	0.05 s...60 hr ‡	12V DC	700-FSA4UZ12
On-delay	(DPDT) 2 C/O		24...48V DC 24...240V AC, 50/60 Hz	700-FSA4UU23
Off-delay	(DPDT) 2 C/O		12V DC	700-FSB4UZ12
Off-delay	(DPDT) 2 C/O		24...48V DC 24...240V AC, 50/60 Hz	700-FSB4UU23

‡ The time range of "0.05 s...60 hr" is selectable in 12 smaller ranges plus an ON and OFF function for maintenance needs.
 Note: Information for hazardous location versions of this product (-EX) is available on the Industrial Controls Catalog website: www.ab.com/catalogs.

Single Function With Hazardous Location Certification ⚡ (With SPDT 1 C/O contacts)

Operating Mode	Contact Output	Timing Range	Input Voltage	Cat. No.
One Shot / Watch Dog (Pulse Controlled)	(SPDT) 1 C/O	0.05 s...1 s	24...48V DC	700-FSK3AU23-EX
		0.5 s...10 s	24...240V AC 50/60 Hz	700-FSK3CU23-EX

Multi-Function

(This device allows the flexibility of selecting one of 8 single timing functions.)



Operating Mode	Contact Output	Timing Range	Input Voltage	Cat. No.
Multi-function timing relays 8 Single-functions: A, B, C, D, E, F, I, and L ON and OFF function additional (for installation and maintenance) note: See connection diagrams for further description.	(SPDT) 1 C/O	0.05 s...60 hr	12V DC	700-FSM3UZ12
	(SPDT) 1 C/O		24...48V DC 24...240V AC 50/60 Hz	700-FSM3UU23
	(DPDT) 2 C/O		12V DC	700-FSM4UZ12
	(DPDT) 2 C/O		24...48V DC 24...240V AC 50/60 Hz	700-FSM4UU23

Note: Information for hazardous location versions of this product (-EX) is available on the Industrial Controls Catalog website: www.ab.com/catalogs.

Multi-Function With Hazardous Location Certification ⚡

(This device allows the flexibility of selecting one of 8 single timing functions.)

Operating Mode	Contact Output	Timing Range	Input Voltage	Cat. No.
M Multi-function timing relays 8 Single-functions: A, B, C, D, E, F, I, and L ON and OFF function additional (for installation and maintenance) Note: See connection diagrams for further description.	(SPDT) 1 C/O	0.05 s...60 h*	24...48V DC 24...240V AC 50/60 Hz	700-FSM3UU23-EX
	(DPDT) 2 C/O			700-FSM4UU23-EX

Temp. Code T4A 2A 32VDC MAX.		
	II 3 G, EEx nL IIC T4 DEMKO 04 ATEX 0404974X 2A 32VDC MAX. Ta ≤ 70 °C	Ind. Cont. Eq. for Hazardous Location Listed 87SL Class 1, Div. 2, Groups A,B,C,D Class 1, Zn 2, Group IIC

Mounting: Product shall be installed in an enclosure constructed in accordance with the requirements of EN50021.

DIN Rail Mounted Timing Relays

Product Selection/Accessories

Special Function



Operating Mode	Contact Output	Timing Range	Input Voltage	Cat. No.
Flasher (repeat cycle starting with pulse or pause)	(SPDT) 1 C/O	0.05 s...60 hr*	12V DC	700-FSH3UZ12
			24...48V DC 24...240V AC 50/60 Hz	700-FSH3UU23
		2 x 0.05 s...60 hr (2 ranges)	12V DC	700-FSH3VZ12
			24...48V DC 24...240V AC, 50/60 Hz	700-FSH3VU23
OFF-delay without supply voltages (True OFF-delay)†	(SPDT) 1 C/O	0.15 s...10 min*	24...240V DC	700-FSQ3QU18
	(DPDT) 2 C/O		24...240V AC 50/60 Hz	700-FSQ4QU18
Star-Delta	2 N.O. + 1 Common	0.5 s...10 s	24...48V DC	700-FSY2CU23
		1.5...30 s	24...240V AC 50/60 Hz	700-FSY2DU23
		0.05 s...1 min		700-FSY2EU23
		0.15...3 min		700-FSY2FU23
		0.5...10 min		700-FSY2GU23

* The time range of "0.05 s...60 hr" is selectable in 12 smaller ranges plus an ON and OFF function for maintenance needs.

* This time range is selectable in four smaller ranges: 0.15 s...2.5 s, 0.5 s...10 s, 4 s...80 s, 30 s...10 min.



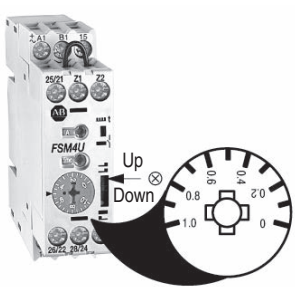

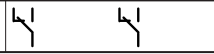
† Due to shock during shipment, the state of the contacts should be verified before initial use. Minimum power on time is 800 msec

Multi-Function Timing Relay Function and Time Range Settings

Description	SPDT	DPDT
 <p>Multi-function timing relays 700-FSM3U includes 10 setting functions:</p> <ul style="list-style-type: none"> (A) On-Delay (B) Off-Delay (C) On- and Off-Delay (D) One shot (E) Fleeting Off-Delay (F) Flasher (repeat cycle starts with pulse) (I) On-Delay pulse generator (L) Pulse converter (On) ON-Function§ (Off) OFF-Function§ <p>Note: Switch ⊗ is on DPDT relays only. When switch is down, one contact is instantaneous and one is timed. When switch is up, both contacts are timed.</p>		
<p>Multi-Time Setting Range 0.05 s...60 h</p> <ul style="list-style-type: none"> (1 s) 0.05...1 s (3 s) 0.15...3 s (10 s) 0.5...10 s (1 min) 0.05...1 min (3 min) 0.15...3 min (10 min) 0.5...10 min (1 hr) 0.05...1 hr (3 hr) 0.15...3 hr (10 hr) 0.5...10 hr (60 hr) 3...60 hr 		

§ For installation and maintenance.

Accessories

Description	Pkg. Quantity	Cat. No.
 <p>Setting Knob with Scale (for time setting without tools)</p>	10	700-FSK
 <p>Panel Mounting Adapter For surface mounting according to drilling plan EN 50 002</p>	5	199-FSA
 <p>Label Sheet 105 self-adhesive paper labels each, 6 x 17 mm</p>	10	100-FMS
 <p>Marking Tag Sheet 160 perforated paper labels each, 6 x 17 mm, to be used with a transparent cover</p>	10	100-FMP
<p>Transparent Cover To be used with marking tag sheets</p>	100	100-FMC
<p>Marking Tag Adapters To be used with marking tag: System 1492 W</p>	100	* 100-FMA2

* Cat. No. 100-FMA2 is only a marking tag carrier. Please refer to the Terminal Block Accessories section, page 12-90 of this publication for appropriate marker cards to be used with this carrier.

Connection Diagrams

(A) On-Delay

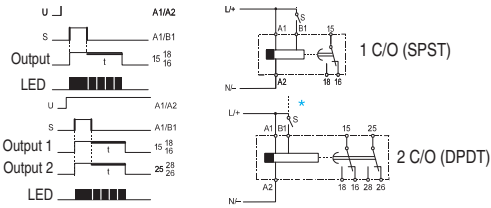

(B) Off-Delay (Min. Pulse AC 50 ms...DC 30 ms)

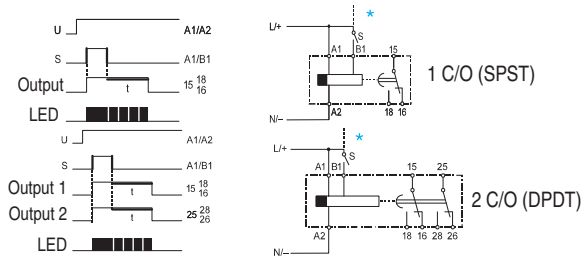

(C) On- and Off-Delay

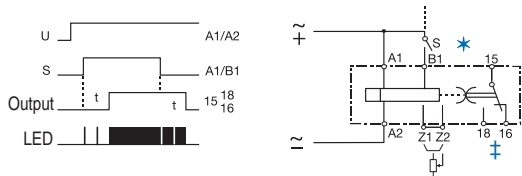

(D) One Shot

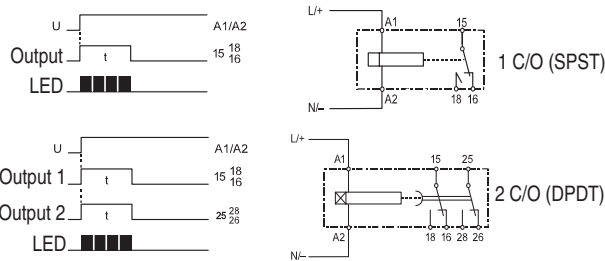

(E) Fleeting Off-Delay (Min. Pulse AC 50 ms...DC 30 ms)

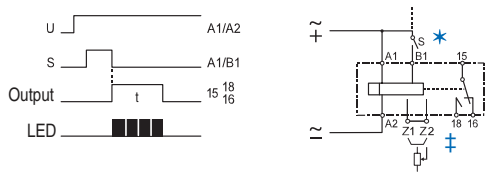

(F) Flasher (Repeat Cycle Starts with Pulse)

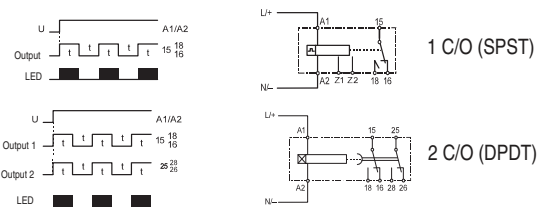

(G) Flasher (Repeat Cycle Starts with Pause)

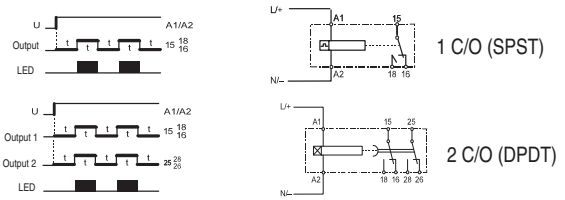

(I) On-Delay Pulse Generator

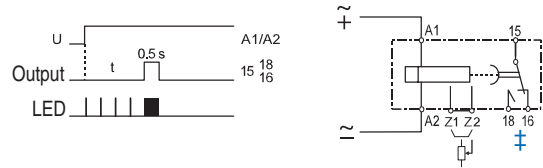

(J) On-Delay (Pulse Controlled)

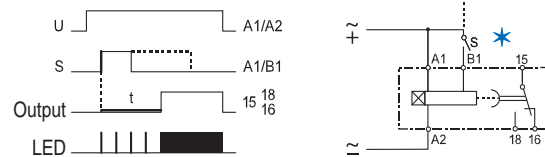

(K) One Shot/Watch Dog (Pulse Controlled)

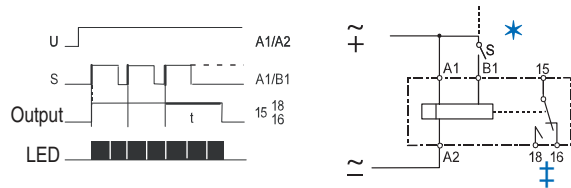

(On) ON-Function (Off) OFF-Function

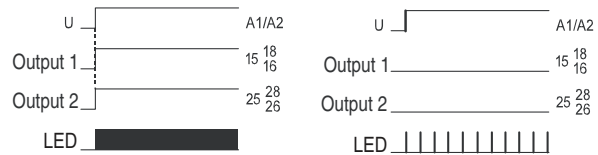

(L) Pulse Converter (Min. Pulse AC 50 ms...DC 30 ms)

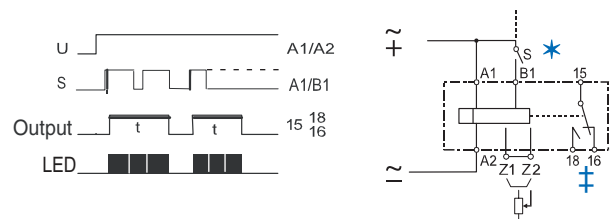

Cleverly Designed Function Display LED (Green)

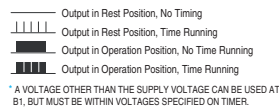

* A voltage other than the supply voltage can be used at B1, but must be within voltages specified on timer.
 * Output 2 is selectable as instantaneous contact with sliding switch (⊗) on front panel (instantaneous when switch is down, timed when switch is up).
 ‡ Available on multifunction "M," and single function "A" or "B" option timing relays along with code "4" (2PDT contacts). Bridge or potentiometer 10 kΩ, 0.25 W min. (low voltage) for external time setting. Set timer dial to 0.0.

DIN Rail Mounted Timing Relays

Function and Connection Diagrams

Special Function Flasher (Repeat Cycle Starting with Pulse or Pause) Timing Relays

Description

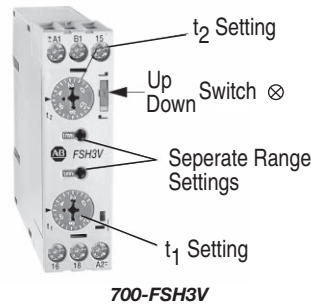
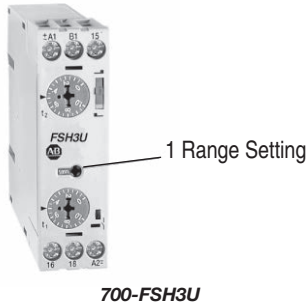

Supply Voltages (A1/A2)

Z12 12V DC

U23 24...48V DC, 24...240V AC, 50/60 Hz

Function Diagram / Connection Diagram

(H) Flasher (Repeat Cycle Starting with Pulse or Pause)

The repeat cycle timer permits different settings for on and off times. The following operating modes are possible:

- Oscillating mode; repeat cycle starts with voltage applied at A1 and B1, and continues to repeat until voltage is off.
- One cycle mode; started by energizing B1 with voltage on A1 and A2.
- Output starts with pulse or pause (switch ⊗ Up or Down).
- 700-FSH3U provides (1) range setting for t_1 and t_2 .
700-FSH3V provides (2) range settings for t_1 and t_2 .

Supply Voltage Controlled, Oscillating Mode Starting with Pause — Switch ⊗ is Up

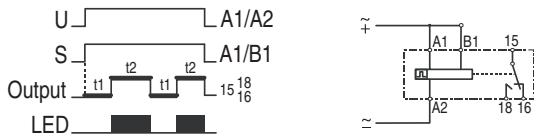

Supply Voltage Controlled, Oscillating Mode Starting with Pulse — Switch ⊗ is Down

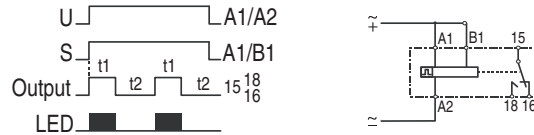

Pulse Controlled, Output Starts With Pause (Min. Pulse AC 50 ms — DC 30 ms) — Switch ⊗ is Up One Cycle Mode — Voltage Supplied at A1 and A2, then Pulsing “s” to Energize B1 will Initiate One Cycle.

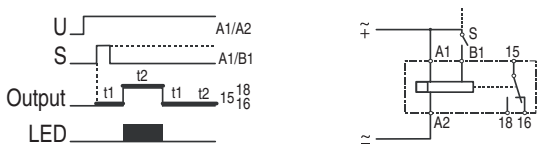

Pulse Controlled, Output Starts with Pulse (Min. Pulse AC 50 ms — DC 30 ms) — Switch ⊗ is Down One Cycle Mode — Voltage Supplied at A1 and A2, then Pulsing “s” to Energize B1 will Initiate One Cycle.

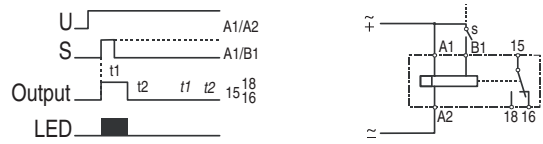

9 Note: If B1 is pulsed, a one full time cycle consisting of t_1 and t_2 is completed.

LED Operation Chart \bar{N} Green LED

- LED Output at Shelf State, No Timing - LED OFF
- LED Output at Shelf State, Time is Running - LED Flashing
- LED Output NO Contact is Closed, No Timing - LED On
- LED Output NO Contact is Closed, Time is Running - LED Long Flashing



DIN Rail Mounted Timing Relays

Function and Connection Diagrams

Function Diagram / Connection Diagram

(Q) Off-Delay without Supply Voltage (True Off-Delay) — When input power is turned on, the output contact changes state. When the power is removed, the time delay begins. The output contact returns to shelf state at the end of the time delay.

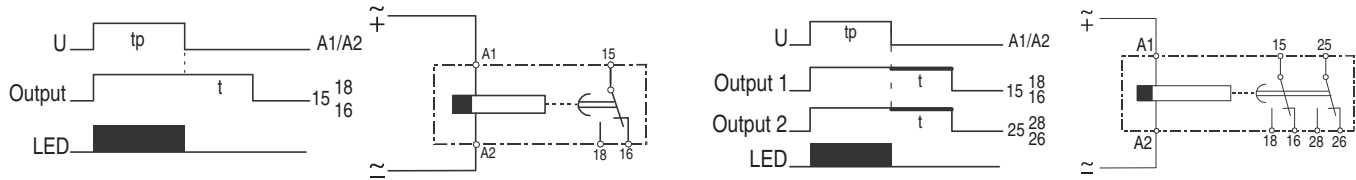

Note: Min. pulse (tp) required:
800 ms

(Y) Star-Delta Timing Relay — When power is applied, the output contact 17/18(Y) changes state. After the time setting, the output contact 17/18(Y) returns to shelf state. After the fixed time (50... 60 ms), the output contact 17/28Δ changes state. Both output contacts return to shelf state whenever the power is removed.

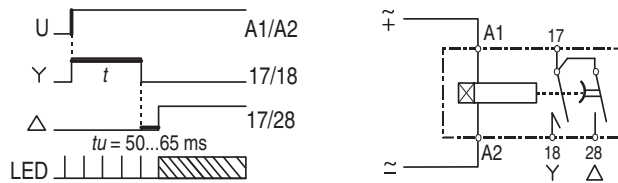

DIN Rail Mounted Timing Relays

Specifications

Specifications

Time Characteristics (according to VDE 0435, Part 2021)

Setting Accuracy	±5% of full scale
Repeatability	±0.2% of the setting values
Tolerance	Voltage: ±0.001%/ΔU Temperature: ±0.025%/°C

Supply

Supply Voltages	24...48V DC and 24...240V AC, 50/60 Hz (multi voltage)
Voltage Tolerance	-20...+20% (DC), -15...+10% (AC)
Power Consumption	0.5 W at 24V DC, 5 VA at 240V AC
Time Energized	100%
Reset Time	50 ms
Voltage Interruption	≤20 ms without reset (supply voltage)
Input Impedance	Relay ON: 3K-13K ohms Relay OFF: 0.7K-4K ohms
Cable Length (Supply Voltage Control)	Max. 250 m (800 ft)

Pulse Control (B1)

Pulse Duration	≥50 ms (AC), ≥30 ms (DC)
Input Voltage	Supply voltage range
Input Current	1 mA
Max. Leakage Current	400 micro Amps
Cable Length	Max. 250 m (800 ft) without parallel load between B1 and A2 Max. 50 m (160 ft) with load (<3 kΩ) between B1 and A2

Outputs

Contact Type	Relay as changeover switch
Dielectric Coil to Contact Withstand Voltage	5000 V
Switching Capacity	Voltage: 440V AC
	Current I _{th} (AC-1): 8 A (5 A for 700-FSQ)
	Power: 2000 VA
	According to IEC 947-5-1:
	3 A/440V AC (inductive load, AC 14) 3 A/250V AC (inductive load, AC 15) 1 A/24V DC (inductive load, DC 13)
Short-Circuit Resistance	According to UL 508:
	1.5 A/250V AC (B300)
	3 A/120V AC (B300)
	10 A gL
Life	Mechanical: 30 million operations
	Electrical operations:
	4 Mil. at 1 A/250V AC, cos φ = 1
	0.2 Mil. at 6 A/250V AC, cos φ = 1
	1.5 Mil. at 1 A/250V AC, cos φ = 0.3
	0.3 Mil. at 3 A/250V AC, cos φ = 0.3
	0.5 Mil. at 6 A/24V DC, resistive
	2 Mil. at 4 A/24V DC, resistive
	2 Mil. at 0.2 A/230V DC, resistive
	1 Mil. at 0.4 A/24V DC, L/R = 20 ms
1 Mil. at 0.2 A/110V DC, L/R = 20 ms	
1 Mil. at 0.1 A/230V DC, L/R = 20 ms	
State Indicator	1 LED, combination signal

General Data

Insulation Characteristics	2 kVAC/50 Hz test voltage according to VDE 0435 and 6 kV 1.2/50 μs surge voltage according to IEC 947-1 between all inputs and outputs
EMC/Interference Immunity	Performance of following requirements: Surge capacity of the supply voltage according to IEC 1000-4-5: 4 kV 1.2/50 μs Burst according to IEC 1000-4-4: 6 kV 6/50 ns ESD discharge according to IEC 1000-4-2: Contact 8 kV, air 8 kV Electromagnetic HF field according to IEC 801-3 and conducted electromagnetic HF signal according to IEC 801-6: Level 3
EMC/Emission	Electromagnetic fields according to EN 55 022: class B
Safe Isolation	According to VDE 106, part 101
Climatic Withstand	56 Cycles (24 hr) at 25...40 °C and 95% relative humidity according to IEC 68-2-30 and IEC 68-2-3
Vibration Resistance	4 g in three axes at 10...500 Hz, test FC according to IEC 68-2-6
Shock Resistance	50 g according to IEC 68-2-27
Protection Class	Enclosure: IP 40 IP 30 (Single-function) Terminal: IP 20 according to IEC 947-1
Weight	100 g
Approval	UL, C-UL
Ambient Temperature	Open: -25...+60 °C Enclosed: -25...+45 °C Storage: -40...+85 °C
Terminals	Screw terminal M3.5 for Number 2 Posidrive, Philips, and slotted screws. Suitable for power screwdriver. Rated tightening torque 8.8 lb.-in. (0.8 N•m, max. 1.2 N•m). Dual-chamber system for terminal cross-sections of 1 x 0.5 mm ² ...2 x 2.5 mm ² (solid) or stranded 2 x 2.5 mm ² (flexible with sleeve), #20...14 AWG. Finger protection according to VDE 0106.
Mounting	Front mounting: For snap-on mounting on 35 mm DIN Rail or screw fixing by adapter and 2 screws (M4 type)
Disposal	Synthetic material without dioxin according to EC/EFTA notification Number 93/0141/D electrical contacts with cadmium
Certifications	cULus Listed (File No. E14840, Guide NKCR/NKCR7), CE Marked
Standards	EN/IEC 60947-1, EN/IEC 60947-5-1, UL 508, CSA 22.2 No. 14

* Performance Data — See this catalog, Important- 3.



Temp. Code T4A
2A 32VDC MAX.

Mounting: Product shall be installed in an enclosure constructed in accordance with the requirements of EN50021.

	<p>Bulletin 700-HNC — Miniature Timing Relay</p> <ul style="list-style-type: none"> • Miniature timer, perfect for converting Bul. 700-HC "Ice Cube" relays into timing relays • 4 operating modes • 4PDT contact output • Timing range from 0.1 s...10 hr • Socket mounted 	<p>Table of Contents</p> <p>Product Selection this page</p> <p>Accessories this page</p> <p>Specifications..... 9-74</p> <p>Approximate Dimensions..... 9-77</p> <p>Standards Compliance and Certifications</p> <p>See Specification table in this section, page 9-75</p>
---	---	---



Product Selection
Bulletin 700-HNC Miniature Timer with Multiple Time Ranges

Model	Timing Mode	Contact Output	Input Voltages	Timing Range	Socket Type	Cat. No.
 <i>Cat. No. 700-HNC</i>	On-Delay One Shot Repeat cycle, OFF-start Repeat cycle, ON-start	4PDT	12V DC	0.1 s...10 min	700-HN103 700-HN128	700-HNC44AZ12
				.1 min...10 hr		700-HNC44BZ12
			24V DC	0.1 s...10 min		700-HNC44AZ24
				0.1 min....10 hr		700-HNC44BZ24
			48V DC	0.1 s...10 min		700-HNC44AZ48
				0.1 min....10 hr		700-HNC44BZ48
			100...110V DC	0.1 s...10 min		700-HNC44AZ11
				0.1 min....10 hr		700-HNC44BZ11
			125V DC	0.1 s...10 min		700-HNC44AZ25
				0.1 min....10 hr		700-HNC44BZ25
			24V AC	0.1 s...10 min		700-HNC44AA24
				0.1 min....10 hr		700-HNC44BA24
			100...120V AC	0.1 s...10 min		700-HNC44AA12
				0.1 min....10 hr		700-HNC44BA12
200...230V AC	0.1 s...10 min	700-HNC44AA23				
	0.1 min....10 hr	700-HNC44BA23				

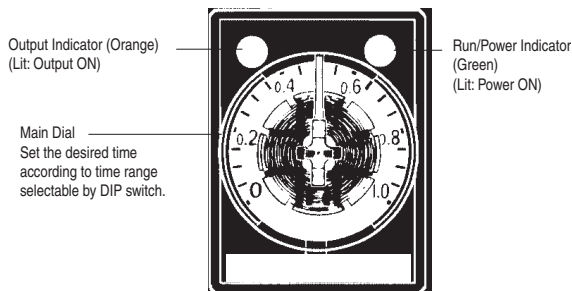

General Timer Functions



Accessories

	Description	Pkg. Quantity	Cat. No.
 <i>Cat. No. 700-HN103</i>	<p>Screw Terminal Socket — Panel or DIN Rail Mounting. Guarded Terminal Construction 14-Blade miniature socket for use with Bulletin 700-HNC timers.</p>	10	700-HN103
 <i>Cat. No. 700-HN128</i>	<p>Screw Terminal Base Sockets — Panel or DIN Rail Mounting. Open Style Construction 14-blade miniature socket for use with Bulletin 700-HNC timers.</p>	10	700-HN128

Bulletin 700-HNC
Plug-in Timing Relays
 Accessories/ Specifications

	Description	Pkg. Quantity	Cat. No.
 Cat. No. 700-HN104	Screw Terminal Socket – Panel or DIN Rail Mounting. Guarded Terminal Construction 14-blade miniature socket for use with Bulletin 700-HNC timers. This socket has coil and contact separation.	10	700-HN104
 Cat. No. 700-HN263	Retainer Clip for Cat. Nos. 700-HN103, -HN104 and -HN128 Sockets with Bulletin 700-HNC Timers. Secures Timer in Socket.	10	700-HN263

Specifications

		Ratings	
Item		700-HNC	
Pilot Duty Rating		NEMA B300	
Pin type		Plug-in	
Operating voltage range		85%...110% of rated supply voltage (12V DC: 90%...110% of rated supply voltage)*	
Reset voltage		10% min. of rated supply voltage‡	
Power consumption	24V AC:	Relay ON: Relay OFF:	1.5 VA (1.1 W) (at 24V AC, 60 Hz) 0.2 VA (0.1 W) (at 24V AC, 60 Hz)
	100...120V AC:	Relay ON: Relay OFF:	1.5 VA (1.3 W) (at 120V AC, 60 Hz) 0.8 VA (0.5 W) (at 120V AC, 60 Hz)
	200...230V AC:	Relay ON: Relay OFF:	1.8 VA (1.5 W) (at 230V AC, 60 Hz) 1.2 VA (0.9 W) (at 230V AC, 60 Hz)
	12V DC:	Relay ON: Relay OFF:	0.9 W (at 12V DC) 0.07 W (at 12V DC)
	24V DC:	Relay ON: Relay OFF:	0.9 W (at 24V DC) 0.07 W (at 24V DC)
	48V DC:	Relay ON: Relay OFF:	1.0 W (at 48V DC) 0.2 W (at 48V DC)
	100...110V DC:	Relay ON: Relay OFF:	1.3 W (at 110V DC) 0.3 W (at 110V DC)
	125V DC:	Relay ON: Relay OFF:	1.3 W (at 125V DC) 0.3 W (at 125V DC)
Control outputs		4PDT: 5 A at 250V AC, resistive load (cosφ = 1)	
Characteristics			
Make	▶ ◀	120V AC	30 A
		240V AC	15 A
Break	◀ ▶	120V AC	3 A
		240V AC	1.5 A
Hp at 120V AC		1/6 Hp	
Hp at 240V AC		1/6 Hp	
Accuracy of operating time		±1% FS max. (1 s range: ±1%±10 ms max.)	
Setting error		±10%±50 ms FS max.	
Reset time		Min. power-opening time: 0.1 s max. (including halfway reset)	
Influence of voltage		±2% FS max.	
Influence of temperature		±2% FS max.	
Insulation resistance		100 mΩ min. (at 500V DC)	
Dielectric strength	2000V AC, 50/60 Hz for 1 min (between current-carrying terminals and exposed non-current-carrying metal parts)*		
	2000V AC, 50/60 Hz for 1 min (between operating power circuit and control output)		
	2000V AC, 50/60 Hz for 1 min (between different pole contacts; 2-pole model)		
	1500V AC, 50/60 Hz for 1 min (between different pole contacts; 4-pole model)		
Vibration resistance		Malfunction:10...55 Hz, 0.5 mm single amplitude	
Shock resistance		Malfunction:100 m/s ² (approx. 10G)	
Ambient temperature		Operating:-10 °C...50 °C (with no icing) Storage:-25 °C...65 °C (with no icing)	
Ambient humidity		Operating:35%...85%	
Life expectancy	Mechanical:10 000 000 operations min. (under no load at 1800 operations/hr)		
	Electrical:4PDT: 200 000 operations min. (3 A at 250V AC, resistive load at 1800 operations/hr)		

* Single-phase, full-wave-rectified power supplies can be used.

‡ When using the 700-HNC continuously in any place where the ambient temperature is in a range of 45 °C...50 °C, supply 90%...110% of the rated supply voltages supply 95%...110% with 12V DC type).

Characteristics, Continued	
Noise immunity	±1.5 kV, square-wave noise by noise simulator (pulse width: 100 ns/1 μs, 1-ns rise)
Static immunity	Destruction:8 kV Malfunction:4 kV
Enclosure rating	IP40
Weight	Approx. 50 g
EMC	Emission Enclosure:EN55011 Group 1 class A
	Emission AC Mains:EN55011 Group 1 class A
	Immunity ESD:EN61000-4-2:4 kV contact discharge (level 2) 8 kV air discharge (level 3)
	Immunity RF-interference:ENV50140:10 V/m (amplitude modulated, 80 MHz to 1 GHz) (level 3) 10 V/m (pulse modulated, 900 MHz)
	Immunity Conducted Disturbance:ENV50141:10 V (0.15...80 MHz) (level 3) Immunity Burst:EN61000-4-4:2 kV power-line (level 3) 2 kV I/O signal-line (level 4)
Standards	UL 508, CSA 22.2 No. 14, EN/IEC 61812-1
Certifications	cURus Recognized (File No. E14843, Guide NRNT2/NRNT8), CSA Certified (File 224268), CE Marked, C-Tick Marked

Timing Charts

Note :t:Set time
 Rt:Reset time

Operating Mode	Timing Charts / Wiring Diagram
<p>ON-Delay</p>	
<p>One Shot</p>	
<p>Repeat Cycle OFF-Start</p>	
<p>Repeat Cycle ON-Start</p>	

Bulletin 700-HNC
Plug-in Timing Relays
 DIP Switch Settings

Pulse Operation

A pulse output for a certain period can be obtained with a random external input signal. Use the 700-HNC timing relay in interval mode as shown in the following timing charts.

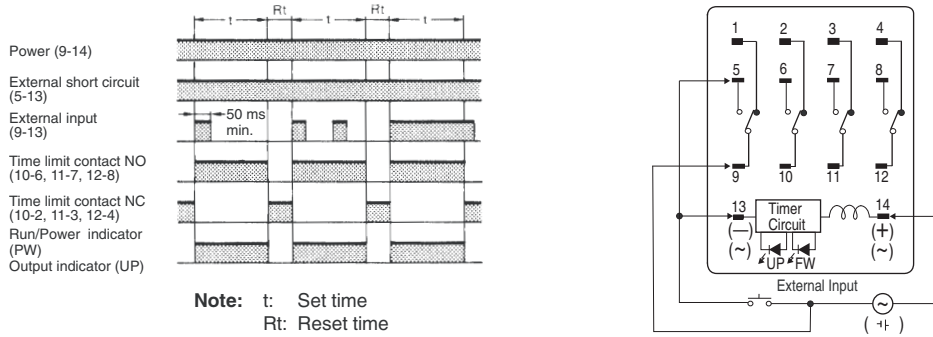

DIP Switch Settings
Time Ranges

Cat. No.	Time Range	Time Setting Range	Setting	Factory-Set
700-HNC44AZ12 700-HNC44AZ24 700-HNC44AZ48 700-HNC44AZ11 700-HNC44AZ25 700-HNC44AA24 700-HNC44AA12 700-HNC44AA23	1 s	0.1 s...1 s		Yes
	10 s	1 s...10 s		No
	1 min	0.1 s...1 min		No
	10 min	1...10 min		No
700-HNC44BZ12 700-HNC44BZ24 700-HNC44BZ48 700-HNC44BZ11 700-HNC44BZ25 700-HNC44BA24 700-HNC44BA12 700-HNC44BA23	1 min	0.1...1 min		Yes
	10 min	1...10 min		No
	1 hr	0.1...1 hr		No
	1 hr	1...10 hr		No

Note: The top two DIP switch pins are used to select the time ranges.

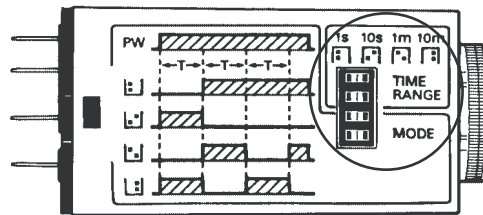

9

Operating Mode	Setting	Factory-set
ON-delay		Yes
One Shot		No
Repeat Cycle OFF-start		No
Repeat Cycle ON-start		No

Note: The bottom two DIP switch pins are used to select the time ranges.

Approximate Dimensions

Approximate Dimensions are shown in millimeters (inches) where not specified. Approximate Dimensions are not intended to be used for manufacturing purposes.

Timers

Front Mounting

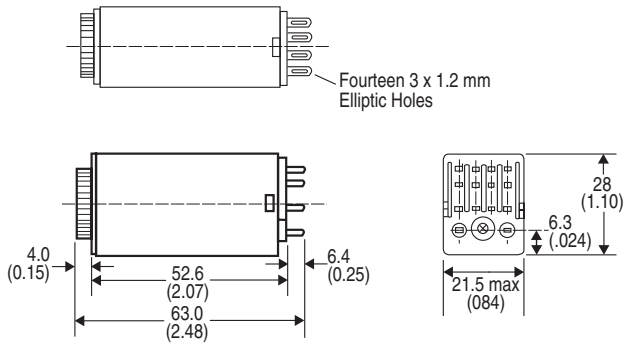

Cat.No. 700-HNC

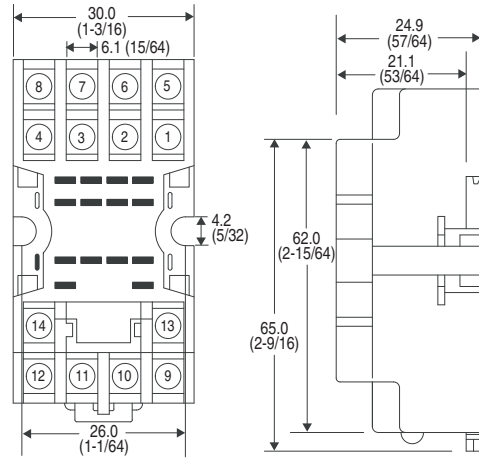

Cat. No. 700-HN128*
 Wire Size: 2 x 1.5 mm² (#2-16 AWG...#1-20 AWG)
 (Either Solid or Stranded)
 Strip Length: 9 mm (3/8 in.) - Torque: 0.8 N•m (7 lb•in)

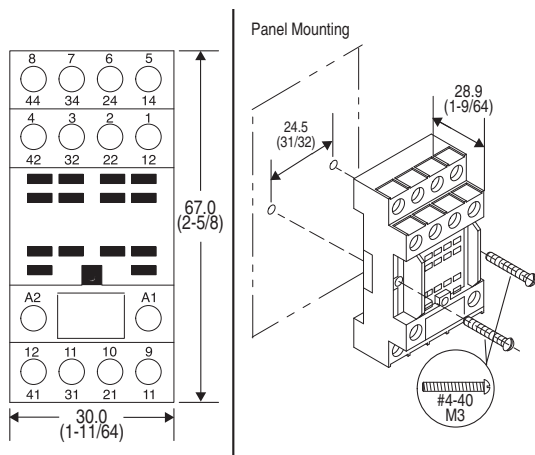

Cat. No. 700-HN103

Single wire: 0.2...2.5 mm² (#24 AWG...14 AWG)
 Double wire: 2 x 0.2 mm²...2 x 1.5 mm² (2 x 24 AWG...2 x 16 AWG)
 Wire type: solid or stranded, copper only
 Strip length: 8 mm (5/16 in.), Torque: 0.5 N•m (4.4 lb•in)

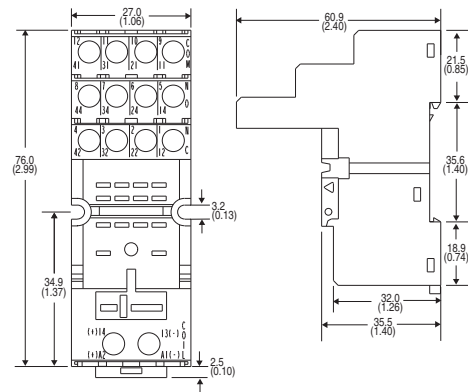

Cat. No. HN-104

Single Wire: 0.2...2.5 mm² (#24 AWG...14 AWG)
 Double Wire: 2 x 0.2 mm²...2 x 2.5 mm² (2 x 24 AWG...2 x 14 AWG)
 Wire Type: solid or stranded, copper only
 Strip Length: 7 mm (9/32 in.), Torque: 0.5 N•m (4.4 lb•in)

* Total height of 700-HN128 + 700-HNC is 82.5 mm.

Plug-in Timing Relays

Product Overview/Product Selection



Bulletin 700-HNK — Ultra-Slim Timing Relay

- The ultra-slim timing relay is the smallest relay available
- It is perfect for converting Bulletin 700-HK relays into a timing relay
- SPDT and DPST-NO contact output
- Socket-mounted
- Timing range From 0.1 s...10 hr

Table of Contents

Product Selection this page
 Accessories..... this page
 Specifications..... 9-79
 Approximate Dimensions..... 9-83

Standards Compliance and Certifications

See Specification table in this section, page 9-79

Product Selection

Bulletin 700-HNK Miniature Timer with Multiple Time Ranges

	Timing Mode	Socket Type	Contact Output	Timing Range	Input Voltage	Cat. No.
<p>Cat. No. 700-HNK SPDT, DPST-NO</p>	On-Delay One Shot Repeat Cycle, OFF-start Repeat Cycle, ON-start	700-HN121	SPDT*	0.1 s...10 min	12V DC	700-HNK41AZ12
					24V DC	700-HNK41AZ24
				24V AC	700-HNK41AA24	
		0.1 min...10 hr	12V DC	700-HNK41BZ12		
			24V DC	700-HNK41BZ24		
			24V AC	700-HNK41BA24		
	700-HN122	DPST-NO*	0.1 s...10 min	12V DC	700-HNK42AZ12	
				24V DC	700-HNK42AZ24	
			0.1 min...10 hr	12V DC	700-HNK42BZ12	
				24V DC	700-HNK42BZ24	
			24V AC	700-HNK42BA24		

* 5-blade terminal type only.

* 8-blade terminal type only.

General Timer Functions

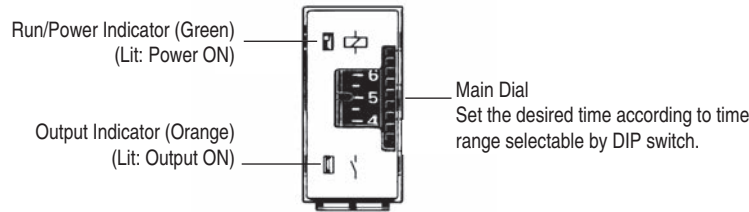

Accessories

	Description	Pkg. Quantity	Cat. No.
<p>Cat. No. 700-HN121</p>	Screw Terminal Socket — Panel or DIN Rail Mounting 5-blade miniature socket. For use with 1-pole type 700-HNK41 timers. Socket includes a retainer clip.	10	700-HN121
<p>Cat. No. 700-HN122</p>	Screw Terminal Socket — Panel or DIN Rail Mounting 8-blade miniature socket for use with 2-pole, Bulletin 700-HNK42 timers. This socket includes a retainer clip.	10	700-HN122

Timing Relay, Socket, Retainer Clip Reference Chart

Timer Type	Socket Cat. No.	Retainer Clip Cat. No.
700-HNK	700-HN121	Provided
	700-HN122	Provided

Specifications

Item		Ratings
Pilot Duty Rating		NEMA B300
Rated Supply Voltage		24V AC; 12, 24V DC
Pin Type		Plug-in
Operating Mode		ON-delay, One Shot, Repeat Cycle OFF start, or Repeat Cycle ON start selectable with DIP switch.
Operating Voltage Range		85%...110% of rated supply voltage (12 VDC: 90%...110% of rated supply voltage)*
Power Consumption		24V AC:Relay ON:approx. 0.8 VA (at 24 VAC, 60 Hz) Relay OFF:0.5 VA (at 24V AC, 60 Hz) 12V DC:Relay ON:approx. 0.4 W (at 12V DC) Relay OFF:0.1 W (at 12V DC) 24V DC:Relay ON:approx. 0.5 W (at 24V DC) Relay OFF:0.2 W (at 24V DC)
Control Outputs		5 A at 250V AC, resistive load ($\cos\phi = 1$) The minimum applicable load is 10 mA at 5 VDC (P reference value).
Characteristics		
▶ ◀	120V AC	30 A
Make	240V AC	15 A
◀ ▶	120V AC	3 A
Break	240V AC	1.5 A
Hp at 240V AC		1/6 Hp
Accuracy of Operating Time		±1% FS max. (1 s range: +1%±10 ms max.)
Setting Error		±15%+50 ms FS max.
Reset Time		Min. power-opening time: 12, 24V DC: 0.1 s max. (including halfway reset) 24V AC: 0.5 s max. (including halfway reset)
Influence of Voltage		±2% FS max.
Influence of Temperature		±2% FS max.
Insulation Resistance		100 mΩ min. (at 500V DC)
Dielectric Strength		2000V AC, 50/60 Hz for 1 min (between operating circuit and control output, or contacts of different poles) 1000V AC, 50/60 Hz for 1 min (between non-continuous contacts)
Vibration Resistance		Malfunction:10...55 Hz, 0.5 mm single amplitude
Shock Resistance		Malfunction:100 m/s ² (approx. 10G)
Ambient Temperature		Operating:-10 °C...50 °C (with no icing) Storage:-25 °C...65 °C (with no icing)
Ambient Humidity		Operating:35...85%
Life Expectancy		Mechanical:10 000 000 operations min. (under no load at 1800 operations/hr) Electrical:100 000 operations min. (3 A at 250V AC, resistive load at 1800 operations/hr)
Impulse Withstand Voltage		Between power terminals: 1 kV
Noise Immunity		±1.5 kV, square-wave noise by noise simulator (pulse width: 100 ns/1 μs, 1-ns rise)
Static Immunity		Destruction:8 kV Malfunction:4 kV
Enclosure Rating		IP20
Weight		Approx. 18 g
EMC		Emission Enclosure:EN55011 Group 1 class A Emission AC Mains:EN55011 Group 1 class A Immunity ESD:EN61000-4-2:4 kV contact discharge (level 2) 8 kV air discharge (level 3) Immunity RF-interference:ENV50140:10 V/m (amplitude modulated, 80 MHz...1GHz) (level 3) 10 V/m (pulse modulated, 900 MHz) Immunity Conducted Disturbance:ENV50141:10 V (0.15...80 MHz) (level 3) Immunity Burst:EN61000-4-4:2 kV power-line (level 3) 2 kV I/O signal-line (level 4)
Standards		UL508, CSA C22.2 No. 14, EN/IEC 60947-5-1, EN/IEC 61812-1
Certifications		cURus Recognized Component (File No. E14843, Guide NRNTZ/NRNT8), CE Marked, C-Tick Marked

* When using 700-HNK timer in any place where the ambient temperature is more than 50 °C, supply 90...110% of the rated voltages (12V DC: 95...11 % of the rated voltage).

Note:

t: Set time

Rt: Reset time

Bulletin 700-HNK
Plug-in Timing Relays
 Timing Chart

Operating Mode	Timing Chart	
	700-HNK41...	700-HNK42...
<p>ON-Delay</p>	<p>Power (1-5)</p> <p>Time limit contact NC (4-2)</p> <p>Time limit contact NO (4-3)</p> <p>Run/ Power Indicator (PW)</p> <p>Output Indicator (OUT)</p>	<p>Power (1-8)</p> <p>Time limit contact NO 4-3, 5-6</p> <p>Run/Power indicator (PW)</p> <p>Output indicator (OUT)</p>
<p>One shot</p>	<p>Power (1-5)</p> <p>Time limit contact NC (4-2)</p> <p>Time limit contact NO (4-3)</p> <p>Run/ Power Indicator (PW)</p> <p>Output Indicator (OUT)</p>	<p>Power (1-8)</p> <p>Time limit contact NO (4-3, 5-6)</p> <p>Run/Power indicator (PW)</p> <p>Output indicator (OUT)</p>
<p>Repeat Cycle OFF-Start</p>	<p>Power (1-5)</p> <p>Time limit contact NC (4-2)</p> <p>Time limit contact NO (4-3)</p> <p>Run/ Power Indicator (PW)</p> <p>Output Indicator (OUT)</p>	<p>Power (1-8)</p> <p>Time limit contact NO (4-3, 5-6)</p> <p>Run/Power indicator (PW)</p> <p>Output indicator (OUT)</p>
<p>Repeat Cycle ON-Start</p>	<p>Power (1-5)</p> <p>Time limit contact NC (4-2)</p> <p>Time limit contact NO (4-3)</p> <p>Run/ Power Indicator (PW)</p> <p>Output Indicator (OUT)</p>	<p>Power (1-8)</p> <p>Time limit contact NO (4-3, 5-6)</p> <p>Run/Power indicator (PW)</p> <p>Output indicator (OUT)</p>

Wiring Diagrams

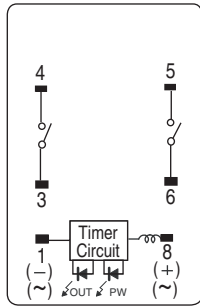

Cat. No. 700-HNK42...

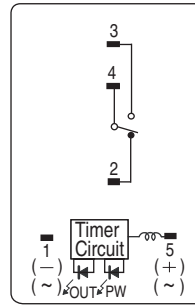

Cat. No. 700-HNK41...

A pulse output for a certain period can be obtained with a random external input signal. Use the 700-HNK in interval mode as shown in the following timing chart.

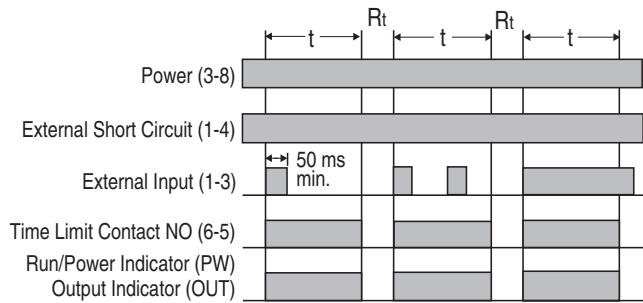
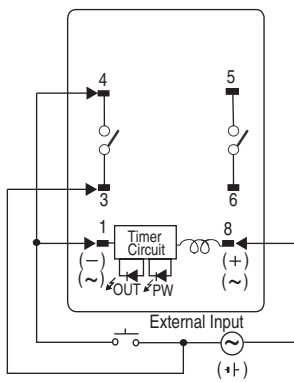

Note: t: Set time
 Rt: Reset time

Mode	Terminals
Pulse Operation	Power supply between 3 and 8 Short-circuit between 4 and 1 Input signal between 3 and 1
Operating mode; One shot and all other modes	Power supply between 1 and 8

Bulletin 700-HNK
Plug-in Timing Relays
 Timing Ranges

Time Ranges

Cat. No.	Time Range	Time Setting Range	Setting	Factory-Set
700-HNK41AZ12 700-HNK41AZ24 700-HNK41AA24 700-HNK42AZ12 700-HNK42AZ24 700-HNK42AA24	1 s	0.1...1 s		Yes
	10 s	1...10 s		No
	1 min	0.1 s...1 min		No
	10 min	1...10 min		No
700-HNK41BZ12 700-HNK41BZ24 700-HNK41BA24 700-HNK42BZ12 700-HNK42BZ24 700-HNK42BA24	1 min	0.1...1 min		Yes
	10 min	1...10 min		No
	1 hr	0.1...1 hr		No
	10 hr	1...10 hr		No

Note: The left two DIP switch pins are used to select the time ranges.

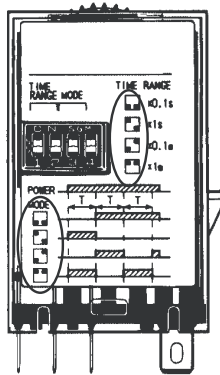

Operating Modes

Operating Mode	Setting	Factory-set
On-delay		Yes
One Shot		No
Repeat Cycle Off-start		No
Repeat Cycle On-start		No

Note: The right two DIP switch pins are used to select the operating modes.

9

Approximate Dimensions

Approximate Dimensions are shown in millimeters (inches). Approximate Dimensions are not intended to be used for manufacturing purposes.

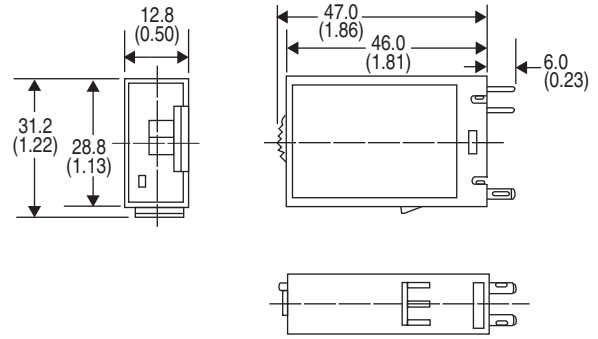
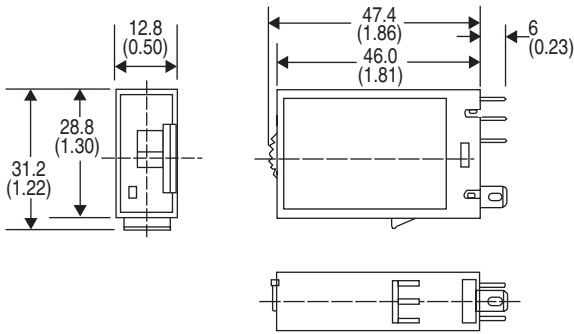

Bulletin 700-HNK41 SPDT Contact
 Approximate Dimensions

Bulletin 700-HNK42 DPST-NO Contact
 Approximate Dimensions

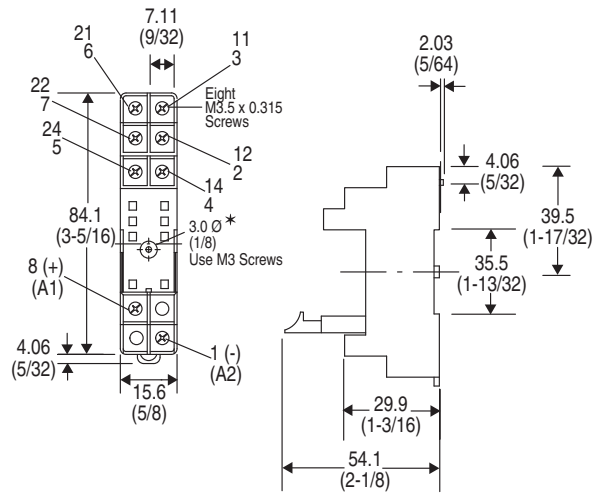
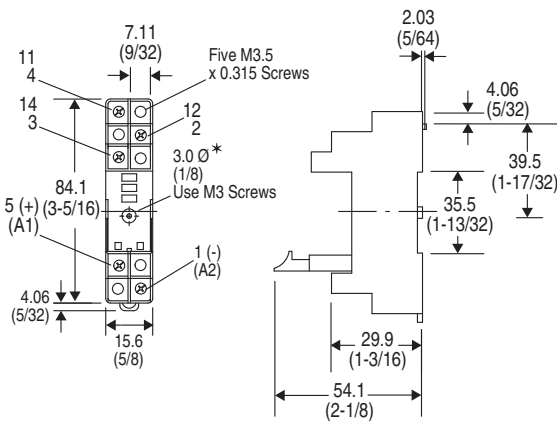

Cat No. 700-HN121

Wire Size: 2 x 2.5 mm²
Single Wire – Up to #12 AWG
Double Wire – 2 x 2.5 mm² (#2–14 AWG... #2–20 AWG)
(Either Solid or Stranded)
Strip Length: 9 mm (3/8 in.) – Torque: 0.8 N•m (7 lb•in)
Total height: 700-HN121 + 700-HNK41 is 78.0 mm.

* Holes required for mounting [3 mm (1/8 in.) diameter].

Cat No. 700-HN122

Wire Size: 2 x 2.5 mm²
Single Wire – Up to #12 AWG
Double Wire – 2 x 2.5 mm² (#2–14 AWG... #2–20 AWG)
(Either Solid or Stranded)
Strip Length: 9 mm (3/8 in.) – Torque: 0.8 N•m (7 lb•in)
Total height: 700-HN122 + 700-HNK42 is 78.0 mm.

* Holes required for mounting [3 mm (1/8 in.) diameter].



Bulletin 700-HR — Dial Timing Relay

- Socket- or panel-mounted
- 5 A contact ratings or transistor outputs
- Single- or Multi-Function
- Timing range from 0.05 s...300 hr
- Multi-voltage inputs

Table of Contents

Product Selection this page
 Accessories..... 9-87
 Specifications..... 9-89
 Approximate
 Dimensions..... 9-95
**Standards Compliance
 and Certifications**
 See Specification table in this
 section, page 9-89

Product Selection

Bulletin 700 Multi-Function Timing Relays with Trigger and Reset Switch Options

- Socket or Panel Mounted
- Timing Range From 0.05 s...300 hr
- 11-pin base for socket cat. nos. 700-HN101, -HN126, -HN129
- Trigger: Power on or optional trigger signal
- Reset: Power off or optional reset signal

Timing Mode	Supply Voltage	Trigger Options	Reset Options	Outputs	Cat. No.
On-Delay (A) OFF-Delay (D) One Shot (E) Repeat cycle OFF-Start (B) Repeat Cycle ON-Start (B2) Signal ON/OFF-delay (C)	24...48V AC 12...48V DC	1. Power On 2. Start Signal - contact closure (zero volts) - NPN transistor 3. Gate Signal (pause)	1. Power Off 2. Reset Signal - contact closure (zero volts) - NPN transistor	DPDT	700-HR52TU24
				Transistor	* 700-HRT6TTU24
	100...240V AC 100...125V DC	1. Power On 2. Start Signal - contact closure (voltage) - NPN transistor - PNP transistor	Power Off	DPDT	700-HRV52TU24
		1. Power On 2. Start Signal - contact closure (zero volts) 3. Gate Signal (pause)	1. Power Off 2. Reset Signal - contact closure (zero volts)	DPDT	700-HR52TA17
		1. Power On 2. Start Signal - contact closure (voltage)	Power Off	DPDT	* 700-HRV52TA17

Bulletin 700 Multi-Function Timing Relays with Power On Trigger

- Socket or Panel Mounted
- Timing Range From 0.05 s...300 hr
- 8-pin base for socket cat. nos. 700-HN100, -HN125, -HN108
- Trigger: Power on
- Reset: Power off

Timing Mode	Supply Voltage	Trigger Options	Reset Options	Outputs	Cat. No.
ON-Delay (A) One Shot (E) Repeat Cycle ON-Start (B2) Delayed One Shot (J)	24...48V AC 12...48V DC	Power On	Power Off	DPDT	700-HRS42TU24
				Transistor	* 700-HRT4TTU24
	24...48V AC/DC	Power On	Power Off	SPDT Timed + Instantaneous Contact	* 700-HRP42TU24
				SPDT Timed + Instantaneous Contact	700-HRP42TA17
100...240V AC 100...125V DC	Power On	Power Off	DPDT	700-HRS42TA17	

* Voltage input connection to high signal instead of OV signal.

Bulletin 700 ON-Delay Timing Relays

- Socket or Panel Mounted
- Timing Range From 0.05 s...300 h
- 8-pin base for socket cat. nos. 700-HN100, -HN125, -HN108
- Trigger: Power on
- Reset: Power off

Timing Mode	Supply Voltage	Trigger Options	Reset Options	Outputs	Cat. No.
ON-Delay (A)	24...48V AC/DC	Power On	Power Off	SPDT Timed + Instantaneous Contact	700-HRC12TU24
	24...48V AC 12...48V DC			DPDT	700-HRM12TU24
		100...240V AC	Power On	Power Off	DPDT
	SPDT Timed + Instantaneous Contact				700-HRC12TA17

Timing mode description

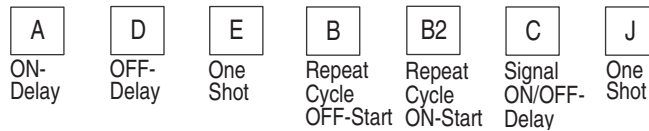

Bulletin 700-HRF Repeat Cycle Timing Relays

- Socket or Panel Mounted
- Independently adjustable on- and off-time
- 8-Pin base for socket cat. nos. 700-HN100, -HN125, and -HN108
- DPDT contact outputs
- Trigger: Power on
- Reset: Power off



Cat. No. Explanation

700 – HRF 7 2 D Z12
a b c d e

a

Timer Type	
Code	Description
HRF	Repeat cycle with adjustable ON/OFF times

c

Contact Output	
Code	Description
2	DPDT

e

Supply Voltage	
Code	Description
A18	100...240V AC, 50/60 Hz
U25	24V AC, 50/60 Hz; 24V DC
Z12	12V DC
Z45	48...125V DC

b







Function	
Code	Description
7	Repeat cycle with OFF start
8	Repeat cycle with ON start

d



Time Range	
Code	Description
D	0.05 s...30 hr



Accessories

	Description	Pkg. Qty.	Cat. No.
 Cat. No. 700-HN100	Screw Terminal Tube Base Socket — Panel or DIN Rail Mounting; Guarded Terminal Construction. 8-Pin for use with Bulletin 700-HR and -HX timing relays.	10	700-HN100
 Cat. No. 700-HN125	Screw Terminal Tube Base Socket — Panel or DIN Rail Mounting; Open Style Construction. 8-Pin for use with Bulletin 700-HR and -HX timing relays. No retainer clip required.	10	700-HN125
 Cat. No. 700-HN101	Screw Terminal Tube Base Sockets — Panel or DIN Rail Mounting; Guarded Terminal Construction. 11-pin for use with 3PDT 700-HA relays.	10	700-HN101
 Cat. No. 700-HN126	Screw Terminal Tube Base Sockets — Panel or DIN Rail Mounting; Open Style Terminal Construction. 11-pin for use with 3PDT 700-HA relays. No retainer clip required.	10	700-HN126
 Cat. No. 199-DR1	DIN (#3) symmetrical hat rail 35 x 7.5 x 1 m	10	199-DR1
 Cat. No. 700-HN108	Specialty Socket 8-pin backwired socket with solder terminals for use with 700-HR timing relays. Order 10 or multiples of 10.	10	700-HN108
 Cat. No. 700-HN129	Specialty Socket 11-pin back-wired socket with solder terminals for use with Bulletin 700-HR timing relays.	10	700-HN129

Bulletin 700-HR
Plug-in Timing Relays
 Accessories

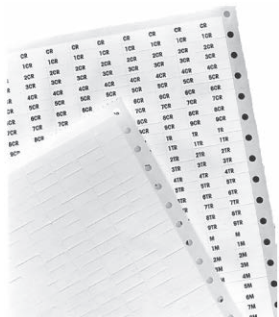
	Description	Pkg. Quantity	Cat. No.
 Cat. No. 700-HN130	Frame Adapter For flush or door mounting of all Bulletin 700-HR and -HX timers.	1	700-HN130
 Sample Retainer Clips	Retainer Clip for Cat. Nos. 700-HN100 and -HN101 Sockets with all 700-HR Timing Relays Secures timer in socket. Note: Not required for installation	10	700-HN131
 Cat. No. 700-HN132	Protective Cover Helps prevent tampering of timing and mode settings. Provides a degree of protection against water and dirt from entering the front of the relay. For use with all Bulletin 700-HRs and -HX timing relays.	1	700-HN132
	Pre-Printed Identification Tags — contains 10 sheets of pre-printed and blank tags. Each sheet contains 13 sets of the markings CR...9CR, TR...9TR, M...9M, F, R, 1S, and 117 blank tags. Tags are peel-off with sticky backing for easy placement on relays.	10	700-N40
	Blank Identification Tags — contains 10 sheets of blank identification tags for customer specialized printing. Each sheet contains 546 blank tags. Tags are peel-off with sticky backing for easy placement on relays.	10	700-N41

Bulletin 700-HR Multi-function, Multi-Range Dial Timing Relay, Socket, Retainer Clip Reference Chart

Timer Type	Socket Cat. No.	Retainer Clip Cat. No.
700-HR52, -HRT6, -HRV, -HRQR	⊛ 700-HN101	700-HN131
	⊛ 700-HN126	Not Required*
	⊛ 700-HN129	Not Applicable
700-HRS, -HRT4, -HRP, -HRC, -HRM, -HRF, -HRY, -HRQN	‡ 700-HN100	700-HN131(See note above)
	‡ 700-HN108	Not Applicable
	‡ 700-HN125	Not Required*

* Design of these sockets holds the timing relays securely and does not require retainer clips.

⊛ 11 pins.

‡ 8 + pins.

	700-HR, -HRS, -HRV	700-HRP	700-HRC	700-HRM	700-HRF	700-HRY	700-HRQ	700-HRT (Transistor Outputs)	
Electrical Ratings									
Pilot Duty Rating	NEMA B300							—	
Thermal Current (I_{th})	5 A							100 mA @ 30V DC max.	
Make	▶] [◀	120V AC	30 A			—			
	▶] [◀	240V AC	15 A			—			
Break	◀] [▶	120V AC	3 A			—			
	◀] [▶	240V AC	1.5 A			—			
Hp at 120V	1/6 Hp (0.12 kW)	1/4 Hp (0.18 kW)		1/6 Hp (0.12 kW)		1/4 Hp (0.18 kW)	1/6 Hp (0.12 kW)	—	
Hp at 240V	1/3 Hp (0.25 kW)								
Resistive Load	5 A at 250V AC/30V DC								
Inductive Load	AC-15 @ 250V AC, 3 A/DC-13 @ 30V DC, 0.5 A								
Accuracy of Operating Time	±0.2 % FS max. (±0.2 % ±10 ms max. in a range of 1.2 s)								
Setting Error	±5 % FS ±50 ms (The value is ±5 % FS +100 ms to -0 ms max. when the C or D mode signal of the 700-HRVs are OFF.)								
Influence of Voltage	±0.2 % FS max. (±0.2 % ±10 ms max. in a range of 1.2 s)								
Influence of Temperature	±1 % FS max. (±1 % ±10 ms max. in a range of 1.2 s)								
Permissible Leakage Current	—								
Power Consumption	-HR52, -HRS	-HRV	-HRP, -HRC	-HRM	-HRF	-HRY	-HRQ	-HRT	
240V AC, Output ON	2.1 VA	2.5 VA	2.0 VA	2.1 VA	10 VA	12 VA	0.4 VA	—	
240V AC, Output OFF	1.3 VA	1.8 VA	2.0 VA	1.3 VA	10 VA	12 VA	0.4 VA	—	
24V DC, Output ON	0.8 W	0.9 W	0.9 W	0.8 W	1.0 W	—	0.2 W	0.3 W	
24V DC, Output OFF	0.2 W	0.3 W	0.9 W	0.2 W	1.0 W	—	0.2 W	0.2 W	
Design Specifications									
Dielectric Strength	2000V AC (1000V AC for 700-HRT), 50/60 Hz for 1 min (contact to frame) 2000V AC (1000V AC for 700-HRT), 50/60 Hz for 1 min (between control output terminals and operating circuit) 2000V AC, 50/60 Hz for 1 min (pole-to-pole) 1000V AC, 50/60 Hz for 1 min (between contacts not located next to each other) 2000V AC, 50/60 Hz for 1 min (contact to coil)								
Mechanical									
Vibration Resistance	Malfunction: 10...55 Hz with 0.5 mm double amplitude each in three directions for ten minutes each								
Shock Resistance	Malfunction: 100 m/s ² (10 G)				98 m/s ² (10 G)	294 m/s ² (10 G)	98 m/s ² (10 G)	100 m/s ² (10 G)	
Environmental									
Noise Immunity	±1.5 kV for ±600V DC				±400V for 12V DC		±1kV for 48V DC	±1.5 kV for ±600V DC	
Static Immunity	Malfunction: 8 kV								
Ambient Temperature	Operating: -10...55 °C (with no icing) Storage: -25...65 °C (with no icing)								
Ambient Humidity	Operating: 35...85 %								
Construction									
Life Expectancy (Min. Operations)	Mechanical: 20 000 000. (under no load at 1800 operations/h) Electrical: 100 000 (5 A at 250V AC, resistive load at 1800 operations/h)					Mech: 10 ⁷ Electrical: 10 ⁴			
EMC	(EMI) EN50081-2 Emission Enclosure: EN55011 Group 1 class A Emission AC Mains: EN55011 Group 1 class A (EMS) EN50082-2 Immunity ESD: EN61000-4-2: 4 kV contact discharge (level 2) 8 kV air discharge (level 3) Immunity RF-interference from AM Radio Waves: ENV50140: 10 V/m (80 MHz...1 GHz) (level 3) Immunity RF-interference from Pulse-modulated Radio Waves: ENV50204: 10 V/m (900 ±5 MHz) (level 3) Immunity Conducted Disturbance: ENV50141: 10 V (0.15...80 MHz) (level 3) Immunity Burst: EN61000-4-4: 2 kV power-line (level 3) Immunity Surge: EN61000-4-52 kV I/O signal-line (level 4) 1 kV line to line 2 kV line to ground (level 3)								
Degree of Protection	IP40 (panel surface)								
Weight	Approx. 90 g								
Certifications	CSA Certified (File No. 70751), UL Recognized (File No. E14843 Guide No. NRNT2), CE Marked, C-Tick Marked								
Standards	UL 508, CSA C22.2 No. 14, EN 61812-1, EN 61000-6-2, -6-4								

Bulletin 700-HR
Plug-in Timing Relays
 Timing Module Examples

Timer Functions

700-HR Multifunction Timer

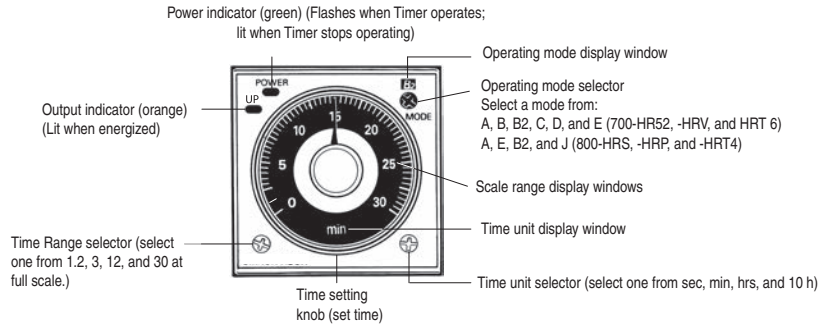

700-HRC -HRM On-Delay Timer

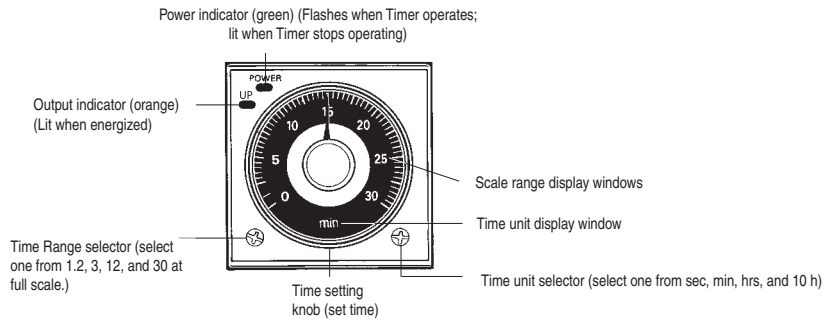

700-HRF Twin Timer

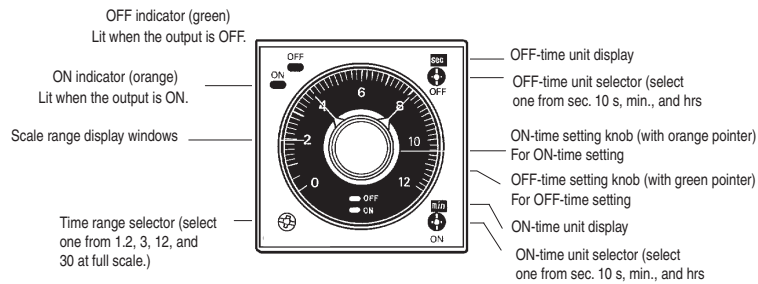

700-HRY Star-Delta Timer

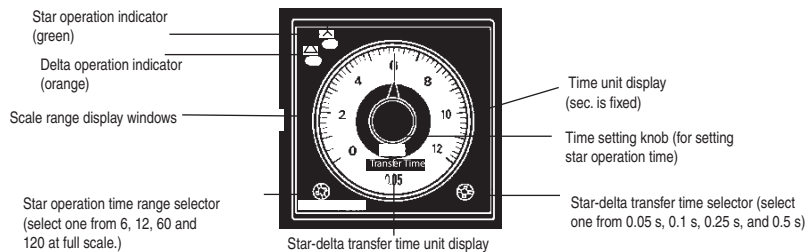

700-HRQ True Off-Delay Timer

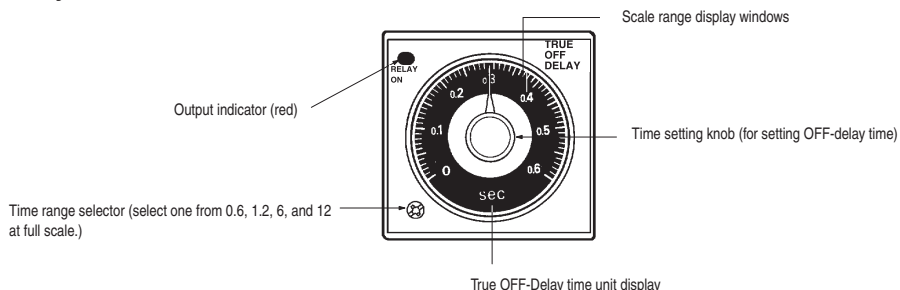

Specifications for Start, Gate, Reset Signal (Cat. Nos. 700-HR52, -HRT6, -HRV, -HRQR)

Start, Reset, and Gate signals are typically contact closures or signals from a solid-state sensor.

(R) Reset Signal

The reset signal is not required for normal operation. Reset can be accomplished by removing power from the timing relay. To reset the timer without removing power, a signal must be applied which resets the timing cycle and returns the output contacts to their shelf state. The reset signal will override both the start signal and gate signal. The reset signal can be either momentary or maintained.

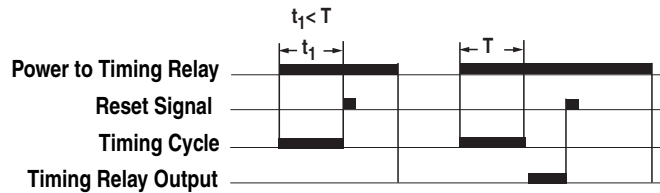

(G) Gate Signal

The gate signal is not required for normal operation. The gate signal provides a pause or retentive timing function. When the gate signal is applied the timing cycle is momentarily interrupted. When the signal is removed, the timing cycle resumes timing at the point the cycle was interrupted and will continue timing until the time delay is completed or the gate signal is re-applied.

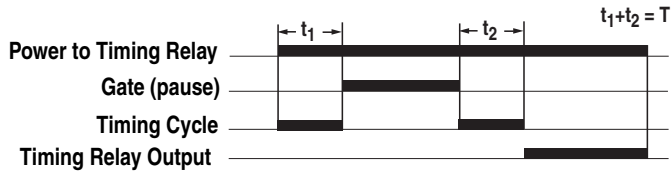

Contact Signal — Cat. Nos. 700-HR52, -HRT6, -HRQR

Contact closure provides signal to timer. A low energy signal is generated by the 700-HR timing relay. For optimum reliability, use contacts designed for low energy switching (5V, 1 mA) (Bul. 800F-X_V, 800T-X_V). No external voltage should be connected to the contact signal.

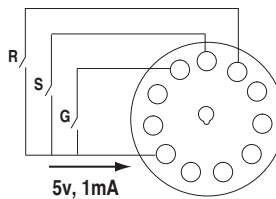

Contact Signal — Cat. No. 700-HRV

For use in applications where it is not possible to use contacts designed for low energy switching. Contact closure provides signal to timer. A signal is generated by the 700-HR timing relay, and is the same potential as the supply voltage of the timing relay. No external voltage should be connected to contact signal. 700-HRV52TU24 supply voltage: 24...48V AC, 12...48V DC / 700-HRV52TA17 supply voltage: 100...240V AC, 100...125V DC.

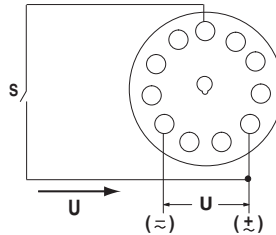

Solid-State Signal — Cat. Nos. 700-HR52, -HRT6

Timing relay is suitable for use with a 3-wire NPN 12...24V DC sensor. Supply voltage potential of sensor must be the same as the supply voltage potential of the timing relay. Permissible off-state leakage current from sensor: 0.01 mA max.

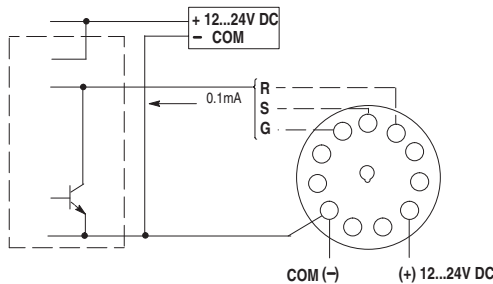

Solid-State Signal — Cat. No. 700-HRV

Timing relay is suitable for use with a 3-wire NPN or PNP 12...24V DC sensor. Supply voltage potential of sensor must be the same as the supply voltage potential of the timing relay. Permissible off-state leakage current from sensor: 0.01 mA max.

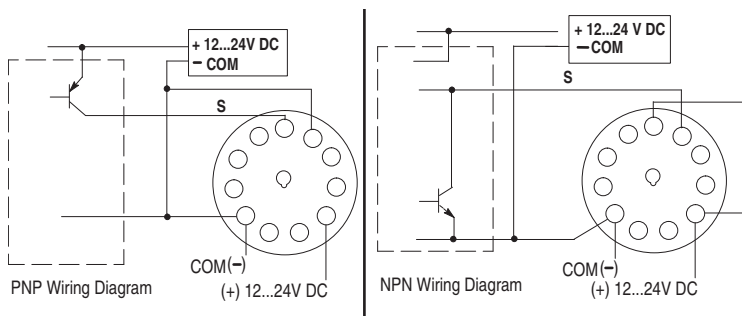

Signal Specifications					
Circuit Impedance	Circuit impedance can be used to calculate the maximum wiring distance from the signal switch to the timing relay, for example. Permissible signal-ON impedance: 1 kΩ max. Permissible signal-OFF impedance: 100 kΩ min.				
Power-OFF Reset	Min. power-off time: 0.1 s, Reset Voltage: 10% max. of rated voltage				
Signal Duration	Min. pulse width: 0.05 s				
Signal Options		700-HR52	700-HRT6	700-HRV5	700-HRQR
	Start	X	X	X	NA
	Reset	X	X	NA	X
	Gate	X	X	NA	NA

Nomenclature
Timing Charts

Mode A — ON-Delay

- Needs continuous input power applied.
- Timing is initiated by the leading edge of the start signal.
- Contacts change state after timing is complete.
- Additional start signals during timing don't reset timing or contacts.
- When the input power is removed contacts return to shelf state.

Basic Operation



Mode B — Repeat Cycle, Off Start

- Need continuous input power applied.
- Timing is initiated by the leading edge of the start signal. Additional start signals during timing do not reset timing or contacts.
- For the first time period the contacts remain in their shelf state. When that time period is complete contacts change state for the same time period (time on = time off).
- This cycle repeats itself until input power is removed or reset signal is applied. When the input power is removed or reset signal is applied contacts return to the shelf state.

Basic Operation



- Need continuous input power applied.
- Timing is initiated by the leading edge of the start signal. Additional start signals during timing do not reset timing or contacts.
- For the first time period the contacts change state. When that time period is complete contacts return to the shelf state for the same time period (time on = time off).
- This cycle repeats itself until input power is removed or reset signal is applied. When the input power is removed or reset signal is applied contacts return to the shelf state.

Basic Operation



Mode C — Watchdog monitor (Trigger = Signal On/Off)

- Need continuous input power applied.
- Contacts change state immediately when start signal is applied or when start signal is removed (only if timing cycle was complete).
- Timing is initiated at the leading edge of the start signal. After the first timing cycle is complete, timing is initiated by the trailing edge of the start signal.
- At the end of the time period contacts return to the shelf state.
- Relay timing is reset when additional start signals are applied while the relay is timing. Contacts remain in energized state.
- When the input power is removed contacts return to the shelf state.

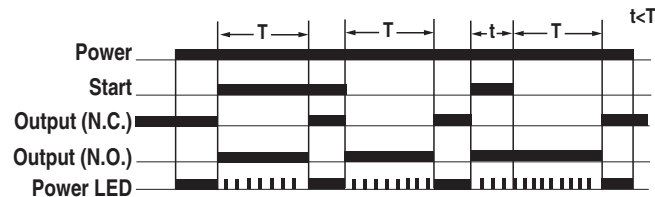

Basic Operation

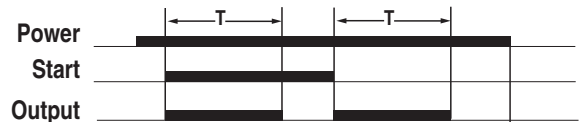

Mode D — Off-Delay (Trigger=Signal Off)

- Need continuous input power applied.
- Contacts change state immediately when start signal is applied.
- Timing is initiated by the trailing edge of the start signal.
- At the end of the time period contacts return to the shelf state.
- Relay timing is reset when additional start signals are applied while the relay is timing. Contacts remain in energized state.
- When the input power is removed contacts return to the shelf state.

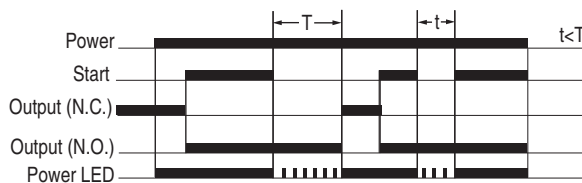

Basic Operation



Mode E — One-Shot (Trigger=Signal On) 700-HR52, -HRV, and -HRT6

- Need continuous input power applied.
- Timing is initiated by the leading edge of the start signal.
- Contacts change state immediately when start signal is applied.
- At the end of the time period contacts return to the shelf state.
- Relay timing is reset when additional start signals are applied while the relay is timing. Contacts remain in energized state.
- When the input power is removed contacts return to shelf state.

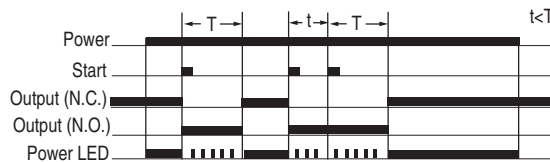

Basic Operation



Mode E — One-Shot (Trigger = Power On) 700-HRS, -HRP, and -HRT4

- Need continuous input power applied.
- Timing is initiated when the input power is applied.
- At the end of the time period contacts return to the shelf state.
- Relay timing is reset when input power is removed.

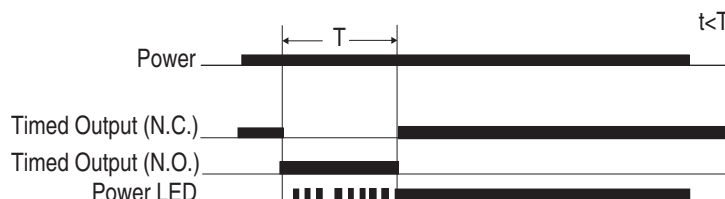

Basic Operation



Mode J — Delayed One-Shot (Trigger=Power On)

- a. Need continuous input power applied.
- b. No start signal applied.
- c. Timing is initiated when input power is applied.
- c. Contacts change state after the timing for a fixed time of 1s +/-0.5s
- d. At the end of the 1 sec period the contacts return to the shelf state.
- e. When the input power is removed contacts return to the shelf state.

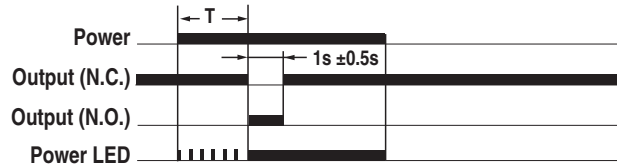

Basic Operation

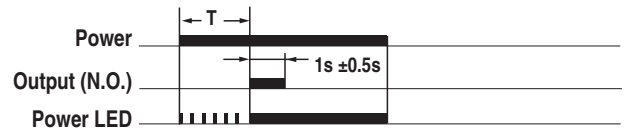

Mode Star-Delta

- a. Need continuous input power applied.
- b. No start signal required. Timing is initiated when input power is applied.
- c. Star output contact changes state when input power is applied.
- d. After timing is complete star output contact returns to the shelf state then both the star & delta contacts remain in shelf states until transfer time setting is complete.
- e. Delta output contact changes state after transfer time is complete.
- f. Instantaneous contact changes state when input power is applied.
- g. All contacts return to the shelf state when input power is removed.

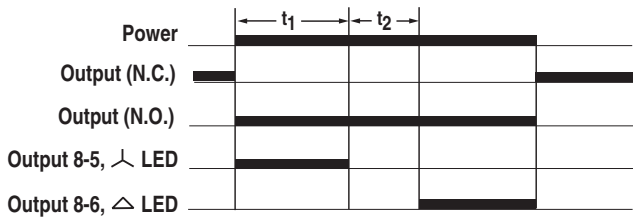

Basic Operation

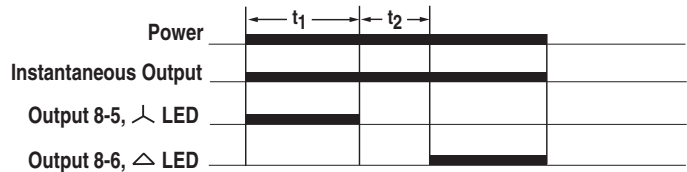

Mode True Off-Delay (Trigger=Power Off)

- a. Continuous input power is NOT required.
- b. No start signal applied.
- c. Contacts change state immediately when input power is applied.
- d. Timing starts when input power is removed.
- e. At the end of the time period contacts return to the shelf state.
- f. Relay timing is reset when input power is reapplied while the relay is timing. Contacts remain in energized state.

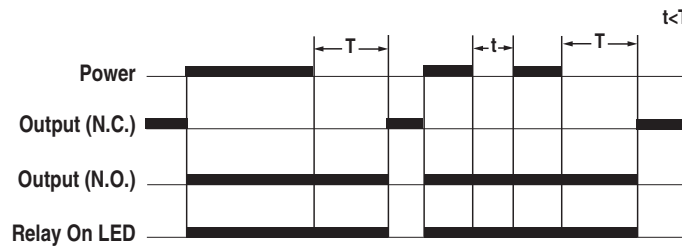

Basic Operation

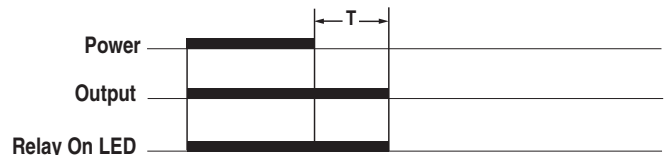

Approximate Dimensions

Approximate Dimensions are shown in millimeters (inches). Approximate Dimensions are not intended to be used for manufacturing purposes.

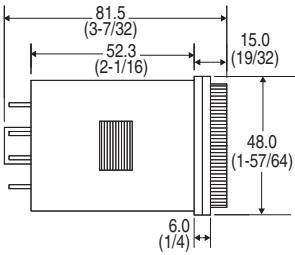

Cat. No. 700-HR, -HRM, -HRC, -HRF, -HRS, HRV, HRP Timing Relays

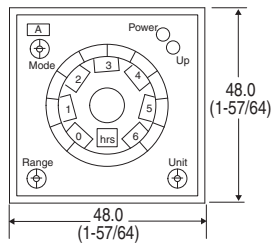

Cat. No. 700-HR, -HRM, -HRC, -HRF, -HRS, -HRV, -HRP, -HRY, -HRQ Timing Relays

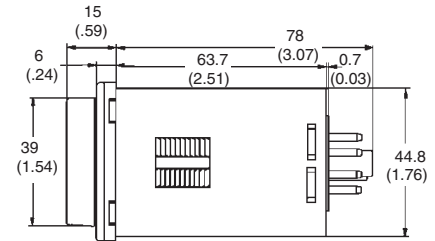

Cat. No. 700-HRY, -HRQ Timing Relays

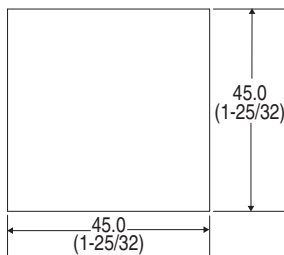

Cat. No. 700-HR... Panel Cutout

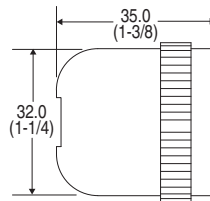

Cat. No. 700-HN129 — 11-pin
 Cat. No. 700-HN108 — 8-pin socket

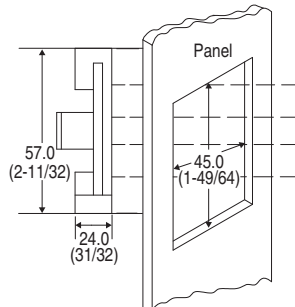

Cat. No. 700-HN130 Retainer

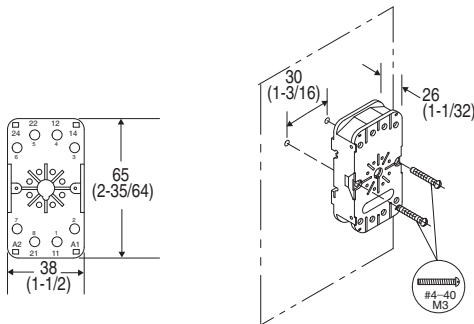

Cat. No. 700-HN100
 Wire Size: 2x2.5 mm
 Single Wire — Up to #12 AWG
 Double Wire — 2x2.5 mm (#2-14 AWG...#2-20 AWG)
 (Either Solid or Stranded)
 Strip Length: 9 mm (3/8 in) — Torque: 0.8 N•m (7 lb•in)

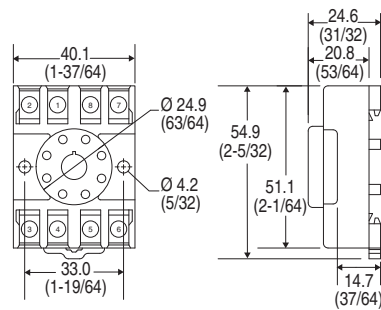

Cat. No. 700-HN125
 Wire Size: 2x2.5 mm
 Single Wire — Up to #12 AWG
 Double Wire — 2x2.5 mm (#2-14...#2-20 AWG)
 (Either Solid or Stranded)
 Strip Length: 9 mm (3/8 in) — Torque: 0.8 N•m (7 lb•in)

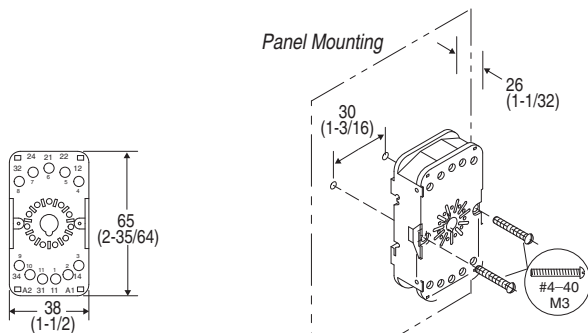

Cat. No. 700-HN100
 Wire Size: 2x2.5 mm
 Single Wire — Up to #12 AWG
 Double Wire — 2x2.5 mm (#2-14 AWG...#2-20 AWG)
 (Either Solid or Stranded)
 Strip Length: 9 mm (3/8 in.) — Torque: 0.8 N•m (7 lb•in.)

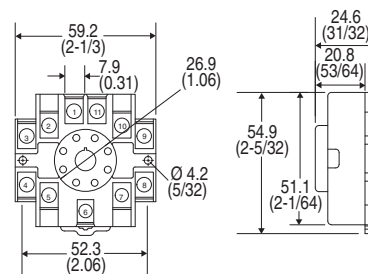

Cat. No. 700-HN126
 Wire Size: 2x2.5 mm
 Single Wire — Up to #12 AWG
 Double Wire — 2x2.5 mm (#2-14...#2-20 AWG)
 (Either Solid or Stranded)
 Strip Length: 9 mm (3/8 in) — Torque: 0.8 N•m (7 lb•in)



Bulletin 700-HX — Multi-Function Digital Timing Relay

- Digital timing relay with LCD display
- Socket- or panel-mounted (NEMA 4X/IP66)
- 5A, B300, SPDT contact ratings
- 10 Functions or modes
- Environmentally friendly — flash memory, no battery
- User Manual 700-UM002* available at Literature Library

Table of Contents

Product Selection this page

Accessories..... 9-97

Specifications..... 9-98

Approximate Dimensions..... 9-105

Standards Compliance and Certifications

See Specification table in this section, page 9-99.

Product Selection

Model	Operating Mode	Timing Range	Socket Type	Contact Output	No. of Pins	Input Voltage	Cat. No.
Cat. No. 700-HX...	A mode: Signal ON-Delay 1 A-1 mode: Signal ON-Delay 2 A-2 mode: Power ON-Delay 1 A-3 mode: Power On-Delay 2 B mode: Repeat Cycle 1 B-1 mode: Repeat Cycle 2 D mode: Signal OFF-delay E mode: One Shot F mode: Cumulative Z mode: On/Off duty adjustable repeat cycle S mode: stop watch toff: Flicker OFF start 1 ton: Flicker ON start 1 toff-1: Flicker OFF start 2 ton-1: Flicker ON start 2	0.000...9.999 s	700-HN100 700-HN125	SPDT	8	100...240V AC	700-HX86SA17
		0.000...99.99 s 0.000...999.9 s 0.000...9999 s 0.000...99 min 59 s 0.000...999.9 min 0.000...9999 min 0.000...99 hr 59 min 0.000...999.9 hr 0.000...9999 hr				24V AC 12...24V DC	700-HX86SU24

General Timer Functions

Display Section

- 1. Key Protect Indicator** (orange)
- 2. Control Output Indicator** (orange)
- 3. Reset Indicator** (orange)
- 4. Present Value Display** (Main display)
 (Character height: 12 mm, red *)
 * Characters on models with screw terminals can be switched between red, green, and orange.
- 5. Time Unit Indicators**
 (Color is same as present value display.)
 (If the time range is 0 min, 0 h, 0.0 h, or 0 h 0 min, these indicators flash to indicate timing operation.)
- 6. Set Value Display** (Sub-display)
 (Character height: 6 mm, green)
- 7. Set Value 1, 2 Indicator** (green)

Character Size for Present Value Display Character Size for Set Value Display

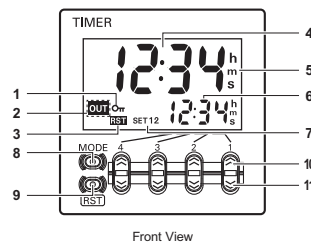
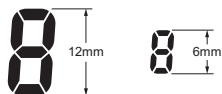

Front View

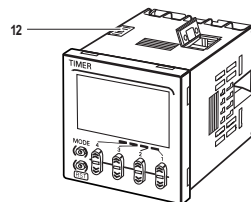





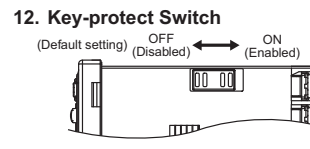

Operation Key

- 8. Mode Key**
 (Changes modes and setting items)
- 9. Reset Key**
 (Resets present value and output)
- 10. Up Keys 1 to 4**
- 11. Down Keys 1 to 4**

Switches

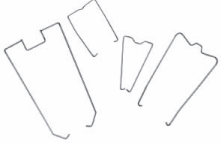

Accessories

	Description	Pkg. Quantity	Cat. No.
 <i>Cat. No. 700-HN100</i>	Screw Terminal Tube Base Socket — Panel or DIN Rail Mounting; Guarded Terminal Construction. 8-Pin for use with Bulletin 700-HX Timing Relays. Order ten or multiples of ten	10	700-HN100
 <i>Cat. No. 700-HN125</i>	Screw Terminal Tube Base Socket — Panel or DIN Rail Mounting; Open Style Construction. 8-Pin for use with Bulletin 700-HX Timing Relays. Order must be for 10 sockets or multiples of 10. No retainer clip required.	10	700-HN125
 <i>Cat. No. 199-DR1</i>	DIN (#3) symmetrical hat rail 35 x 7.5 x 1 m	10	199-DR1
 <i>Cat. No. 700-HN108</i>	Specialty Socket 8-pin backwired socket with solder terminals. For use with 700-HX Timing Relays.	10	700-HN108
 <i>Sample Retainer Clips</i>	Retainer Clip for Cat. Nos. 700-HN100 Sockets with all 700-HX Timing Relays Secures timer in socket. Note: Not required for installation	10	700-HN131
 <i>Cat. No. 700-HN130</i>	Frame Adapter For flush or door mounting of all Bulletin 700-HR and -HX timers.	1	700-HN130
 <i>Cat. No. 700-HN132</i>	Protective Cover Helps prevent tampering of timing and mode settings. Provides a degree of protection against water and dirt from entering the front of the relay. For use with all Bulletin 700-HRs and -HX timing relays.	1	700-HN132

Timing Relay, Socket, Retainer Clip Reference Chart

Timer Type	Socket Cat. No.	Retainer Clip Cat. No.
700-HX	700-HN100	700-HN131
	700-HN108	Not Required*
	700-HN125	Not Required*

* Design of socket holds the relay securely and does not require retainer clips.

Bulletin 700-HX
Plug-in Timing Relays
 Specifications

Specifications

Electrical Ratings		
Pilot Duty Rating		NEMA B300
Rated supply voltage		100 to 240V AC, 24V AC/12 to 24V DC (50/60Hz) (permissible ripple: 20%(p-p) max.)
Operating voltage range		85...110% of rated supply voltage
Power consumption	100...240V AC	4.3VA
	24V AC/12...24V DC	3.4VA/1.7 W
Inrush Current	100...240V AC	3 A
	24V AC/12...24V DC	5 A
Make ▶ ◀	120V AC	30 A
	240V AC	15 A
Break ◀ ▶	120V AC	3 A
	240V AC	1.5 A
Hp at 120V AC		1/4 Hp
Hp at 240V AC		1/3 Hp
Mechanical		
Mounting Method		Flush mounting, surface mounting, DIN mounting
Display		Seven-segment, negative transmissive LCD; Present value (red, 12 mm high characters); Set value (green, 6 mm high characters)
Digits		Four digits
Timer	Time ranges	0.000...9.999 s, 0.00...99.99 s, 0.0...999.9 s, 0...9999 s, 0 min 00 s...99 min 59 s, 0.0...999.9 min, 0 hr 00 min...99 hr 59 min, 0.0 hr...999.9 hr, 0 hr...9999 hr
	Timer modes	Elapsed time (Up), remaining time (Down), selectable
	Output modes	A, A-1, A-2, A-3, B, B-1, D, E, F, Z, S, tOFF, tON, tOFF-1, or tON-1
Inputs	Input signals	Start, reset
	Input method	No-voltage input via:NPN transistor or switching of contact
	Start, reset, gate	Minimum input signal width: 1 or 20 ms (selectable)
	Power reset	Minimum power-opening time: 0.5 s (Except for A-3, B-1, and F mode)
Control output		SPDT contact output: 5 A at 250V AC, resistive load (cosine=1) Minimum applied load: 10 mA at 5 V DC (failure level: P, reference value)
External Power Supply		No
Key Protect		Yes
Memory Backup		EEP-ROM (overwritten 100 000 times min), which can store data for 10 years min.
Accuracy of Operating Time and Setting Error*		Power-ON start: +-0.01% +-50 ms max. * to be rated against set value Signal start: +- 0.005% +-30 ms max. * to be rated against set value Signal start at transistor output model: +- 0.005% +-3 ms max.* If the set value is within the sensor waiting time (250 ms max.)

* The values are based on the set value.

* The value is applied for a minimum pulse width of 1 ms.

		Characteristics*
Insulation Resistance		100 mΩ min. (at 500V DC)
Dielectric Strength		2000V AC, 50/60Hz for 1 min between current-carrying terminals and non-current-carrying metal parts (1000V AC for 24V AC/12 to 24V DC type), 1000 VAC, 50/60 Hz for 1 min between non-continuous contacts
Noise Immunity		'+-1.5 kV (between power terminals) for 100 to 240 VAC, +-480V for 24VAC/12 to 24VDC, and +-600V (between input terminals), square-wave noise by noise simulator (pulse width: 100 ns/1 μs, 1-ns rise)
Static Immunity		±8 kV (malfunction), ±15 kV (destruction)
Vibration Resistance	Malfunction	10...55 Hz with 0.35 mm single amplitude each in three directions for 10 min
Shock Resistance	Malfunction	98 m/s ² (approx. 10 G) each in three directions
Life Expectancy	Mechanical	10 million operations min. (under no load at 18 000 operation/hr)
	Electrical	100 000 operations min. (5 A at 250V AC, resistive load at 1800 operation/hr)
EMC	(EMI)	EN61812-1
	Emission Enclosure:	EN55011 Group1 class A
	Emission AC mains:	EN55011 Group1 class A
	(EMS)	EN61812-1
	Immunity ESD:	EN61000-4-2: 4 kV contact discharge (level2) 8 kV air discharge (level3)
	Immunity RF-interference:	EN61000-4-3: 10 V/m
Enclosure Ratings		Panel surface:IP66 and NEMA Type 4X (indoors)*
Weight		Approx. 100 g
Certifications		CE Certified; cURus (File No. E14843, Guide NRNTZ/NRNT8), C-Tick Marked
Standards		EN61010-1, EN 61326, VDE0106/P 100, CSA C22.2 No. 14, UL 508

* 700-HX User Manual, pub. number 700-UM002_-EN-D, available at Literature Library.

* An attached waterproof packing is necessary to ensure IP66 waterproofing between the 700-HX and installation pan.

Timing Charts

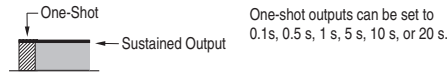

Output Mode A Mode: Signal ON-Delay (Timer resets when power comes ON.)

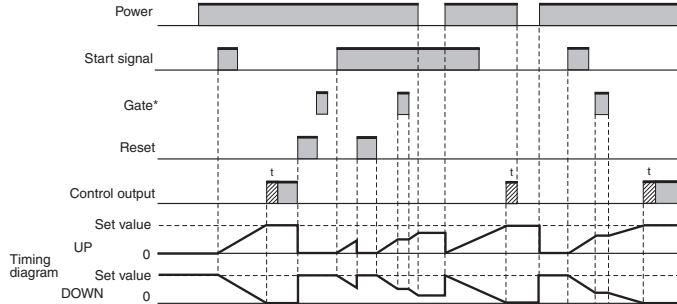

Timing starts when the start signal goes ON. While the start signal is ON, the timer starts when power comes ON or when the reset input goes OFF. The control output is controlled using a sustained or one-shot time period.

Basic Operation

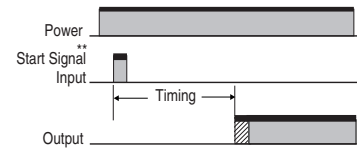

*Output is instantaneous when setting is 0.
 ** Start signal input is enabled during timing.

Output Mode A-1: Signal ON-Delay 2 (Timer resets when power comes ON.)

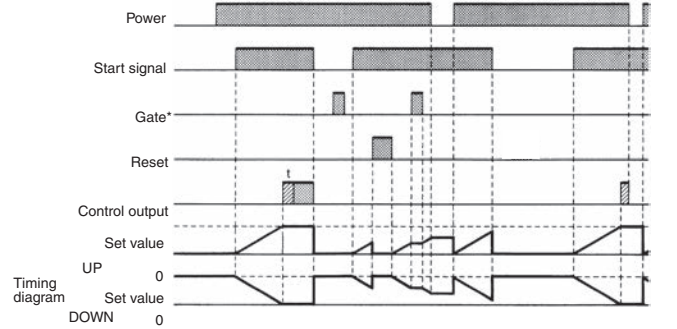

Timing starts when the reset input goes ON and is reset when the start signal goes OFF. While the start signal is ON, the timer starts when the power comes ON or when the reset input goes OFF. The control output is controlled using a sustained or one-shot time period.

Basic Operation

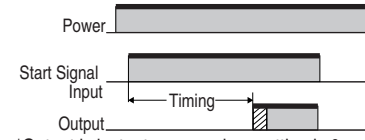

*Output is instantaneous when setting is 0.

Output Mode A-2: Power ON Delay 1 (Timer resets when power comes ON)

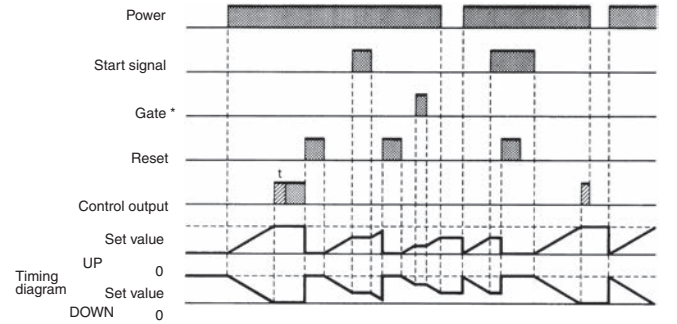

Timing starts when the reset input goes OFF. The start signal disables the timing function (i.e., same function as the gate input). The control output is controlled using a sustained or one-shot time period.

Basic Operation

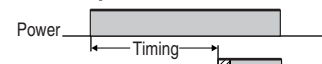

*Output is instantaneous when setting is 0.

Output Mode A-3 Power ON Delay 2 (Timer does not reset when power comes ON)

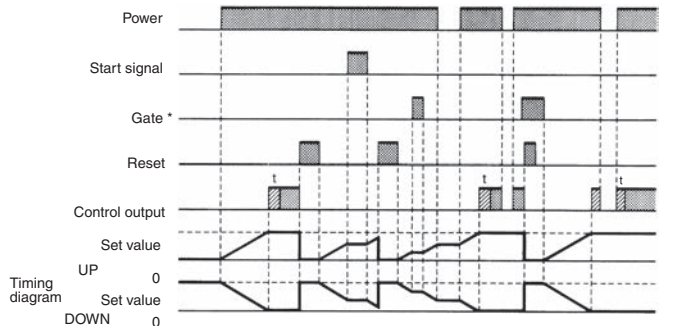

Timing starts when the reset input goes OFF. The start signal disables the timing function (i.e., same function as the gate input). The control output is controlled using a sustained or one-shot time period.

Basic Operation



*Output is instantaneous when setting is 0.

9

* Gate not included on any mode of this relay.

Output Mode B: Repeat Cycle (Timer resets when power comes ON.)

Sustained Output

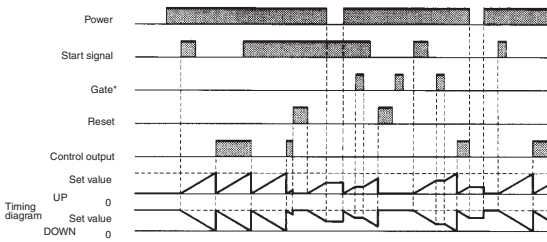

Timing starts when the start signal goes ON. The status of the control output is reversed when time is up (OFF at start). While the start signal is ON, the timer starts when the power comes ON or when the reset input goes OFF.

Basic Operation

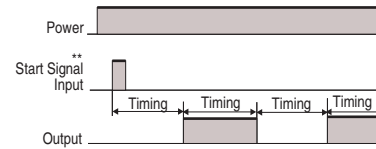

* Normal output operation will not be possible if the set time is too short. Set the value to at least 100 ms (contact output type).
 ** Start signal input is disabled during timing.

One-Shot Output

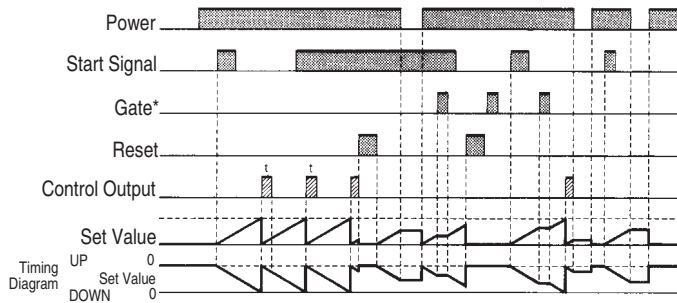

Timing starts when the start signal goes ON. The control output is turned ON when time is up. While the start signal is ON, the timer starts when the power comes ON or when the reset input goes OFF.

Basic Operation

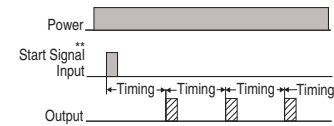

* Normal output operation will not be possible if the set time is too short. Set the value to at least 100 ms (contact output type).
 ** Start signal input is disabled during timing.

Output Mode B-1: Repeat Cycle 2 (Timer does not reset when power comes ON)

Sustained Output

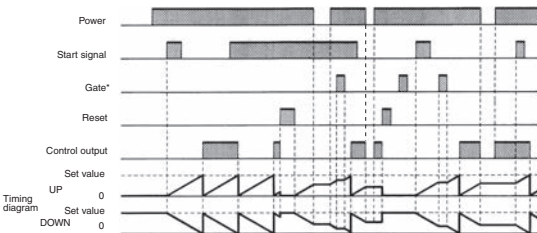

Timing starts when the start signal goes ON. The status of the control output is reversed when time is up (OFF at start). While the start signal is ON, the timer starts when the power comes ON or when the reset input goes OFF.

Basic Operation

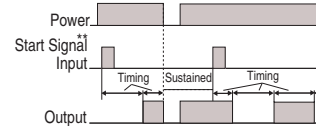

* Normal output operation will not be possible if the set time is too short. Set the value to at least 100 ms (contact output type).
 ** Start signal input is disabled during timing.

One-Shot Output

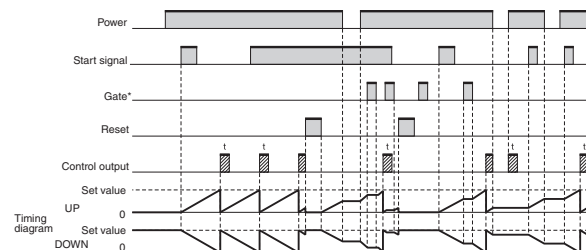

Timing starts when the start signal goes ON. The control output comes ON when time is up. While the start signal is ON, the timer starts when the power comes ON or when the reset input goes OFF.

Basic Operation

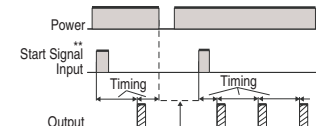

* Normal output operation will not be possible if the set time is too short. Set the value to at least 100 ms (contact output type).
 ** Start signal input is disabled during timing.

* Gate not included on any mode of this relay.

Output Mode D: Signal OFF-Delay (Timer resets when power comes ON.)

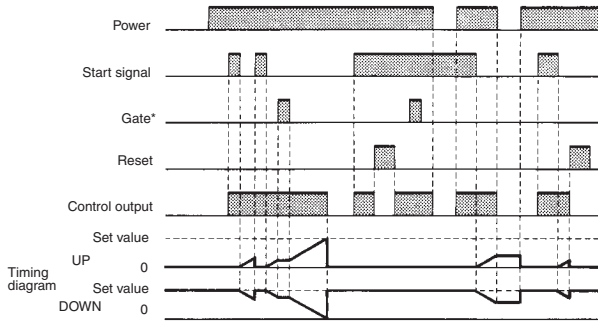

The control output is ON when the start signal is ON (except when the power is OFF or the reset is ON).
 The timer is reset when the time is up.

Basic Operation

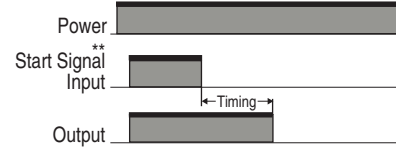

* Output functions only during start signal input when setting is 0.
 ** Start signal input is enabled during timing.

Output Mode E: Interval (Timer resets when power comes ON.)

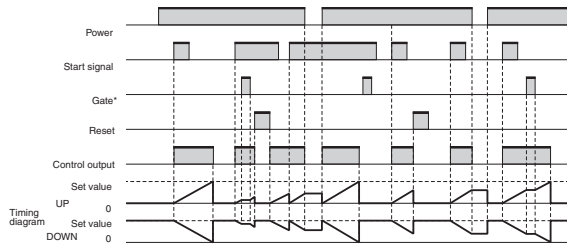

Timing starts when the start signal comes ON.
 The control output is reset when time is up.
 While the start signal is ON, the timer starts when power comes ON or when the reset input goes OFF.

Basic Operation

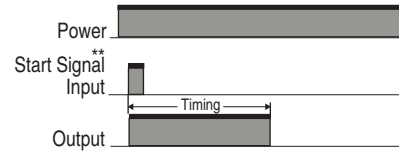

* Output is disabled when the setting is 0.
 ** Start signal input is enabled during timing.

Output Mode F: Cumulative (Timer does not reset when power comes ON)

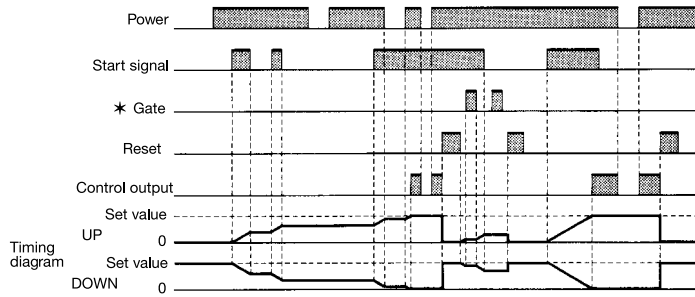

Start signal enables timing (timing is stopped when the start signal is OFF or when the power is OFF).
 A sustained control output is used.

Basic Operation

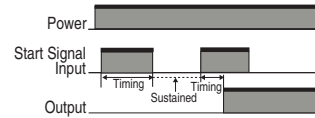

*Output is instantaneous when setting is 0.

* Gate not included on any mode of this relay.

Z Mode

Output quantity can be adjusted by changing the cycle time set in the adjustment level to 1 and by changing the ON duty (%) set value. The set value shows the ON duty (%) and can be set to a value between 0 and 100 (%). When the cycle time is 0, the output will always be OFF. When the cycle time is not 0 and when ON duty has been set to 0 (%), the output will always be OFF. When ON duty has been set to 100 (%), the output will always be ON.

Z mode: ON/OFF-duty Adjustable Repeat Cycle

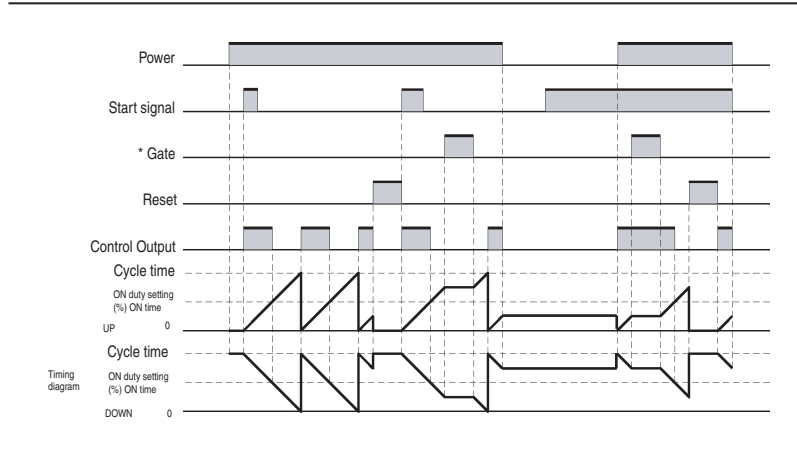

Timing starts when the start signal goes ON. The status of the control output is reversed when time is up (ON at start). While the start signal is ON, the timer starts when power comes ON or when the reset input goes OFF.

Basic Operation

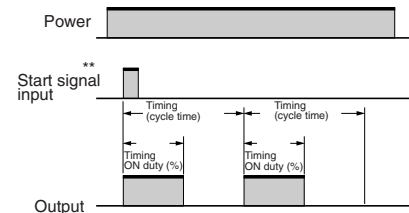

* Normal output operation will not be possible if the set time is too short. Set the value to at least 100 ms (contact output type).
 ** Start signal input is enabled during timing.

Output Mode S: Stop Watch (Timer resets when power comes ON)

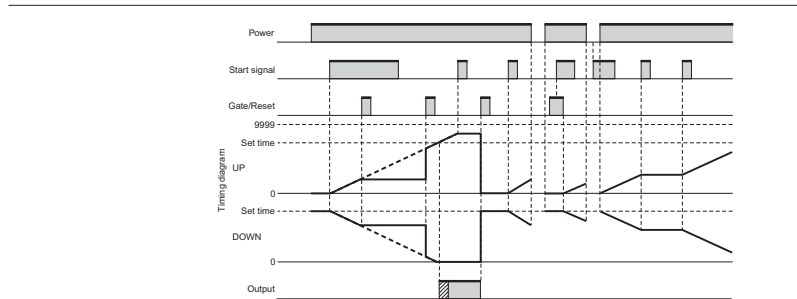

The signal starts and stops timing. The display is held and timing is continued if the reset or gate input is received during timing operation. The timer resets if the reset or gate input is received when the timing operation is stopped.

Basic Operation

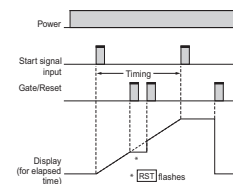

Note: Output is instantaneous when setting is 0.

Output Mode T OFF: Twin Timer OFF start

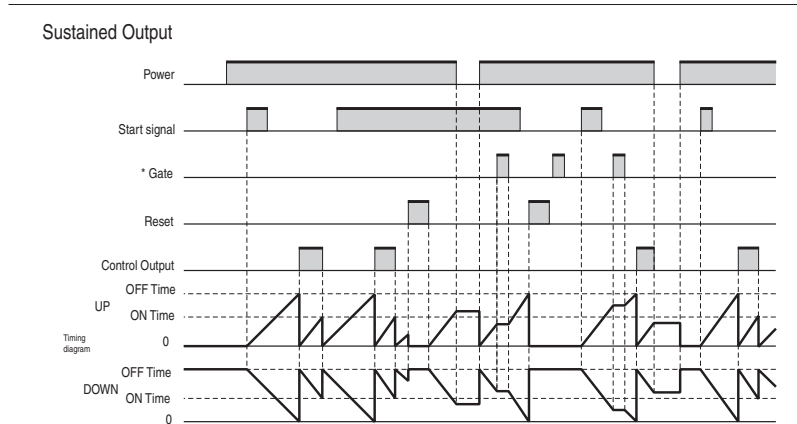

Timing starts when the start signal goes ON. The status of the control output is reversed when time is up (OFF at start). While the start signal is ON, the timer starts when power comes ON or when the reset input goes OFF.

Basic Operation

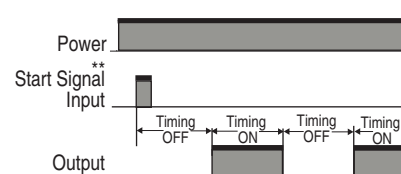

* Normal output operation will not be possible if the ON/OFF set time is too short. Set the value to at least 100 ms (contact output type).
 ** Start signal input is disabled during timing.

* Gate not included on any mode of this Relay.

Output Mode T ON: Twin Timer ON start

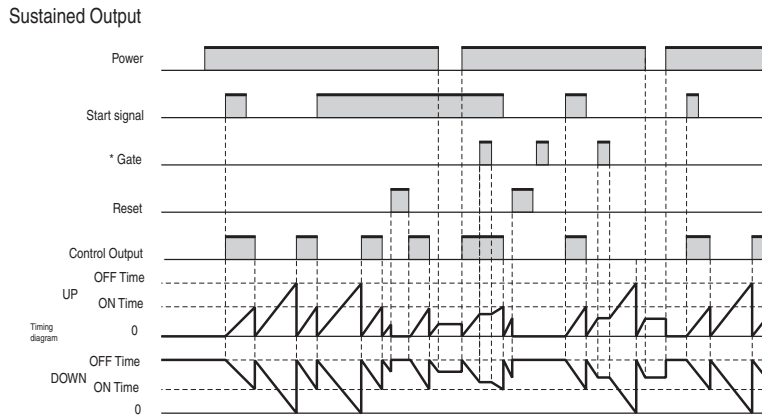

Timing starts when the start signal goes ON.
 The status of the control output is reversed when time is up (ON at start).
 While the start signal is ON, the timer starts when power comes ON or when the reset input goes OFF.

Basic Operation

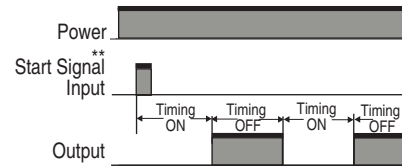

* Normal output operation will not be possible if the ON/OFF set time is too short. Set the value to at least 100 ms (contact output type).
 ** Start signal input is disabled during timing.

Output Mode TOFF-1: Flicker OFF start 2 (Timer does not reset when power comes ON)

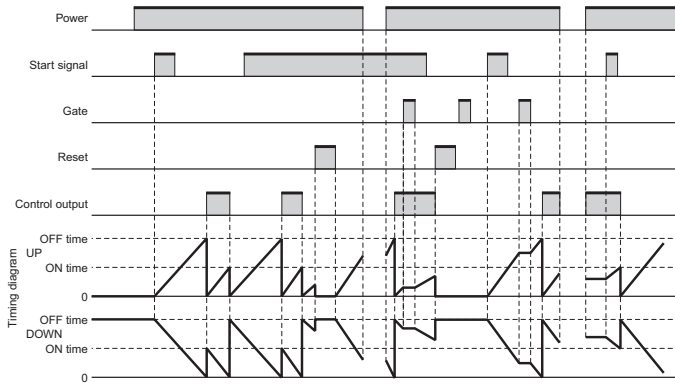

Timing starts when the start signal goes ON.
 The status of the control output is reversed when time is up (OFF at start).
 While the start signal is ON, the timer starts when the power comes ON or when the reset input goes OFF.

Basic Operation

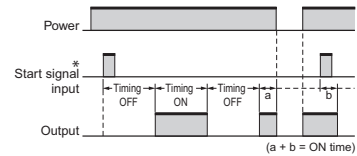

* Start signal input is disabled during timing.
Note: Normal output operation will not be possible if the set time is too short. Set the value to at least 100 ms (contact output type).

Output Mode TON-1: Flicker ON start 2 (Timer does not reset when power comes ON)

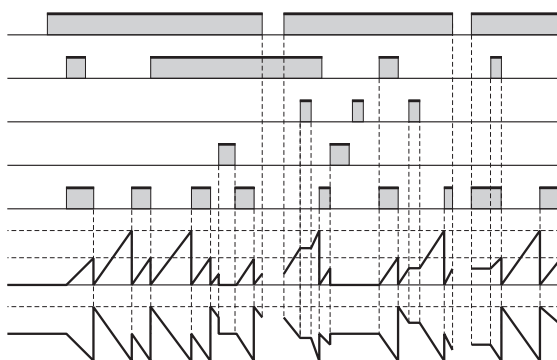

Timing starts when the start signal goes ON.
 The status of the control output is reversed when time is up (ON at start).
 While the start signal is ON, the timer starts when the power comes ON or when the reset input goes OFF.

Basic Operation

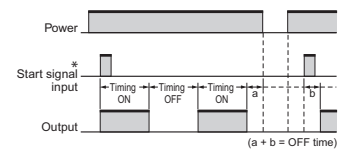

* Start signal input is disabled during timing.
Note: Normal output operation will not be possible if the set time is too short.

* Gate not included on any mode of this Relay.

Approximate Dimensions

Approximate Dimensions are shown in millimeters (inches). Approximate Dimensions are not intended to be used for manufacturing purposes.

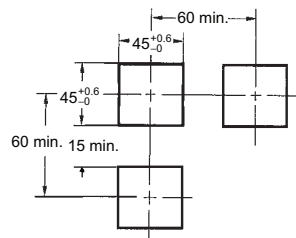
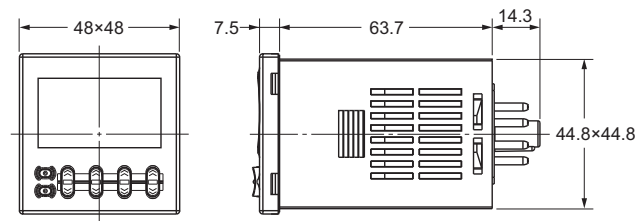

Cat. No. 700-HX...
Panel Cutout

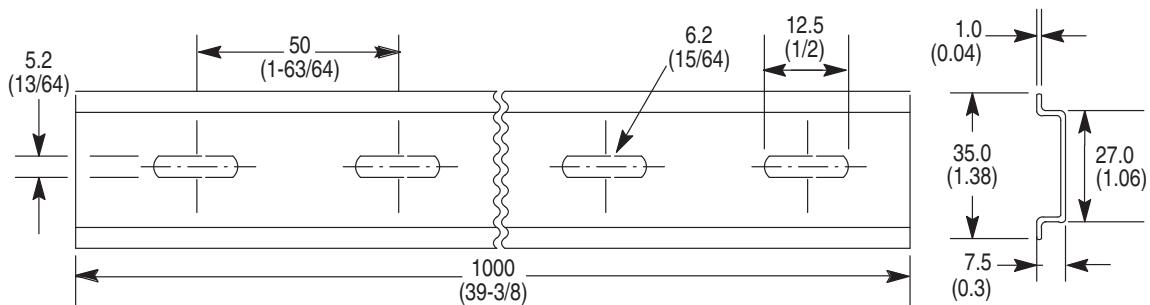

Cat. No. 199-DR1 DIN Mounting Rail Series B
Cat. No. 199-DR4 DIN Mounting Rail Series B Has No Mounting Holes

Terminal Arrangement

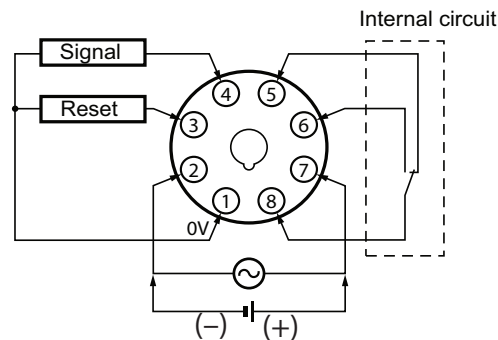

Cat. No. 700-HX...

Plug-in Timing Relays

Product Overview/Product Selection



Bulletin 700-HXM — Preset Counter/Timing Relay

- One of the world's smallest preset digital timers
- Panel-mounted (1/32 DIN cut out)
- Built-in prescaling for counter operation
- Finger protection terminal block (VDE0106/P100)
- NEMA 4/ IP66
- User Manual 700-UM001_-EN-D available at Literature Library

Table of Contents

Product Selection this page

Accessories..... 9-107

Approximate Dimensions..... 9-112

Standards Compliance and Certifications

See Specification table in this section, page 9-107

Product Selection

Model	Operating Modes	Counter Modes*		Timing Range	Counter Range	Input Voltage	Cat. No.
		Input	Output				
 Cat. No 700-HXM...	A mode: Signal ON-delay B mode: Repeat Cycle D mode: Signal OFF-delay E mode: One Shot F mode: Accumulative Z mode: ON/OFF-duty Adjustable Repeat Cycle	Increment Decrement Individual Quadrature	N, F, C, K	0.000...9999 hr	-999...9999	24V DC	700-HXM66SZ24

* For counter mode explanation, see page 9-109.

General Timer Functions

No. 1 Display
Displays the present value or parameter type. When totalizing count is displayed, the leftmost four digits of the 8-digit totalizing count will be displayed (Zeros suppressed).

Operation Display 1
Displays the time unit when the timer function has been selected

Example

h	5:30
min	123.4
s	

Level Key
Displays the present value or parameter type. When totalizing count is displayed, the leftmost four digits of the 8-digit totalizing count will be displayed (Zeros suppressed).

Mode Key
Press this key to select parameters within each level.

Down Key
Each press of this key decreases values displayed on the No. 2 display. Hold down this key continuously to decrease values quickly. Also returns setting items.

Up/Reset Key
Each press of this key increases values displayed on the No. 2 display. Hold down this key continuously to increase values quickly. Also advances setting items. To reset the present value, press this key while the present value is displayed. If this key is pressed while the totalizing count value is displayed, the totalizing count value and the present value will be reset.

Operation Display 2

Indicator	Meaning
RST	Lit during reset using reset input or Reset Key.
OUT	Lit when control output is ON.
TOTAL	Lit when totalizing value is displayed.

No. 2 Display
Displays set value or set value of the parameter. Displays the rightmost four digits of the count value when the 700-HXM is used as a totalizing counter (Zero suppressed).

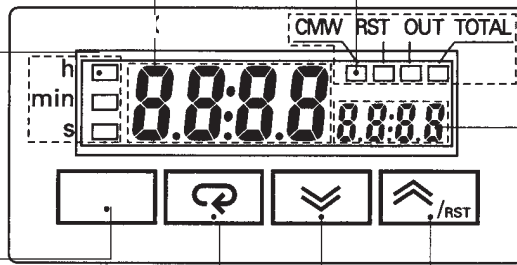

Accessories

	Description	Pkg. Quantity	Cat. No.
 Cat. No. 700-HN141	Replacement Flush Mounting Adapter (One shipped with each 700-HXM66Z24)	1	700-HN141

Specifications

Electrical Ratings			
Pilot Duty Rating	NEMA B300		
Rated Supply Voltage	24V DC		
Operating Voltage Range	85...110% of rated supply voltage		
Power Consumption	1.5 W max. (for max. DC load) (Inrush current: 15 A max.)		
Make	▶ ◀	120V AC	30 A
		240V AC	15 A
Break	◀ ▶	120V AC	3 A
		240V AC	1.5 A
Hp at 120V AC			1/4 Hp
Hp at 240V AC			1/3 Hp
Mechanical			
Mounting Method	Flush mounting (Panel or door)		
Terminal Screw Tightening Torque	0.5 N•m max.		
Display	Seven-segment, negative transmissive LCD; time display (hr, min, s); CMW, OUT, RST, TOTAL Present value (red, 7 mm high characters); Set value (green, 3.4 mm high characters)		
Digits	PV: Four digits SV: Four digits When total count value is displayed: eight digits (Zeros suppressed)		
Memory Backup	EEPROM (non-volatile memory) (number of writes: 100 000 times)		
Counter	Maximum counting speed	30 Hz or 5 kHz*	
	Counting range	-999...9,999	
	Input modes	Increment, decrement, individual, quadrature inputs	
	Output modes	N, F, C, or K	
Timer	Time ranges	0.000...9.999 s, 0.00...99.99 s, 0.0...999.9 s, 0...9999 s, 0 min 00 s...99 min 59 s, 0.0...999.9 min, 0 h 00 min...99 h 59 min, 0.0...999.9 hr, 0 h...9999 hr	
	Timer modes	Elapsed time (Up), remaining time (Down)	
	Output modes	A, B, D, E, F, or Z	
Inputs (OV input)	Input signals	For Counter: CP1, CP2, and reset For Timer: Start, gate, and reset	
	Input method	No-voltage input (contact short-circuit and open input) Short-circuit (ON) impedance: 1 KΩ max. (Approx. 2 mA runoff current at 0Ω) Short-circuit (ON) residual voltage: 2V DC max. Open (OFF) impedance: 100 kΩ min. Applied voltage: 30V DC max.	
	Start, reset, gate	Minimum input signal width: 1 or 20 ms (selectable)	
	Power reset	Minimum power-opening time: 0.5 s	
Control Output	SPDT contact output: 5 A at 250V AC/30V DC, resistive load (cos φ = 1)		
Minimum Applied Load	10 mA at 5V DC (failure level: P, reference value)		
Reset System	External, manual, and power supply resets (for timer in A, B, D, E, or Z modes)		
Sensor Waiting Time	260 ms max. (Inputs cannot be received during sensor wait time if control outputs are turned OFF)		

* The figures given for maximum counting speed are for incrementing or decrementing operation with a prescale value of x1. If prescaling is used and 5 kHz is set, the maximum counting speed will be reduced to about half. The non-prescaling maximum counting speed will also be reduced to about half when the up/down mode is selected.

* "700-HXM User Manual" pub. no. 700-UM001*

Bulletin 700-HXM
Plug-in Timing Relays
 Specifications

Characteristics		
Timer Function		Signal start: $\pm 0.03\% \pm 30$ ms max. Power-ON start: $\pm 0.03\% \pm 50$ ms max.
Insulation Resistance		100 m Ω min. (at 500V DC)
Dielectric Strength		1500V AC, 50/60 Hz for 1 min between output terminals and non-current-carrying metal parts 510V AC, 50/60 Hz for 1 min between current-carrying terminals (except output terminals) and non-current-carrying metal parts 1500V AC, 50/60 Hz for 1 min between output terminals and current-carrying terminals (except output terminals) 500V AC, 50/60 Hz for 1 min between communications terminals and current-carrying terminals (except output terminals) 1000V AC, 50/60 Hz for 1 min between contacts not located next to each other
Noise Immunity		Square-wave noise by noise simulator; ± 480 V (between power terminals), ± 600 V (between input terminals)
Static Immunity		± 8 kV (malfunction), ± 15 kV (destruction)
Vibration Resistance	Malfunction	10...55 Hz with 0.35 mm single amplitude each in three directions for 10 min.
Shock Resistance	Malfunction	100 m/s ² (approx. 10 G), 3 times each in six directions
Life Expectancy	Mechanical	10 million operations
	Electrical	100 000 operations min (3 A at 250V AC, resistive load)
Ambient Temperature	Operating	-10...55 °C (with no icing or condensation)
	Storage	-25...65 °C (with no icing or condensation)
Ambient humidity		25...85%
EMC		(EMI): Emission Enclosure: EN61326 Class A (EMS): EN61326 Immunity ESD: EN61000-4-2: 4 kV contact discharge (level 2) 8 kV air discharge (level 3) Immunity RF-interference: EN61000-4-3: 10 V/m (Amplitude-modulated, 80 MHz...1 GHz) (level 3); 10 V/m (Pulse-modulated, 900 MHz ± 5 MHz) (level 3) Immunity Conducted Disturbance: EN61000-4-6: 3 V (0.15...80 MHz) (level 2) Immunity Burst: EN61000-4-4: 2 kV power-line (level 3); 1 kV I/O signal-line (level 4); 1 kV communications-line (level 3) Immunity Surge: EN61000-4-5: 1 kV between lines (power and output lines) (level 3); 2 kV between grounds (power and output lines) (level 3)
Enclosure Ratings		Panel surface: IP66 and NEMA Type 4 (indoors) Rear case: IP20 Terminal block: IP20
Weight		Approx. 80 g
Certifications		cURus Recognized Component (File No. E14843, Guide NRNT2/NRNT8), CE Marked, C-Tick Marked
Standards		EN61010-1, EN 61326, UL 508, CSA C22.2 No. 14



Input/Output Modes and Count Values

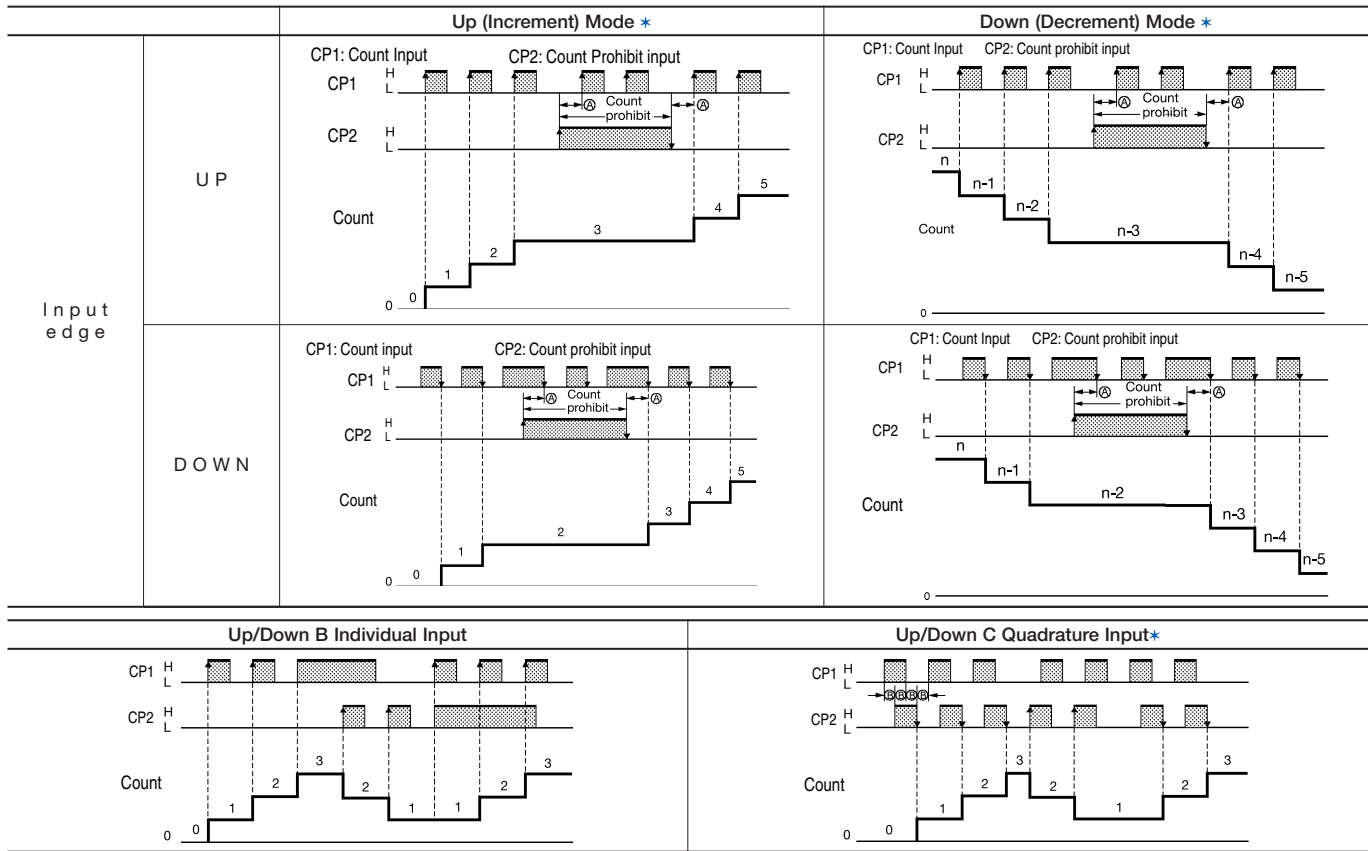

Note: H = Short-circuited
 L = Open

* (A) indicates the minimum signal width and (B) requires at least 1/2 the minimum signal width. If these conditions are not met, a counting error (+1 or -1) may occur.

Input/Output Mode Settings

Counter Function

If there is a power failure during output ON, output will turn ON again when the power supply has recovered. For one-shot output, an output will be made again for the duration of the output time setting once the power supply has resumed. Output timing restarted during one-shot outputs is ignored.

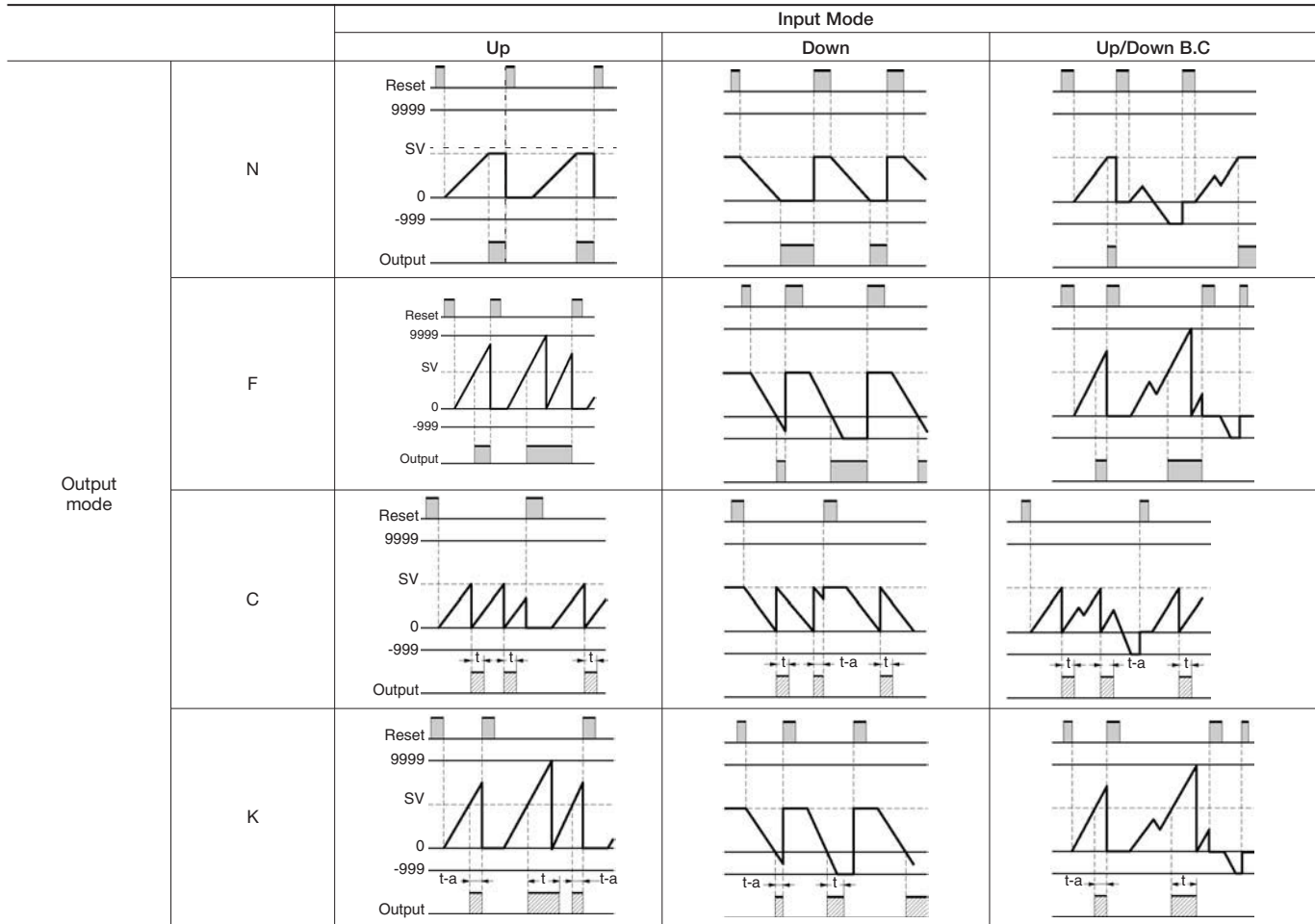

Note: t-a: Less than the output time
 t: Output time

Totalizing Counter Operation

9

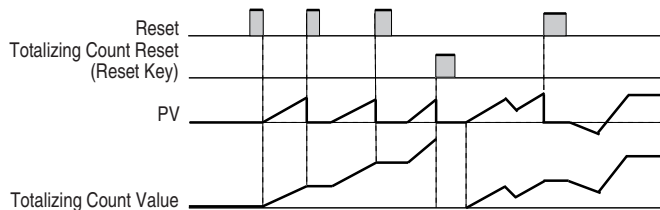

- Totalizing counter continues to count the present value, regardless of whether a reset input (by the reset key) has been made to reset the PV.
- When totalizing count value has reset, the PV is reset at the same time.
- The totalizing count range is 0...99999999. If the totalizing count exceeds 99999999, the count returns to 0. If the count drops below 0, it becomes 99999999.

Timer Function

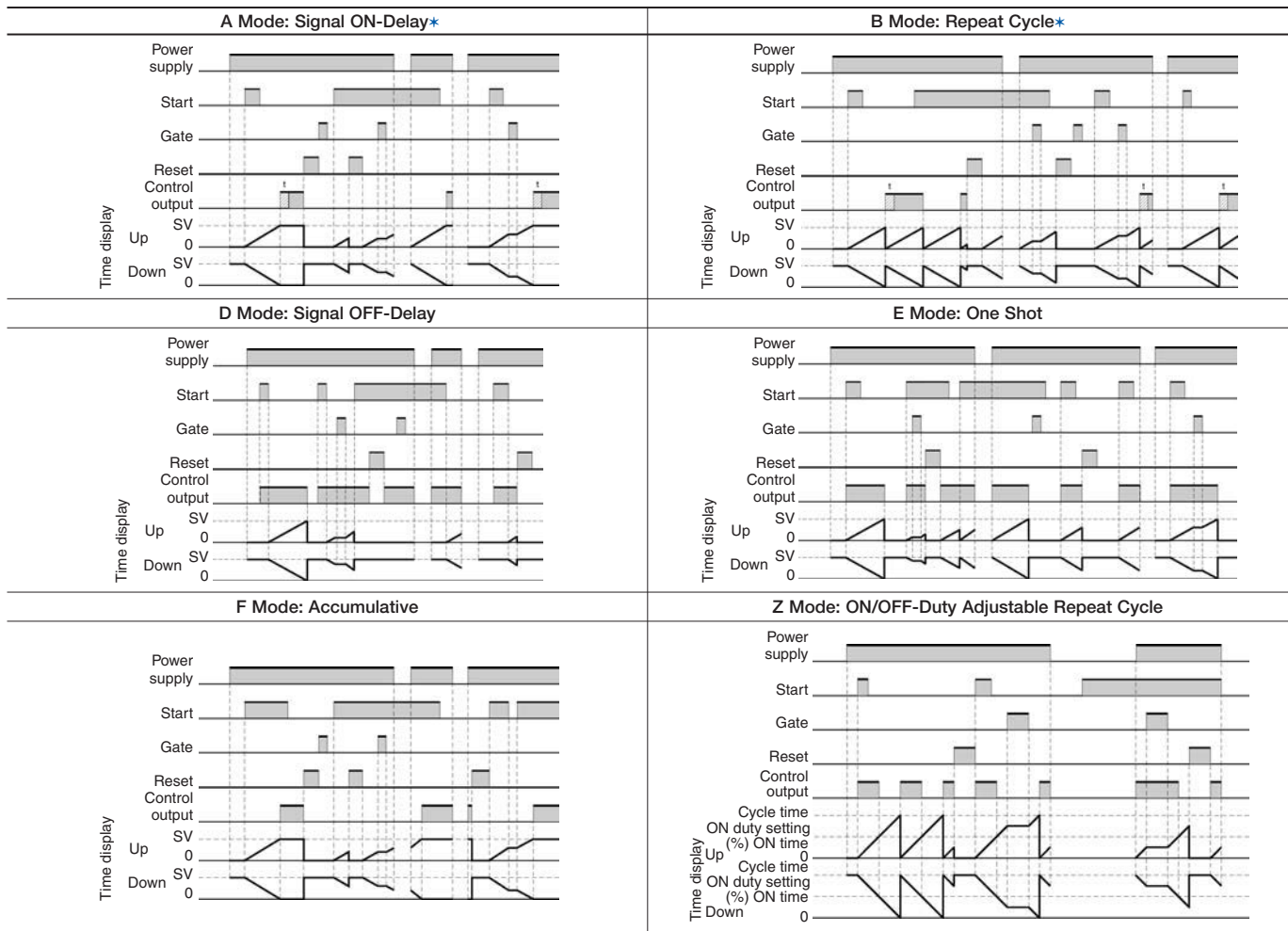

Z Mode

Output quantity can be adjusted by changing the cycle time set in the adjustment level to 1 and by changing the ON duty (%) set value. The set value shows the ON duty (%) and can be set to a value between 0 and 100 (%). When the cycle time is 0, the output will always be OFF. When the cycle time is not 0 and when ON duty has been set to 0 (%), the output will always be OFF. When ON duty has been set to 100 (%), the output will always be ON.

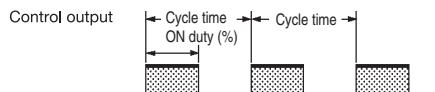

* One-shot output or HOLD output can be selected for output:



Bulletin 700-HXM
Plug-in Timing Relays
 Approximate Dimensions

Approximate Dimensions are shown in millimeters (inches). Approximate Dimensions are not intended to be used for manufacturing purposes.

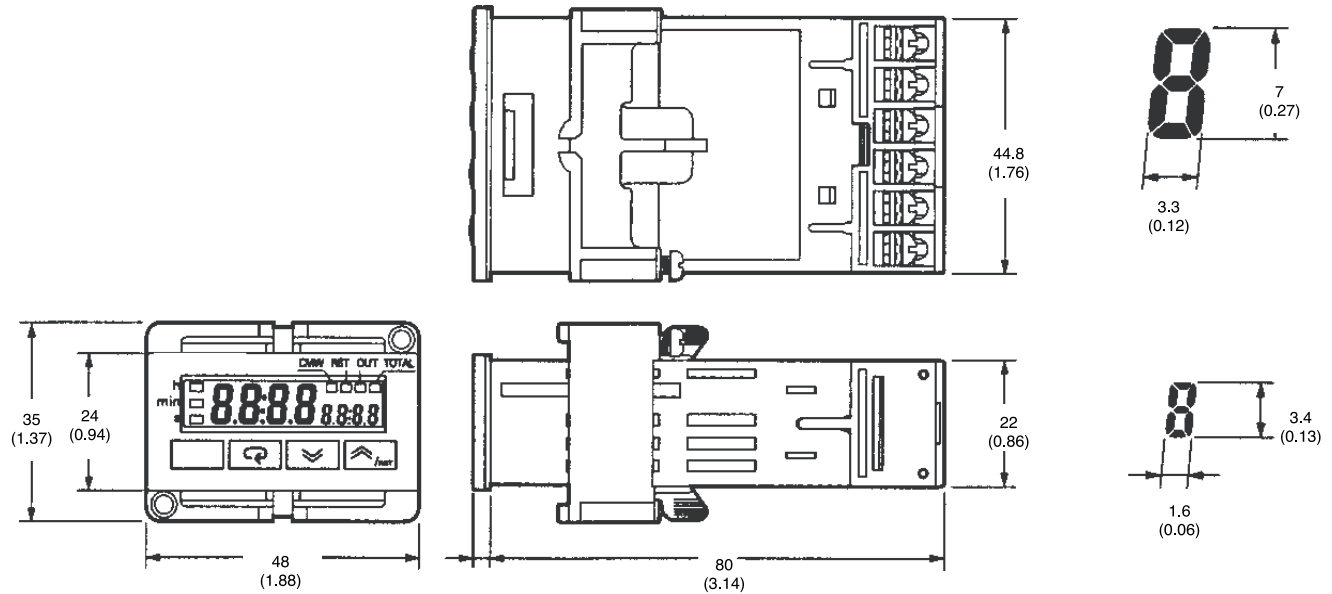

Cat. No. 700-HXM...

Terminal Arrangement

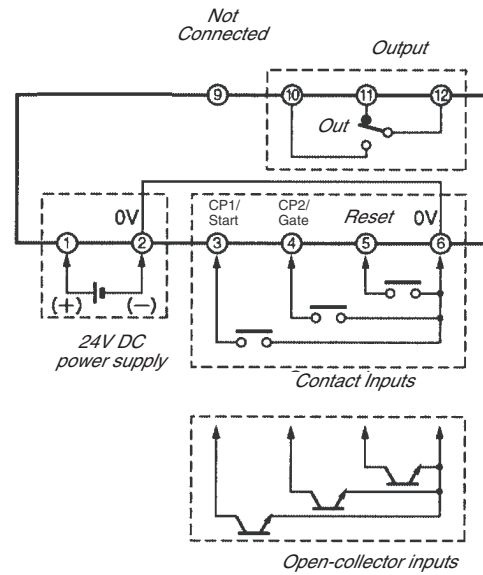

Cat. No. 700-HXM...

Bulletin No.	700-CF and 700-S-CF	700-K	700-P and 700S-P	700-PK	700-R
Type	Control Relay	Miniature Control Relay	Heavy-duty control relay	Heavy-duty control relay	Sealed Switch
Features	<ul style="list-style-type: none"> • Mechanically linked contacts • Timer and latch operations • Switch up to 690V AC and DC • Bulletin 700S-CF for safety circuits 	<ul style="list-style-type: none"> • Smallest size • Long life • Low power consumption • Switch up to 690V AC and DC 	<ul style="list-style-type: none"> • Convertible contacts • Up to 600V AC & DC • Very long life • Timer & latch options • Mechanically linked • Bulletin 700S-P for safety circuits 	<ul style="list-style-type: none"> • Five contact styles • Mechanically linked contacts • Timer and latch options • Switch up to 600V AC and DC 	<ul style="list-style-type: none"> • Hazardous location ratings • Long life in dirty environment • Timer and latch options • Switch 600V AC, 300V DC
Contact Form	4...12 Poles, double break	4...8 Poles Double Break	2...12 poles, double break	2...12 poles	2...8 Poles
Contact Type	Cross stamp or bifurcated	Bifurcated	Bifurcated double break	Double break	Sealed Switch
Contact Material	Silver, gold	Silver	Bifurcated silver nickel	Single silver CAD	Sealed Switch
Electrical					
Max. Current AC Resistive	20 A (relay) 10 A (adder deck)	10 A	10 A	20 A	5 A
Min. load	17V, 10 mA (Silver) 5V, 3 mA (Gold)	15V, 2 mA (700-K)	10V, 50 mA 1 mA, 5V with Bulletin 700-CPR	10V, 100 mA	1 mA, 5V
Coil Voltage	12...600V AC 9...250V DC	12...600V AC 9...250V DC	24...600V AC 6...600V DC	24...600V AC 6...600V DC	24...240V AC 24...250V DC
Coil Voltage Pickup	85...110% AC coils, 80...110% DC coils	85...110% AC Coils, 80...110% DC Coils	85...110% AC coils, 80...110% DC coils	85...110% AC coils, 80...110% DC coils	85...110% AC Coils, 80...110% DC Coils
Dielectric Withstand	2640V	2640V	2640V	2640V	2640V
Reference					
Electric Service Life (cycles)	1.2 million at 10 A	800K at 10 A, 120V AC	10 million at 10 A, 120V AC	1.5 million at 10 A, 120V AC	1.5 million at 5 A, 120V AC
Certifications	CE, cULus, CCC	CE, cULus, CCC	cULus, CE	cULus, CE	UL, CSA, CE
Sockets	DIN Rail or panel mount	DIN Rail or panel mount	DIN Rail, relay rail, or panel mount	DIN Rail, relay rail, or panel mount	Panel or rail mount
Page Number	page 9-147	page 9-162	page 9-115 and page 9-128	page 9-115	page 9-136

Bulletin 700
Industrial Relays
 Product Overview

Bulletin No.	100-ETA/ 100-ETB	700-RTC	700-PS
Type	Solid-state Timing Module (for 700-CF relays)	Solid-state Timing Relay	Solid-state Timer
Features	<ul style="list-style-type: none"> Changes all contacts on Bulletin 100-C contactors and Bulletin 700-CF control relays into timed contacts 	<ul style="list-style-type: none"> Timed and instantaneous contacts. Sealed contacts for harsh environments and hazardous locations. 	<ul style="list-style-type: none"> Self-contained or external potentiometer. Continuous carrying current of 5 A AC or DC. Stand alone or mount on Bulletin 700-P or 700-R.
Control Outputs: Time Limit Instantaneous	Four timed contacts on relay	Four output contacts	Three output contacts
Timing Operation Modes:	On-Delay Off-Delay	On-Delay Off-Delay	On-Delay Off-Delay
Time Range	0.1...180 s	0.05 s...64 min	0.1 ...120 s
Supply Voltage	110...240V 50/60 Hz 24V DC 110...250V DC	24V AC 110...120V AC 220...240V AC 24V DC 120V DC 240V DC	110...120V 50/60 Hz
Page Number	page 9-151	page 9-141	page 9-145

Bulletin No.	100-FPT	700-PT
Type	Pneumatic Timing Module (for Bulletin 700-CF relays)	Pneumatic Time-Delay Timer
Features	<ul style="list-style-type: none"> Timing function works independently of the supply voltage Relay contact operates instantaneously Continuous adjustment type 	<ul style="list-style-type: none"> Continuous carrying current of 10 A Contacts of N.O. and N.C. Open Type Without Enclosure Mounts on Bulletin 700-P relay
Control Outputs: Time Limit Instantaneous	Two timed contacts	One open, one closed
Timing Operation Modes:	On-Delay Off-Delay	On-Delay Off-Delay
Time Range	0.3...180 s	0.1...60 s
Supply Voltage	12...600V 50/60 Hz 12...250V DC	24...600V AC 6...600V DC
Page Number	page 9-151	page 9-115



700-P

Bulletin 700-P and 700-PK — Direct Drive™ Convertible Contact Cartridge Relays

- NEMA and IEC ratings
- 600V maximum AC/DC
- Accessories for field installation: Adder Decks, time delay, latching, surge suppressors, mounting strip
- Contact Ratings: (10 A) 700-CP1, (20 A) 700-CPM, (35 A) 700-CPH, (Low Power) 700-CPR
- For machine tool and other heavy-duty applications
- Can accommodate ring tongue terminals
- Integral DIN Rail adapter on AC relays
- Finger-safe protection standard

Table of Contents

Accessories 9-121
 Specifications 9-125
 Approximate Dimensions 9-127

Standards
 UL 508
 CSA C22.2, No. 14
 EN/IEC 60947-1, -5-1

Certifications
 cULus Listed (File No. E14840, Guide NKCR/NKCR7)
 ABS Certified

Description

The Bulletin 700-P family of relays has four types of contact cartridges to meet your specific switching requirements. Different cartridges can be combined into one relay to yield a custom-tailored application solution. Time delay, latching attachments, overlapping, and logic reed contacts are available.

Bulletin 700-P relays use standard (10 A) contact cartridges with a double-break and bifurcated design. Bifurcation provides excellent contact reliability and low-contact bounce, while the double-break contact design reduces the possibility of contacts welding and enhances the relay's ability to break DC circuits. These relays are supplied with a max. of 12 contacts (max. 8 N.C.).

Bulletin 700-PK master control relays contain (20 A) master contact cartridges with large single-contact pads on each side of the spanner for twice the current rating to control heavy loads and for master control of a system. The Bulletin 700-PK relay also has the same doublebreak design as the 700-P relay. These relays are supplied with a max. of 12 contacts (max. 8 N.C.). Time delay and latching attachments are available.

Bulletin 700-P and **-PK** relays combine the advantages of convertible contacts with **Direct Drive**, a construction designed to maintain non-overlap operation between N.O. and N.C. contacts (within published ratings).

Bulletin 700-PH relays contain (35 A) tandem contact cartridges. A jumper kit (Cat No. 700-CPH) allows two (20 A) master contact cartridges to be connected in parallel. A maximum of six poles are supplied, up to four of which can be normally closed. Time delay and latch attachments are available.

Electrically Held Relays

Bulletin 700-P Standard Contact Cartridge*❄

AC-Operated Relays

	Contacts		Contact Arrangement and Markings	Open Type Relay Rail Mount
	N.O.	N.C.		Cat. No.
	2	—	4-Pole Relay K1 A1X ‡ A2X A3X A4X ‡ K2 A1Y A2Y A3Y A4Y	700-P200❄
	4	—		700-P400❄
	6	—	8-Pole Relay B1X § B2X B3X B4X § B1Y B2Y B3Y B4Y	700-P600❄
	8	—		700-P800❄
	10	—	12-Pole Relay C1X * C2X C3X C4X * C1Y C2Y C3Y C4Y	700-P1000❄
	12	—		700-P1200❄

❄AC Coil Voltage Code

The Cat. No. as listed is incomplete. Select a voltage suffix code from the table below to complete the Cat. No. Example: **Cat. No. 700-P200❄** becomes **Cat. No. 700-P200A48**. For other coil voltages, consult your local Rockwell Automation sales office or Allen-Bradley distributor.

Hz	24	48	110	110-115	115-120	120	127	200-208	220-230	230-240	277	347	380	415	440-480	460-480	500	575-600
50	B24	B48	A1❄	B11 †	—	—	B27	—	B22	B2	—	—	B3	B41	B44	—	B50	—
60	A24	A48	—	—	A1❄	B11 †	—	A20	A22	A2	A27	A35	—	—	—	A4	—	A6

❄ Optimized for 115...120V, 60 Hz. Operates satisfactorily at 110V, 50 Hz. † Optimized for 110...115V, 50 Hz. Operates satisfactorily at 120V, 60 Hz.

‡ Location of contacts in 2-pole relays. § Location of contacts in 6-pole relays: 4-pole relay plus the two contacts indicated.

* Location of contacts in 10-pole relays: 8-pole relay plus the two contacts indicated.

* **Normally closed contacts:** The normally open contacts can easily be changed to normally closed in the field. Relays can be supplied with N.C. contacts.

❄ **Overlap contacts:** To order a relay containing one pair: Use **Cat. No. 700-PZ110**. To order a relay containing two pairs: Use **Cat. No. 700-PZ220**. N.O. contact closes before N.C. contact opens. AC Ratings: NEMA A600, DC Ratings: P161.

➤ See Accessories on page 9-123 for NEMA Type 1, Type 4/4X, and Type 7/9 enclosures available for field installation.

Bulletin 700-P
Heavy-Duty Industrial Relays
 Product Selection

DC-Operated Relays

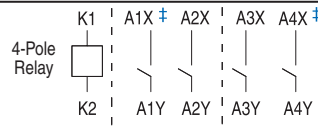
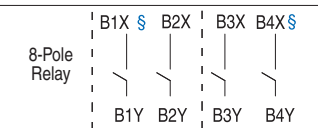
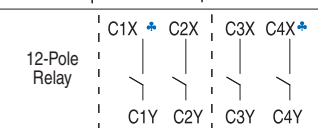
	Contacts		Contact Arrangement and Markings	Open Type Relay Rail Mount	Open Type DIN Rail Mount
	N.O.	N.C.		Cat. No.	Cat. No.
	2	—	4-Pole Relay 	700DC-P200®	700DC-P200D®
	4	—		700DC-P400®	700DC-P400D®
	6	—	8-Pole Relay 	700DC-P600®	700DC-P600D®
	8	—		700DC-P800®	700DC-P800D®
	10	—	12-Pole Relay 	700DC-P1000®	700DC-P1000D®
	12	—		700DC-P1200®	700DC-P1200D®

⊗DC Coil Voltage Code

The Cat. No. as listed is incomplete. Select a voltage suffix code from the table below to complete the Cat. No. Example: **Cat. No. 700DC-P200®** becomes **Cat. No. 700DC-P200Z48**. For other coil voltages, consult your local Rockwell Automation sales office or Allen-Bradley distributor.

6	12	18	24	32	48	64	72	90	115-125	230-250	500-550	575-600
Z06	Z12	Z18	Z24	Z32	Z48	Z64	Z72	Z90	Z1	Z2	Z5	Z6

Electrically Held Relays

Bulletin 700-PK Master Contact Cartridges*

AC-Operated Relays

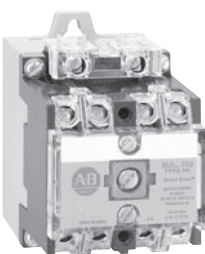
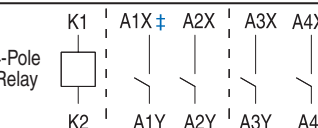
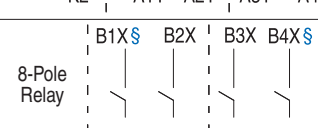
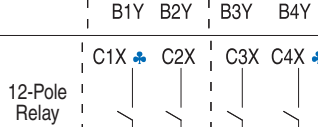
	Contacts		Contact Arrangement and Markings	Open Type Relay Rail Mount	Type 1 General Purpose
	N.O.	N.C.		Cat. No.	Cat. No.
	2	—	4-Pole Relay 	700-PK200®	700-PK201®
	4	—		700-PK400®	700-PK401®
	6	—	8-Pole Relay 	700-PK600®	700-PK601®
	8	—		700-PK800®	700-PK801®
	10	—	12-Pole Relay 	700-PK1000®	700-PK1001®
	12	—		700-PK1200®	700-PK1201®

⊗AC Coil Voltage Code

The Cat. No. as listed is incomplete. Select a voltage suffix code from the table below to complete the Cat. No. Example: **Cat. No. 700-PK200®** becomes **Cat. No. 700-PK200A48** for 48V 60 Hz. For other coil voltages, consult your local Rockwell Automation sales office or Allen-Bradley distributor.

Hz	24	48	110	110-115	115-120	120	127	200-208	220-230	230-240	277	347	380	415	440-480	460-480	500	575-600
50	B24	B48	A1%	B11+	—	—	B27	—	B22	B2	—	—	B3	B41	B44	—	B50	—
60	A24	A48	—	—	A1%	B11+	—	A20	A22	A2	A27	A35	—	—	—	A4	—	A6

% Optimized for 115...120V, 60 Hz. Operates satisfactorily at 110V, 50 Hz.

+ Optimized for 110...115V, 50 Hz. Operates satisfactorily at 120V, 60 Hz.

* **Normally closed contacts:** The normally open contacts can easily be changed to normally closed in the field. Relays can be supplied with N.C. contacts.

® **Overlap contacts:** To order a relay containing one pair: Use **Cat. No. 700-PZ110**. To order a relay containing two pairs: Use **Cat. No. 700-PZ2220**. N.O. contact closes before N.C. contact opens. AC Ratings: NEMA A600, DC Ratings: P161.

‡ Location of contacts in 2-pole relays.

§ Location of contacts in 6-pole relays: 4-pole relay plus the two contacts indicated.

♣ Location of contacts in 10-pole relays: 8-pole relay plus the two contacts indicated.

> See Accessories on page 9-123 for NEMA Type 1, Type 4/4X, and Type 7/9 enclosures available for field installation.

DC-Operated Relays

	Contacts		Contact Arrangement and Markings	Open Type Relay Rail Mount	Open Type DIN Rail Mount
	N.O.	N.O.		Cat. No.	Cat. No.
	2	—	4-Pole Relay 	700DC-PK200⊗	700DC-PK200D⊗
	4	—		700DC-PK400⊗	700DC-PK400D⊗
	6	—	8-Pole Relay 	700DC-PK600⊗	700DC-PK600D⊗
	8	—		700DC-PK800⊗	700DC-PK800D⊗
	10	—	12-Pole Relay 	700DC-PK1000⊗	700DC-PK1000D⊗
	12	—		700DC-PK1200⊗	700DC-PK1200D⊗

⊗DC Coil Voltage Code

The Cat. No. as listed is incomplete. Select a voltage suffix code from the table below to complete the Cat. No. Example: **Cat. No. 700DC-PK200⊗** becomes **Cat. No. 700DC-PK200Z12** for 12V DC. For other coil voltages, consult your local Rockwell Automation sales office or Allen-Bradley distributor.

6	12	18	24	32	48	64	72	90	115-125	230-250	500-550	575-600
Z06	Z12	Z18	Z24	Z32	Z48	Z64	Z72	Z90	Z1	Z2	Z5	Z6

⊗ Optimized for 115...120V, 60 Hz. Operates satisfactorily at 110V, 50 Hz.

‡ Optimized for 110...115V, 50 Hz. Operates satisfactorily at 120V, 60 Hz.

* **Normally closed contacts:** The normally open contacts can easily be changed to normally closed in the field. Relays can be supplied with N.C. contacts.

⊗ **Overlap contacts:** To order a relay containing one pair: Use **Cat. No. 700-PZ110**. To order a relay containing two pairs: Use **Cat. No. 700-PZ220**. N.O. contact closes before N.C. contact opens. AC Ratings: NEMA A600, DC Ratings: P161.

‡ Location of contacts in 2-pole relays.

§ Location of contacts in 6-pole relays: 4-pole relay plus the two contacts indicated.

♣ Location of contacts in 10-pole relays: 8-pole relay plus two contacts indicated

➤ See Accessories on page 9-123 for NEMA Type 1, Type 4/4X, and Type 7/9 enclosures available for field installation.

Electrically Held Relays — Typical Wiring Diagrams

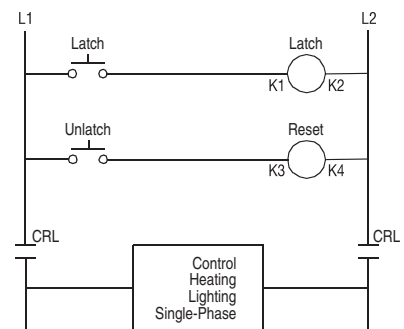
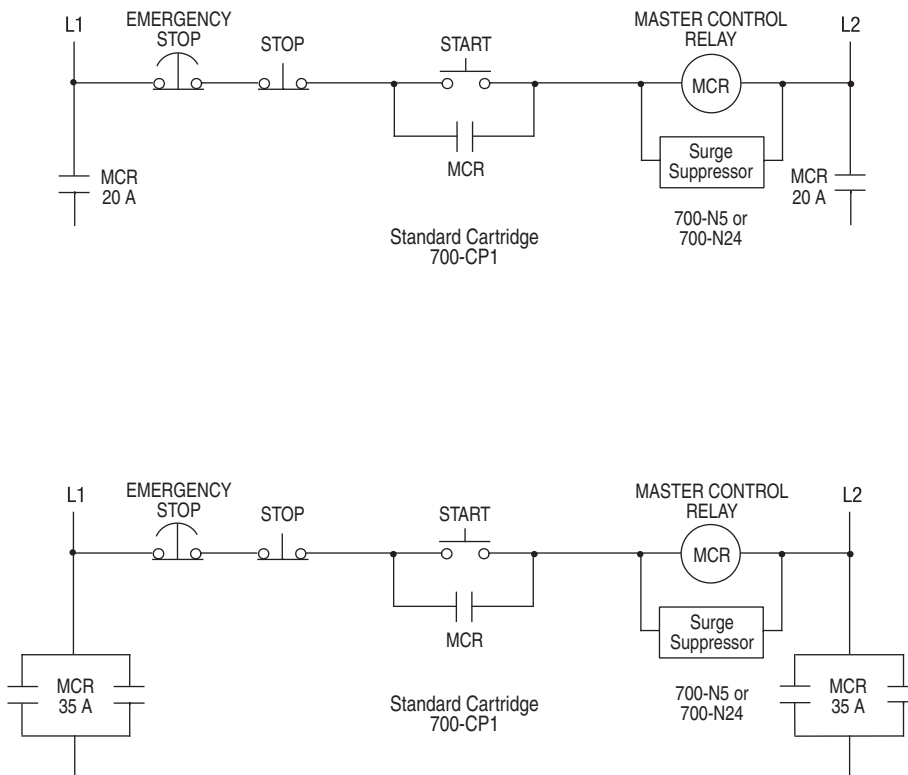

Heavy-Duty Industrial Relays

Product Selection

Electrically Held Relays

Bulletin 700-PH 35 A Tandem Contact Cartridges*

AC-Operated Relays

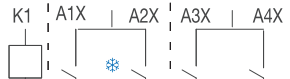
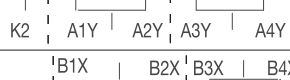
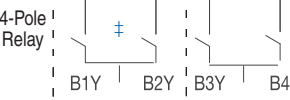
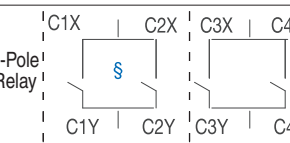

	Contacts		Contact Arrangement and Markings	Open Type Relay Rail Mount➤
	N.O.	N.C.		Cat. No.
 <p>Cat. No. 700-PH200</p>	1	—		700-PH100⊗
	2	—		700-PH200⊗
	3	—	 <p>4-Pole Relay</p>	700-PH300⊗
	4	—		700-PH400⊗
	5	—	 <p>6-Pole Relay</p>	700-PH500⊗
	6	—		700-PH600⊗

⊗AC Coil Voltage Code

The Cat. No. as listed is incomplete. Select a voltage suffix code from the table below to complete the Cat. No. Example: **Cat. No. 700-PH100⊗** becomes **Cat. No. 700-PH100A48**. For other coil voltages, consult your local Rockwell Automation sales office or Allen-Bradley distributor.

Hz	24	48	110	110-115	115-120	120	127	200-208	220-230	230-240	277	347	380	415	440-480	460-480	500	575-600
50	B24	B48	A1%	B11+	—	—	B27	—	B22	B2	—	—	B3	B41	B44	—	B50	—
60	A24	A48	—	—	A1%	B11+	—	A20	A22	A2	A27	A35	—	—	—	A4	—	A6

DC-Operated Relays

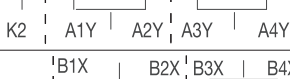
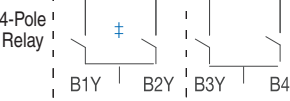
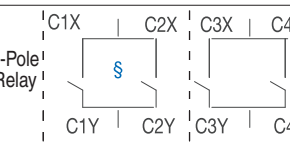
	Contacts		Contact Arrangement and Markings	Open Type Relay Rail Mount➤	Open Type DIN Rail Mount➤
	N.O.	N.C.		Cat. No.	Cat. No.
 <p>Cat. No. 700DC-PH200</p>	1	—		700DC-PH100⊗	700DC-PH100D⊗
	2	—		700DC-PH200⊗	700DC-PH200D⊗
	3	—	 <p>4-Pole Relay</p>	700DC-PH300⊗	700DC-PH300D⊗
	4	—		700DC-PH400⊗	700DC-PH400D⊗
	5	—	 <p>6-Pole Relay</p>	700DC-PH500⊗	700DC-PH500D⊗
	6	—		700DC-PH600⊗	700DC-PH600D⊗

⊗DC Coil Voltage Code

The Cat. No. as listed is incomplete. Select a voltage suffix code from the table below to complete the Cat. No. Example: **Cat. No. 700DC-PH200⊗** becomes **Cat. No. 700DC-PH200Z12**. For other coil voltages, consult your local Rockwell Automation sales office or Allen-Bradley distributor.

6	12	18	24	32	48	64	72	90	115-125	230-250	500-550	575-600
Z06	Z12	Z18	Z24	Z32	Z48	Z64	Z72	Z90	Z1	Z2	Z5	Z6

% Optimized for 115...120V, 60 Hz. Operates satisfactorily at 110V, 50 Hz.

+ Optimized for 110...115V, 50 Hz. Operates satisfactorily at 120V, 60 Hz.

* **Normally closed contacts:** The normally open contacts can easily be changed to normally closed in the field. Relays can be supplied with N.C. contacts.

* Location of contacts in 1-pole relays.

‡ Location of contacts in 3-pole relays: 2-pole relay plus the contact indicated.

§ Location of contacts in 5-pole relays: 4-pole relay plus the contact indicated.

➤ See Accessories on page 9-123 for NEMA Type 1, Type 4/4X, and Type 7/9 enclosures available for field installation.





Time Delay Relays — Open Type With Pneumatic Time-Delay Attachment

- Factory-Assembled Bulletin 700-PT and PKT Timing Relays
 - Timing Range — 0.1...60 s
 - 0, 2, or 4 instantaneous contacts
 - Two timed contacts — both ON Delay or both OFF Delay
 - Convertible from ON Delay to OFF Delay and vice versa
 - Standard contact cartridges rated NEMA A600 (AC) and P600 (DC)
 - Master contact cartridges rated 2X NEMA A600 (AC) and 2X P600 (DC)

Bulletin 700-P Standard Contact Cartridge*❄

AC-Operated Relays			DC-Operated Relays			
Contacts		Contact Arrangement and Markings	Open Type Relay Rail Mount	Contact Arrangement and Markings	Open Type Relay Rail Mount	Open Type DIN Rail Mount
N.O.	N.C.		Cat. No.		Cat. No.	Cat. No.
0	—	Relay with only time delay contacts	700-PPT ❄	Relay with only time delay contacts	700DC-PPT	700DC-PPTD
2	—		700-PT200 ❄		700DC-PT200	700DC-PT200D
4	—		700-PT400 ❄		700DC-PT400	700DC-PT400D

Bulletin 700-PK Master Contact Cartridges*

AC-Operated Relays			DC-Operated Relays			
Contacts		Contact Arrangement	Open Type Relay Rail Mount	Contact Arrangement	Open Type Relay Rail Mount	Open Type DIN Rail Mount
N.O.	N.C.		Cat. No.		Cat. No.	Cat. No.
0	—	Relay with only time delay contacts	700-PPKT	Relay with only time delay contacts	700DC-PPKT	700DC-PPKTD
2	—		700-PKT200		700DC-PKT200	700DC-PKT200D
4	—		700-PKT400		700DC-PKT400	700DC-PKT400D

⊗AC Coil Voltage Code

The Cat. No. as listed is incomplete. Select a voltage suffix code from the table below to complete the Cat. No. Example: **Cat. No. 700-PKT200** becomes **Cat. No. 700-PKT200A48** for 48V 60 Hz. For other coil voltages, consult your local Rockwell Automation sales office or Allen-Bradley distributor.

Hz	24	48	110	110-115	115-120	120	127	200-208	220-230	230-240	277	347	380	415	440-480	460-480	500	575-600
50	B24	B48	A1 ❄	B11+	—	—	B27	—	B22	B2	—	—	B3	B41	B44	—	B50	—
60	A24	A48	—	—	A1 ❄	B11+	—	A20	A22	A2	A27	A35	—	—	—	A4	—	A6

❄ Optimized for 115...120V, 60 Hz. Operates satisfactorily at 110V, 50 Hz.

† Optimized for 110...115V, 50 Hz. Operates satisfactorily at 120V, 60 Hz.

⊗DC Coil Voltage Code

The Cat. No. as listed is incomplete. Select a voltage suffix code from the table below to complete the Cat. No. Example: **Cat. No. 700DC-PKT200** becomes **Cat. No. 700DC-PKT200Z12** for 12V DC. For other coil voltages, consult your local Rockwell Automation sales office or Allen-Bradley distributor.

6	12	18	24	32	48	64	72	90	115-125	230-250	500-550	575-600
Z06	Z12	Z18	Z24	Z32	Z48	Z64	Z72	Z90	Z1	Z2	Z5	Z6

* **Normally closed contacts:** The normally open contacts can easily be changed to normally closed in the field. Relays can be supplied with N.C. contacts.

❄ **Overlap contacts:** N.O. contact closes before N.C. contact opens. To order a relay containing one pair: Use **Cat. No. 700-PTZ110**. To order a relay containing two pairs: Use **Cat. No. 700-PTZ2220**. AC Ratings: NEMA A600, DC Ratings: P161.

‡ Location of contacts in 2-pole relays.

* Timer has 1 N.O. and 1 N.C. convertible cartridge in addition to the instantaneous cartridges on the relay. Timer is supplied as On-Delay. Convertible to Off-Delay in the field.

➤ The timer has 1 N.O. and 1 N.C convertible master cartridge in addition to the instantaneous master cartridges on the relay. Timer is supplied as On-Delay. It is convertible to Off-Delay in the field.

Heavy-Duty Industrial Relays

Product Selection



Mechanical Latching Relays

- Factory-Assembled Bulletin 700-PL Latching Relays
- Converts all poles to latching
- AC latch coil — max. six poles latching
- DC latch coil — max. five poles latching
- Latching relays have two coils — latch coil is the relay coil, reset coil is on the latch attachment
- Latch/reset coils can have two AC coils, two DC coils, or one AC and one DC coil (e.g., latch with AC power, unlatch with DC battery)

Bulletin 700-P Standard Contact Cartridge*❄

AC-Operated Relays			DC-Operated Relays		
Contacts		Contact Arrangement and Markings	Open Type Relay Rail Mount with Mechanical Latch Attachment (Read ATTENTION Below)	Contact Arrangement and Markings	
N.O.	N.C.			Cat. No.	Cat. No.
0	—	—	—	—	—
2	—	<p>6-Pole Relay</p>	700-PL200❄	<p>5-Pole Relay</p>	700DC-PL200❄
4	—		700-PL400❄		700DC-PL400❄
6	—		700-PL600❄		700DC-PL500❄

❄AC Coil Voltage Code

The Cat. No. as listed is incomplete. Select a voltage suffix code from the table below to complete the Cat. No. Example: **Cat. No. 700-PL200❄** becomes **Cat. No. 700-PL200A48**. For other coil voltages, consult your local Rockwell Automation sales office or Allen-Bradley distributor.

Relays with latch attachments: if the latch attachment coil is to be a different voltage other than the relay coil, add a second coil code suffix. Example: **Cat. No. 700-PL400A1A24**. Only one suffix is required if both coils are the same voltage.

Hz	24	48	110	110-115	115-120	120	127	200-208	220-230	230-240	277	347	380	415	440-480	460-480	500	575-600
50	B24	B48	A1❄	B11+	—	—	B27	—	B22	B2	—	—	B3	B41	B44	—	B50	—
60	A24	A48	—	—	A1❄	B11+	—	A20	A22	A2	A27	A35	—	—	A4	—	A6	—

❄ Optimized for 115...120V, 60 Hz. Operates satisfactorily at 110V, 50 Hz.

+

❄DC Coil Voltage Code

The Cat. No. as listed is incomplete. Select a voltage suffix code from the table below to complete the Cat. No. Example: **Cat. No. 700DC-PL200❄** becomes **Cat. No. 700DC-PL200Z12**. For other coil voltages, consult your local Rockwell Automation sales office or Allen-Bradley distributor.

6	12	18	24	32	48	64	72	90	115-125	230-250	500-550	575-600
Z06	Z12	Z18	Z24	Z32	Z48	Z64	Z72	Z90	Z1	Z2	Z5	Z6

ATTENTION – An open or failed unlatch control circuit will fail to unlatch the relay. For this reason, a mechanical latch unit should not be used where protection is needed against automatic restart after a power failure or where reliability to a control function is critical to safety.

* **Normally closed contacts:** The normally open contacts can easily be changed to normally closed in the field. Relays can be supplied with N.C. contacts.

❄ **Overlap contacts:** To order a relay containing one pair: Use **Cat. No. 700-PTZ110**. To order a relay containing two pairs: Use **Cat. No. 700-PTZ2220**. N.O. contact closes before N.C. contact opens. AC Ratings: NEMA A600, DC Ratings: P161.

‡ Location of contacts in 2-pole relays.



§ Location of contacts in 4-pole relays: 2-pole relay plus the 2 contacts indicated.

Accessories





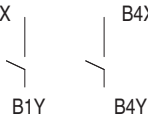
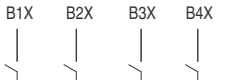

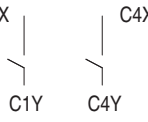
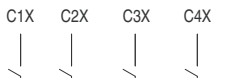



International Symbol for Mechanically Linked Contacts



Adder Decks

Image	Description	No. of N.O. Contacts	No. of N.C. Contacts	Continuous Carrying Current [A]	Arrangement	Cat. No.
						Cat. No.
 Second Deck Cat. No. 700-PB40	Second Deck (2-pole)	2	—	10	B1X B4X  B1Y B4Y	700-PB20
		2	—	20		700-PKB20
	Second Deck (4-pole)	4	—	10	B1X B2X B3X B4X  B1Y B2Y B3Y B4Y	700-PB40
		4	—	20		700-PKB40
 Third Deck Cat. No. 700-PC40	Third Deck (2-pole)	2	—	10	C1X C4X  C1Y C4Y	700-PC20
		2	—	20		700-PKC20
	Third Deck (4-pole)	4	—	10	C1X C2X C3X C4X  C1Y C2Y C3Y C4Y	700-PC40
		4	—	20		700-PKC40

Contact Cartridges (Convertible from N.O. to N.C. and N.C. to N.O.)

Image	Description		Continuous Carrying Current[A]	Arrangement	Pkg. Quantity	Cat. No.
 Standard Contact Cartridge Cat. No. 700-CP1, -CP11Z	Standard Contact Cartridge AC Rating NEMA A600 DC Rating NEMA P600		10		1	700-CP1
	Overlap Contact Cartridges Overlapping Used in pairs. N.O. contact closes before N.C. contact opens on pick-up and vice versa on drop-out.*		10			2
 Master Contact Cartridge Cat. No. 700-CPM	Master Contact Cartridge AC Rating Twice NEMA A600 DC Rating Twice NEMA P600		20			1
	Logic Reed Cartridge for Low Energy Circuits 150V AC 500 mA 25 VA Max. 30V DC 200 mA 6W Max.*		500 mA			1
 Logic Reed Cartridge Cat. No. 700-CPR	Maximum 150V AC		200 mA			1
	Maximum 30V DC					
 Safety Contact Cartridge Cat. No. 700-CMS	Safety Contact Cartridge Cartridge meeting IEC 947-5 Note: Use this cartridge when full compliance to IEC 947-5 is required. 700-P relays equipped with CPS cartridges fully meet the IEC 947-5 spec for mechanically linked contacts.		10		1	700-CPS
			20			700-CMS

* Not Direct Drive.

* The 700-CPR Logic Reed cartridge must be installed only in the 2nd deck (B1X - B4X, B1Y - B4Y position) or 3rd deck (C1X - C4X, C1Y - C4Y position) of the Bulletin 700 Type P relay. It is not recommended that the 700-CPR cartridge be installed in the single deck (A1X - A4X, A1Y - A4Y position) because this may lead to improper operation.

Bulletin 700-P
Heavy-Duty Industrial Relays
 Product Selection

Bulletin 700-PS and -PSR Solid-State Timers*

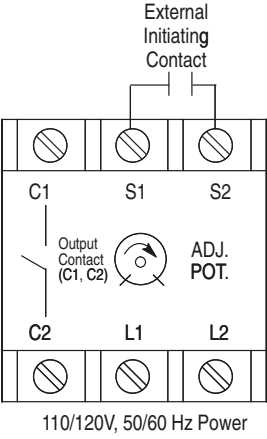
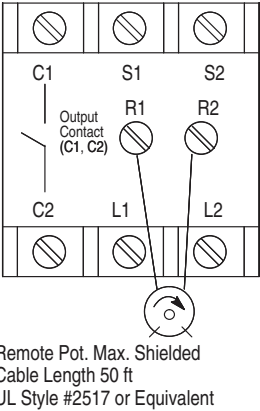
	Description	Continuous Carrying Current [A]	Arrangement	Timing Range*	Cat. No.		
	Self-Contained Potentiometer On-Delay	5	 <p>External Initiating Contact</p> <p>110/120V, 50/60 Hz Power</p>	0.1...2	700-PSAA1		
				0.4...8	700-PSBA1		
	Off-Delay			1.5...30	700-PSCA1		
				6...120	700-PSDA1		
				0.1...2	700-PSPA1		
				0.4...8	700-PSRA1		
				1.5...30	700-PSSTA1		
				6...120	700-PSUA1		
	External Potentiometer On-Delay			5	 <p>Remote Pot. Max. Shielded Cable Length 50 ft UL Style #2517 or Equivalent</p>	0.1...2 s	700-PSRAA1
						0.4...8 s	700-PSRBA1
1.5...30 s		700-PSRCA1					
6...120 s		700-PSRDA1					
0.1...2 s		700-PSRPA1					
0.4...8 s		700-PSRRA1					
1.5...30 s		700-PSRTA1					
6...120 s		700-PSRUA1					

Remote Potentiometers for Cat. No. 700-PSR...

Timing Range [s]	Resistance [mΩ]	Cat. No.
0.1...2	0.75	700-N35
0.4...8	0.75	700-N35
1.5...30	2.0	700-N36
6...120	3.5	700-N37

Pneumatic Time-Delay Unit – 1 N.O. and 1 N.C. Convertible Contact Cartridge*

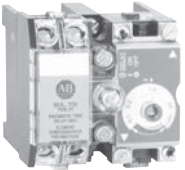
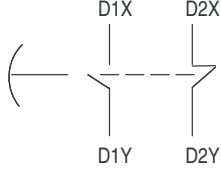
 Pneumatic Time-Delay	Description			Continuous Carrying Current [A]	Arrangement	Timing Range	Open Type Without Enclosure
	Operating Mode	No. of N.O. Contacts	No. of N.C. Contacts				Cat. No.
On-Delay Off-Delay	1	1	10		0.1...60 s	700-PT	
			20			700-PKT	

* Mounts on 4-pole Bulletin 700-P or -PK relay or 2-pole Bulletin 700-PH relay.

* Maximum time may be 50% greater and the minimum time may be 50% less than the value specified.

Mechanical Latch Units

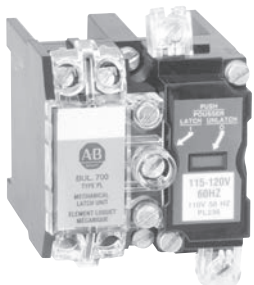
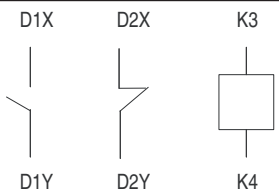
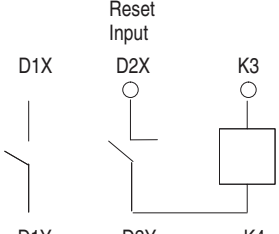
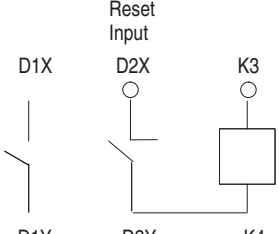
	Description	Arrangement	Continuous Carrying Current [A]	Cat. No.
	AC-Operated Latch Units		No cartridge	700-PLL [⊗]
			10	700-PLL11 [⊗]
			20	700-PKLL11 [⊗]
			DC-Operated Latch Units	
			10	700DC-PLL10 [⊗]
			20	700DC-PKLL10 [⊗]

⊗AC Coil Voltage Code

The Cat. No. as listed is incomplete. Select a voltage suffix code from the table below to complete the Cat. No. Example: **Cat. No. 700-PLL[⊗]** becomes **Cat. No. 700-PLLA1**. For other coil voltages, consult your local Rockwell Automation sales office or Allen-Bradley distributor.





Hz	24	48	110	110-115	115-120	120	127	200-208	220-230	230-240	277	347	380	415	440-480	460-480	500	575-600
50	B24	B48	A1*	B11*	—	—	B27	—	B22	B2	—	—	B3	B41	B44	—	B50	—
60	A24	A48	—	—	A1*	B11*	—	A20	A22	A2	A27	A35	—	—	—	A4	—	A6

* Optimized for 115...120V, 60 Hz. Operates satisfactorily at 110V, 50 Hz.
 * Optimized for 110...115V, 50 Hz. Operates satisfactorily at 120V, 60 Hz.

⊗DC Coil Voltage Code









The Cat. No. as listed is incomplete. Select a voltage suffix code from the table below to complete the Cat. No. Example: **Cat. No. 700DC-PLL[⊗]** becomes **Cat. No. 700DC-PLLZ12**. For other coil voltages, consult your local Rockwell Automation sales office or Allen-Bradley distributor.

6	12	18	24	32	48	64	72	90	115-125	230-250	500-550	575-600
Z06	Z12	Z18	Z24	Z32	Z48	Z64	Z72	Z90	Z1	Z2	Z5	Z6

	Description	Relays per Strip	Pkg. Quantity	Cat. No.
 <p>Mounting Strip Cat. No. 700-MP4</p>	Relay Rail Simplifies panel layout. These indexed strips are easily cut to the required length and bolted, riveted, or spot-welded in place. Relays are installed adjacent to one another on the mounting strip with the captive mounting screws provided. Rows of relays on Relay Rail form their own wiring trough. Can be used with the following relays: 700P, 700-PK, 700PH, 700S-P, 700N, 700-R, 700-RTC	4	5	700-MP4
		8	5	700-MP8
		12	5	700-MP12
		16	5	700-MP16
 <p>Cat. No. 700-DRA</p>	DIN Rail Adapter Can be used with the following relays: Bulletin 700P, 700-PK, 700-PH, 700S-P, 700-N, 700-R, 700-RTC		1	700-DRA
 <p>199-DR1</p>	DIN (#3) symmetrical hat rail 35 x 7.5 x 1 m		10	199-DR1
 <p>Cat. No. 700-N31</p>	Type 1 Enclosure — Use for all Bulletin 700-P, -PH, and -PK relays except 10- and 12-pole DC relays or 5- and 6-pole DC Bulletin 700-PH relays.		1	700-N31
	Type 4/4X Enclosure — For 2- and 4-pole Bulletin 700-P, -PH, -N, and -R relays and 2-pole Bulletin 700-PH relays.		1	700-N39
	Type 7 & 9 Enclosure — For 2- and 4-pole Bulletin 700-P, -PK, -N, and -R relays and 2-pole Bulletin 700-PH relays. 1 conduit hub; top and bottom.		1	700-N33

Heavy-Duty Industrial Relays

Accessories

	Description	Pkg. Quantity	Cat. No.	
 <p>Surge Suppressor Cat. No. 700-N5</p>				
		Mounting behind relay	1	700-N5
 <p>Surge Suppressor Cat. No. 700-N24</p>	<p>Surge Suppressors (RC Circuit) — Surge suppressors reduce the high transient voltages generated when the coil circuit is opened. These suppressors can be used with Bulletin 700-P, -PH, -PK, and -N relays, and other electromechanical devices. They contain a resistor and capacitor. Maximum ratings: 150V, AC or DC, 35 VA. Cat. No. 700-N5 requires 1 in. additional depth of enclosure.</p>	Mounting on coil terminal	1	700-N24
 <p>Surge Suppressor Cat. No. 199-FSMA1</p>	<p>Surge Suppressor When the circuit to a DC operating coil is opened, the inductive energy stored in the coil can generate very high transient voltages. With the addition of the appropriate surge suppressor, the stored energy is absorbed and dissipated limiting the voltage spikes. A surge suppressor is not required with AC 700-R or -RM relays because the AC operating coil transients are suppressed by a full wave rectifier connected to the coil.</p>	24...48V AC/DC	1	199-FSMA9
		50...120V AC/DC	1	199-FSMA10
		130...250V AC/DC	1	199-FSMA11
	<p>Diode Surge Suppressor — for 6...300V DC voltage coils. Used on Bulletin 700-P, -PH, -PK, -N, -F, and -R relays.</p>		1	199-FSMZ-1
 <p>35 A Jumper Kit Cat. No. 700-CPH</p>	<p>35 A Jumper Kit – CSA Approved, UL Listed This 35 A Jumper Kit can be used with any Bulletin 700-P and -PK AC or DC relay, Time-Delay relay or Latch Unit equipped with 20 A Master Cartridges. It does not require any additional panel space. Jumper Kit terminals are designed for one #8 AWG wire or two #10 AWG wires. When connecting the two 20 A Master Cartridges in parallel, it is important that they be the same configuration (Normally Open or Normally Closed). Jumpers can be added to any contact cartridge location on a relay except the two center poles because of the wide spacing. An adhesive label is included with each kit listing the contact ratings.</p>		1	700-CPH
 <p>Jumper Cat. No. 700-N3</p>	<p>Jumpers (Not applicable for Bulletin 700-PH or -PK relays) – For connection between a middle pole and an outer pole on the left or right side of the relay.</p>	<p>Jumper – For outer poles</p>	<p>50</p>	700-N3
				 <p>Jumper Cat. No. 700-N4</p>
 <p>Check Out Tool Cat. No. 700-N23</p>	<p>Check Out Tool — Mechanically maintains the Bulletin 700-P, -PH, or -PK relay in the energized position for troubleshooting purposes.</p>		1	700-N23
	<p>Adapter Plate — Simplified relay conversion. Allows you to use the existing mounting holes when you replace a Bulletin 700-B, -BR, -BX, or -D relay with a Bulletin 700-P, -PH, or -PK relay.</p>			700-N34
 <p>Protective Cover — For 700-PT Timing Adjustment Knob. Helps prevent tampering with time setting.</p>			5	700-N38

IP 2x Finger-Safe Cover Accessories

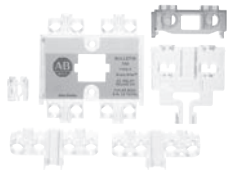
	Description	Pkg. Quantity	Cat. No.
	Top Covers (Covering Top Level Contact Screws)		
	IP2X Top Cover for 700-P, (AC Standard Relays)	5	700-PFSACT
	IP2X Top Cover for 700-P, (DC Standard Relays)	5	700-PFSDCT
	IP2X Top Cover for 700PK, (AC Master Control Relays)	5	700-PFSAPKT
	IP2X Top Cover for 700PK, (DC Master Control Relays)	5	700-PFSDPKT
	Timer Top Cover Kit, (for Relays with Pneumatic Latch Attachment)	5	700-PFSTC
	Timer Top Cover Kit (for Relays with Mechanical Latch Attachment)	5	700-PFSLCK
	Timer Top Cover Kit, (for Master Cont. Relays with Pneumatic Timer)	5	700-PFSKTC
	Latch Top Cover Kit (for Master Cont. Relays with Mechanical Latch)	5	700-PFSKLC
	Deck Covers (Covering all terminals not on top deck, only for multi-deck relays)		
IP2X Deck Cover for all AC & DC Relays in the 700P Range	10	700-PFSDEK	
Coil Covers			
IP2X Coil Cover for all AC Relays in the 700P Range	5	700-PFSACC	
IP2X Coil Cover for all DC Relays in the 700P Range	5	700-PFSDCC	



Type		700-P, PL, PT						700-PK, PKL, PKT						700-PH							
Electrical																					
Contact Rating Continuous		10 A @ 600V AC 5 A @ 600V DC						20 A @ 600V AC 10 A @ 600V DC						35 A @ 600V AC 20 A @ 600V DC							
Ratings Make/Break	AC	NEMA A600						2 x NEMA A600						2 x NEMA A600							
	DC	NEMA P600						2 x NEMA P600						2 x NEMA P600							
Additional Contact Ratings for AC single-phase loads		—						3 Hp @ 240V AC - N.O. 2 Hp @ 240V AC - N.O./N.C. 1 Hp @ 120V AC - N.O./N.C. 20 A Resistive Heating to 600V AC 20 A Tungsten Lighting Load to 480V AC						5 Hp @ 240V AC - N.O. 3 Hp @ 240V AC - N.O./N.C. 2 Hp @ 120V AC - N.O./N.C. 35 A General Use At 0.75 PF to 600V AC 35 A Tungsten Lighting Load to 480V AC							
DC Current Ratings Make/Break		Cartridge Cat. No. 700-CP1						Cartridge Cat. No. 700-CPM						Cartridge Cat. No. 700-CPH							
DC Switching		Volts DC																			
		Contacts in Series	24	64	125	250	500	600	24	64	125	250	500	600	24	64	125	250	500	600	
			5 A	2.2 A	1.1 A	.55 A	.24 A	.2 A	10 A	5 A	2.2 A	.55 A	.24 A	.2 A	10 A	5 A	2.2 A	.55 A	.24 A	.2 A	
		1	5 A	2.2 A	1.1 A	.55 A	.24 A	.2 A	10 A	5 A	2.2 A	.55 A	.24 A	.2 A	10 A	5 A	2.2 A	.55 A	.24 A	.2 A	
		2	10 A	10 A	5 A	2 A	.7 A	.5 A	20 A	10 A	5 A	2 A	.7 A	.5 A	20 A	10 A	5 A	2 A	.7 A	.5 A	
		3	—	—	7 A	3 A	1.5 A	1.0 A	—	15 A	7 A	3 A	1.5 A	1.0 A	—	15 A	7 A	3 A	1.5 A	1.0 A	
		4	—	—	10 A	5 A	2.5 A	1.5 A	—	20 A	10 A	5 A	2.5 A	1.5 A	—	20 A	10 A	5 A	2.5 A	1.5 A	
Coil Voltage Range		AC	85...110%						85...110%						85...110%						
		DC	80...110%						80...110%						80...110%						
		Battery Charging	85...115%						85...115%						85...115%						
Coil Consumption P-PH-PK		A	50 Hz			60 Hz			50 Hz			60 Hz			50 Hz			60 Hz			
			Inrush	132VA*			138VA*			132VA*			138VA*			132VA*			138VA*		
		C	Sealed	19.3VA*			19VA*			19.3 VA*			19VA*			19.3VA*			19VA*		
			D	12.7VA*						12.7VA*						12.7VA*					
		C	12.7VA*						12.7VA*						12.7VA*						
PLL - PKLL AC Latch Unit		Inrush	15VA*			15.6VA*			5VA*			15.6VA*			15VA*			15.6VA*			
		Sealed	5.4VA*			5.5VA*			5.4VA*			5.5VA*			5.4VA*			5.5VA*			
PLL - PKLL DC Latch Unit		Unlatch	35VA*						35VA*						—						
		Intermittent	35 W*						35 W*						—						
Reset Time		PT - PKT	75 ms						75 ms						—						
Minimum Pulse		PLL-PKLL	75 ms						75 ms						—						
Mechanical																					
Operating Time		Pickup	AC - 10...20 ms DC - 30...50 ms						AC - 10...20 ms DC - 30...50 ms						AC - 10...20 ms DC - 30...50 ms						
		Dropout	AC - 10...20 ms DC - 20...33 ms						AC - 10...20 ms DC - 20...33 ms						AC - 10...20 ms DC - 20...33 ms						
Mechanical Life		10 million operations																			
Construction																					
Contact Arrangement		Up to 12 Poles, Convertible to N.O. or N.C. (8 N.C. Maximum)						Up to 12 Poles, Convertible to N.O. or N.C. (8 N.C. Maximum)						Up to 6 Poles, Convertible to N.O. or N.C. (4 N.C. Maximum)							
Contact Material		Nickel Silver						Silver Cadmium Oxide						Silver Cadmium Oxide							
Mounting		Panel or Strip Mount Horizontal Mounting Recommended						Panel or Strip Mount Horizontal Mounting Recommended						Panel or Strip Mount Horizontal Mounting Recommended							
Environmental																					
Temperature		Operating*	-20...+65 °C (-4...149 °F)						-20...+65 °C (-4...149 °F)						-20...+65 °C (-4...149 °F)						
		Storage	-40...+65 °C (-40...149 °F)						-40...+65 °C (-40...149 °F)						-40...+65 °C (-40...149 °F)						
Certifications		CSA Certified, CSA File #LR1234, UL Listed, UL File #E14840, Guide NKCR, CE Certified, ABS																			
Standards		UL 508, CSA C22.2 No. 14, EN/IEC 60947-1, -5-1																			
Wire Terminations																					
Wire size per UL/CSA		#18 AWG...(2) #12 AWG																			
Tightening Torque		8...12 lb•in (0.9...1.4 N•m)																			

* Temperature inside the panel.



* Average value for all coils within range. For values on a specific coil voltage, contact your local Rockwell Automation sales office or Allen-Bradley distributor.

Heavy-Duty Industrial Relays

Specifications

Operating Coils

Bulletin 700 Bulletin 700-P-PH-PK Relays — Bulletin 700-PLL-PKLL Mechanical Latch Attachments*

	Coil Volts*	Bulletin 700-P, -PK 2...12-pole, Bulletin 700-PH 1...6-pole AC		Bulletin 700-PLL-PKLL AC Mechanical Latch Attachment		Bulletin 700-P-PK 2...12-pole, Bulletin 700-PH 1...6-pole DC
		60 Hz	50 Hz	60 Hz	50 Hz	
 Bulletin 700-P Operating Coil	24	PA013	PA407	PL013	PL407	PD714
	32	—	—	—	—	PD718
	48	PA222	PA314	PL222	PL314	PD724
	110*	—	PA236	—	PL236	PD733 § (100...110)
	115...120*	PA236	—	PL236	—	—
	110...115‡	—	PA322	—	PL322	—
	115...125	—	—	—	—	PD735
 Bulletin 700-PL Unlatch Coil and Magnet Assembly	120‡	PA322	—	PL322	—	—
	130...140	—	—	—	—	PD738
	200...208	PA249	—	PL249	—	—
	220...230	PA251	PA339	—	PL339	—
	230...240	PA254	PA342	PL254	PL342	—
	230...250	—	—	PD748	—	PD748
	277	PA260	—	—	—	—
	380	—	PA354	—	PL354	—
	415	—	PA357	—	PL357	—
	440...460	—	PA360	—	PL360	—
	460...480	PA273	—	PL273	—	—
	500	—	PA364	—	PL364	PD759
	575...600	PA278	—	PL278	—	PD758

* Coils for AC relays cannot be used in DC relays and vice versa.

* This coil is optimized for 115...120V, 60 Hz applications and will operate satisfactorily at 110V, 50 Hz.

‡ This coil is optimized for 110...115V, 50 Hz applications and will operate satisfactorily at 120V, 60 Hz.

§ This coil is designed and marked for use at 100...110V DC.

Dimensions are shown in millimeters (inches). Dimensions are not intended to be used for manufacturing purposes.

Bulletin 700-P, -PH and -PK Relays

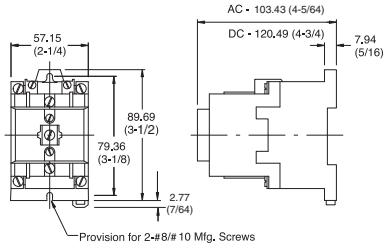

2- and 4-pole Bulletin 700-P, -PK Relay — 2-pole Bulletin 700-PH Relay
 Approximate Shipping Weight: AC – 0.68 kg (1.5 lb), DC – 1.34 kg (2.95 lb)

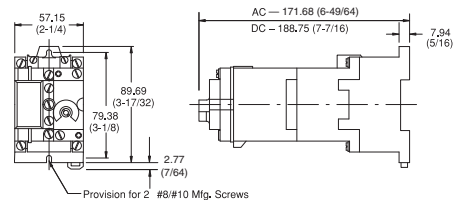

2- and 4-pole Bulletin 700-P or -PK Relay or 2-pole Bulletin 700-PH Relay with Pneumatic Time Delay Attachment
 Approximate Shipping Weight: AC – 0.85 kg (1.88 lb), DC – 1.5 kg (3.33 lb)

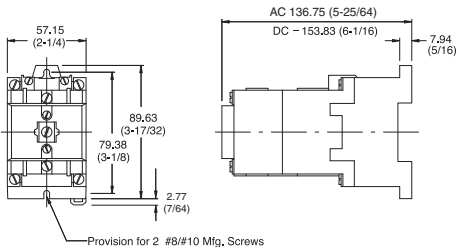

6- and 8-pole Bulletin 700-P, or -PK Relay — 4-pole Bulletin 700-PH Relay Approximate Shipping Weight:
 AC – 0.79 kg (1.75 lb), DC – 1.45 kg (3.20 lb)

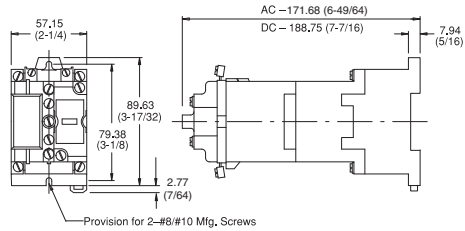

2- and 4-pole Bulletin 700-P or -PK Relay or 2-pole Bulletin 700-PH Relay with Mechanical Latch Attachment Approximate Shipping Weight:
 AC – 0.97 kg (2.13 lb), DC – 1.62 kg (3.58 lb)

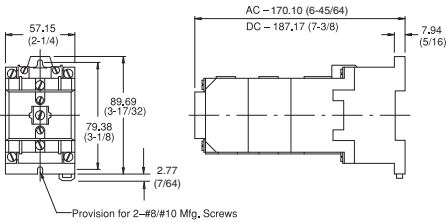

10- and 12-pole Bulletin 700-P, DIN Rail Adapter or -PK Relay — 6-pole Bulletin 700-PH Relay
 Approximate Shipping Weight: AC – 1.02 kg (2.25 lb), DC – 1.68 kg (3.7 lb)

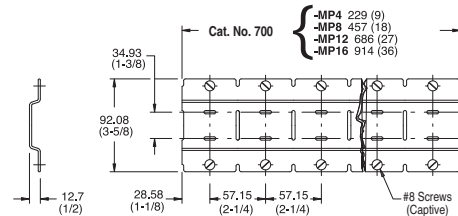

Relay Rail for Bulletin 700-P, -PH, -PK, -N, -NM, -R, -RM, -RT, -RTA Relays
 Secure the mounting strip with two screws at each end relay position. Use a minimum of one screw at the 3rd, 5th, 7th, etc., relay positions. Alternate between upper and lower horizontal slots.

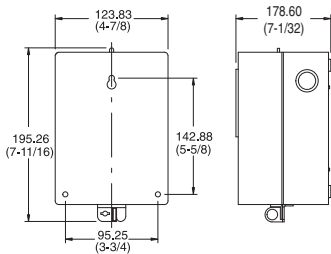

Cat. No. 700-N31, Type 1 Enclosure for Bulletin 700-P, -PH, -PK, -RTC Relays
 Approximate Shipping Weight: 1.26 kg (2.8 lb)

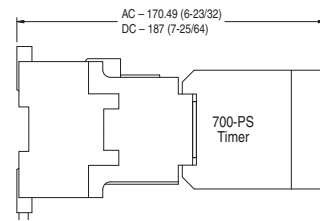

Bulletin 700-PS Timer Mounted on a 4-pole Bulletin 700-P or -PK Relay or 2-pole Bulletin 700-PH Relay
 Approximate Shipping Weight: AC – 0.68 kg (1.5 lb) without 700-PS, eDC – 1.34 kg (2.9 lb) without 700-PS

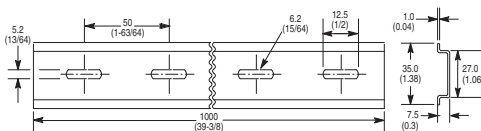

Cat. No. 199-DR1 DIN Mounting Rail Series B
 Cat. No. 199-DR4 DIN Mounting Rail Series B Has No Mounting Holes

DIN Rail Adapter

Heavy-Duty Industrial Safety Relays

Overview/Product Selection



Bulletin 700S-P/700S-PK — Heavy-Duty Safety Control Relays

Features

- Mechanically linked contacts meet IEC 947-5-1-L
- 2...12 poles – all mechanically linked
- Red cover for easy identification of safety circuits
- Tamper resistant cover helps prevent changes which could jeopardize safety
- IEC mechanically linked contacts symbol displayed on front
- Visual indication of contact state
- Ideal for use in safety circuits

Table of Contents

Specifications..... 9-129
 Approximate Dimensions..... 9-130

Certifications

cULus Listed (File No. E14840, Guide NKCR/NKCR7)
 CE Certified
 ABS Certified

Standards Compliance

UL 508
 CSA C22.2 No. 14

Product Selection

Bulletin 700S-P (10 A) Safety Control Relays — AC and DC Coil Voltages

Contacts		AC Coils		24V DC Coils	
		Open Type Panel Mount Relay Rail Mount	Open Type Panel Mount Relay Rail Mount	Open Type Panel Mount Relay Rail Mount	Open Type DIN Rail Mount
N.O.	N.C.	Cat. No.*	Cat. No.*	Cat. No.*	Cat. No.*
3	1	700S-P310⊗	700S-DCP310Z24	700S-DCP310DZ24	700S-DCP310DZ24
2	2	700S-P220⊗	700S-DCP220Z24	700S-DCP220DZ24	700S-DCP220DZ24
7	1	700S-P710⊗	700S-DCP710Z24	700S-DCP710DZ24	700S-DCP710DZ24
6	2	700S-P620⊗	700S-DCP620Z24	700S-DCP620DZ24	700S-DCP620DZ24
5	3	700S-P530⊗	700S-DCP530Z24	700S-DCP530DZ24	700S-DCP530DZ24
4	4	700S-P440⊗	700S-DCP440Z24	700S-DCP440DZ24	700S-DCP440DZ24
3	5	700S-P350⊗	700S-DCP350Z24	700S-DCP350DZ24	700S-DCP350DZ24
10	2	700S-P1020⊗	700S-DCP1020Z24	700S-DCP1020DZ24	700S-DCP1020DZ24

⊗AC Coil Voltage Code

The Cat. No. as listed is incomplete. Select a coil voltage code from the table below to complete the Cat. No.

Example: **Cat. No. 700S-P310** becomes **Cat. No. 700S-P310A1** for a 120V AC coil.

[V]	24	115-120	230-240	460-480
60 Hz	A24	A1	A2	A4

* For other coil voltages, consult your local Rockwell Automation sales office or Allen-Bradley distributor.

IEC 947-5-1 Annex L has 2 requirements for a relay to meet for mechanically linked contacts:

- 1.) If a N.O. contact welds, all the N.C. contacts will remain open and meet a 2500V impulse test.
- 2.) If a N.C. contact welds, all the N.O. contacts will remain open and meet a 2500V impulse test.

Bul. Nos. 700S-P and 700S-DCP relays meet these requirements including the 2500V impulse test.

The relays shown on this page are shipped from the factory with the Bul. 700-CPS safety cartridge installed and cannot be converted to N.O. or N.C. in the Field.

Bulletin 700S-PK (20 A) Safety Control Relays

Contacts		Coil Voltage	Cat. No.
N.O.	N.C.		
7	1	110V AC	700S-PK710A1
6	2	110V AC	700S-PK620A1
5	3	110V AC	700S-PK530A1
4	4	110V AC	700S-PK440A1
3	5	110V AC	700S-PK350A1
10	2	110V AC	700S-PK1020A1
3	1	110V AC	700S-PK310A1
7	1	24V DC	700S-DCPK710Z24
6	2	24V DC	700S-DCPK620Z24
5	3	24V DC	700S-DCPK530Z24
4	4	24V DC	700S-DCPK440Z24
3	5	24V DC	700S-DCPK350Z24
10	2	24V DC	700S-DCPK1020Z24
3	1	24V DC	700S-DCPK310Z24



Heavy-Duty Industrial Safety Relays

Specifications

Type		700S-P						
Electrical								
Contact Rating Continuous		10 A @ 600V AC 5 A @ 600V DC						
Ratings Make/Break	AC	NEMA A600						
	DC	NEMA P600						
Minimum Contact Switching Ratings		10V, 50 mA						
DC Switching	Contacts in Series	Volts DC						
		24V	64V	125V	250V	500V	600V	
	1	5 A	2.2 A	1.1 A	0.55 A	0.24 A	0.2 A	
	2	10 A	10 A	5 A	2 A	0.7 A	0.5 A	
	3	—	—	7 A	3 A	1.5 A	1.0 A	
4	—	—	10 A	5 A	2.5 A	1.5 A		
Contact Electrical Life—Resistive Loads		1.5 million operations at 10A break at 120V AC 14 million operations at 1A break at 120V AC 6 million operations at 1A break at 24V DC						
Coil Voltage Range*	AC	85...110%						
	DC	80...110%						
	Battery Charging	85...115%						
Coil Consumption		50 Hz			60 Hz			
AC	Inrush	132 VA			138 VA			
	Sealed	19.3 VA			19 VA			
DC	Inrush	12.7 W						
	Sealed	12.7 W						
Mechanical								
Mechanically Linked Contacts		All contacts are mechanically linked per IEC 947-5-1 annex L for 2 to 12 poles						
Operating Time	Pickup	AC – 10...20 ms DC – 30...50 ms						
	Dropout	AC – 10...20 ms DC – 20...33 ms						
Mechanical Life		10 million operations						
Construction								
Contact Arrangement		2 to 12 Poles, Double Break Contacts N.O. or N.C. (8 N.C. Maximum)						
Contact Material/Design		Silver Nickel/Bifurcated						
Mounting		Panel mount or mount on 700-MP Relay or DIN Rail Horizontal Mounting Recommended						
Environmental								
Operating Temperature‡		-20...+65 °C (-4...+149 °F)						
Storage Temperature		-40...+65 °C (-40...+149 °F)						
Wire Terminations								
Wire size per UL/CSA		#18 AWG...(2) #12 AWG						
Tightening Torque		8...12 lb•in (0.9...1.4 N•m)						

* Coil voltage required for proper operation (percent of rated coil voltage).

‡ Temperature inside the panel.

Type		700S-PK						
Electrical								
Contact Rating Continuous		20 A @ 600V AC 10 A @ 600V DC						
Ratings Make/Break	AC	NEMA A600						
	DC	NEMA P600						
Additional Contact Ratings for AC Single-Phase Loss		3 Hp @ 240V AC - N.O. 2 Hp @ 240V AC - N.O./N.C. 1 HP @ 120V AC - N.O./N.C. 20 A resistive heating to 600V AC 20 A Tungsten lighting load to 480V AC						
DC Current Ratings Make/Break		Cartridge Cat. No. 700-CMS						
DC Switching	Contacts in Series	Volts DC						
		24V	64V	125V	250V	500V	600V	
	1	10 A	5 A	2.2 A	0.55 A	0.24 A	0.2 A	
	2	20 A	10 A	5 A	2 A	0.7 A	0.5 A	
	3	—	15 A	7 A	3 A	1.5 A	1.0 A	
4	—	20 A	10 A	5 A	2.5 A	1.5 A		
Coil Voltage Range*	AC	85...110%						
	DC	80...110%						
	Battery Charging	85...115%						
Coil Consumption		50 Hz			60 Hz			
AC	Inrush	132 VA			138 VA			
	Sealed	19.3 VA			19 VA			
DC	Inrush	12.7 W						
	Sealed	12.7 W						
Mechanical								
Mechanically Linked Contacts		All contacts are mechanically linked per IEC 947-5-1 annex L for 2 to 12 poles						
Operating Time	Pickup	AC – 10...20 ms DC – 30...50 ms						
	Dropout	AC – 10...20 ms DC – 20...33 ms						
Construction								
Contact Arrangement		2 to 12 Poles, Convertible to N.O. or N.C. (8 N.C. Maximum)						
Contact Material/Design		Silver Cadmium Oxide						
Mechanical (Mechanically-Linked Contacts)		All contacts, are mechanically linked per IEC 947-5-1 Annex L for 2 to 12 poles						
Mounting		Panel mount or strip mount recommended						
Environmental								
Operating‡ Temperature		-20...+65 °C (-4...+149 °F)						
		-40...+65 °C (-40...+149 °F)						
Wire Terminations		CSA certified, CSA file #LR1234, UL listed, UL file #E14840, Guide NKCR, CE certified IEC 947-5-1, IEC 336-1 CENELEC, BS 4794, VDE 0660, Listed: U.S. Coast Guard and American Bureau of Shipping, UL 508, CSA22.2						
		Wire size per UL/CSA		#18 AWG...(2) #12 AWG				
Tightening Torque		8...12 lb•in (0.9...1.4 N•m)						

* Coil voltage required for proper operation (percent of rated coil voltage).

‡ Temperature inside the panel.

Bulletin 700S-P
Heavy-Duty Industrial Safety Relays
 Approximate Dimensions

Dimensions are shown in millimeters (inches). Dimensions are not intended for manufacturing purposes.

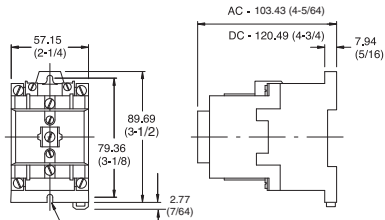

Provision for 2-#8/#10 Mfg. Screws
2- and 4-pole Bulletin 700S-P Relay

Approximate Shipping Weight: AC - 0.68 kg (1.5 lb), DC - 1.34 kg (2.95 lb)

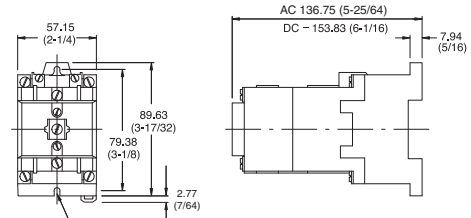

Provision for 2 #8/#10 Mfg. Screws
6- and 8-pole Bulletin 700S-P Relay

Approximate Shipping Weight: AC - 0.79 kg (1.75 lb), DC - 1.45 kg (3.20 lb)

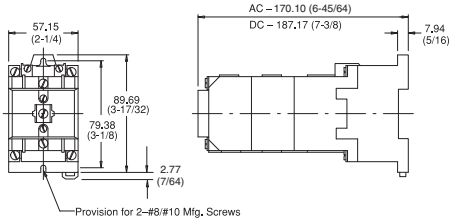

Provision for 2-#8/#10 Mfg. Screws
10- and 12-pole Bulletin 700S-P

Approximate Shipping Weight: AC - 1.02 kg (2.25 lb), DC - 1.68 kg (3.7 lb)

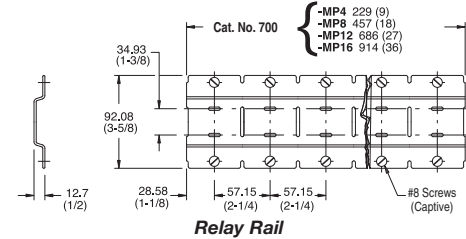

Relay Rail

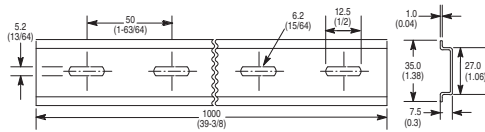

DIN Rail

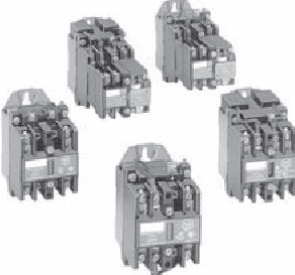
	<p>Bulletin 700-N — Industrial Relay</p> <ul style="list-style-type: none"> • Contact cartridges convertible from N.O. to N.C. and vice versa • NEMA A300 AC • 24...250V AC coils • Pneumatic timing unit • Solid-state timing unit • Overlap contacts • Logic reed contacts • 4-...8-pole 	<p>Table of Contents</p> <p>Product Selection this page</p> <p>Accessories..... 9-133</p> <p>Specifications..... 9-138</p> <p>Approximate Dimensions..... 9-135</p> <p>Standards Compliance and Certifications</p> <p>cULus Listed (File No. E14840, Guide NKCR/NKCR7) per UL 508</p> <p>CSA C22.2 No. 14</p>
---	---	---

AC-Operated Relays

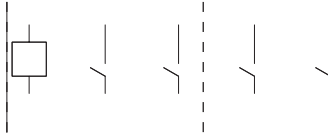
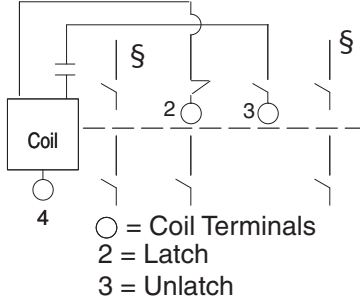
	Contacts* ❄		Contact Arrangement	Open Type
	N.O.	N.C.		Cat. No.
	4	—	4-Pole Relay 	700-N400❄
Type NM Relay 2 Poles ‡	2	—	 <p>○ = Coil Terminals 2 = Latch 3 = Unlatch</p>	700-NM200❄

❄ **AC Coil Voltage Code**

The Cat. No. as listed is incomplete. Select a coil voltage code from the table below to complete the cat. no. Example: **Cat. No. 700-N200❄** becomes **Cat. No. 700-N200A24** for 24V 60 Hz. For other coil voltages, contact your local Rockwell Automation sales office or Allen-Bradley distributor.

[V]	24	110	120	208	220	240
50 Hz	—	A1	—	—	A2	—
60 Hz	A24	—	A1	A20	—	A2

* **NORMALLY CLOSED CONTACTS:** Listed relays are supplied with all contacts normally open. These contacts can be readily converted to normally closed in the field.

❄ **OVERLAP CONTACTS:** Overlap contacts (normally open contact closes before the normally closed contact opens) can be supplied. See page 9-133 for information on kits for field installation of overlap contact cartridges.

§ Location of contacts in 2-pole relays

‡ Permanent Magnet Latch AC Relay. Minimum Operating Time - Type NM - For reliable operation, power to the latch circuit **must be** maintained for a minimum time of 75 milliseconds and power to the unlatch circuit **must be** maintained for minimum time of 50 milliseconds.

Operating Coils

 <p>Bulletin 700-N Operating Coil</p>	Bulletin 700-N Relay • 2-...8-Pole		
	Coil Voltage	60 Hz	50 Hz
	24	84AB27	84AB28
	110	84AB01	84AB86
	120	84AB86	—
	208	84AB113	—
	220	84AB06	84AB83
	240	84AB83	—

Bulletin 700-NT Pneumatic Timing Unit

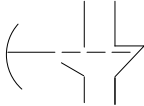
 Cat. No. 700-NT	Description Timing Unit Only (for Bulletin 700-N, 2...4-pole)	Timed Contacts		Contact Arrangement 	Open Type Cat. No. 700-NT
		N.O.	N.C.		
		1	1	ON-Delay mode is standard. Timer is easily converted to OFF-Delay mode.	











Bulletin 852S Solid-State Timing Unit for Mounting on Bulletin 700-N Relays*

(Supplied as On-Delay. Easily Converted to Off-Delay Mode) Input: 110V/50 Hz, 120V/60 Hz; Output: NEMA B300, Sealed Contacts

Timing Unit with Self-Contained Potentiometer		
Minimum Time [s]	Minimum Time [s]	Cat. No.
0.1	5.0	852S-NSA
0.5	30.0	852S-NSB
1.0	60.0	852S-NSC

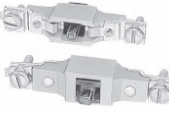
Timing Unit Only			External Potentiometer	
Minimum Time [s]	Maximum Time [s]	Cat. No.	Resistance	Cat. No.
0.1	0.21	* 852S-A*	15 kΩ	800T-U34
	0.35		25 kΩ	800T-U37
	0.70		50 kΩ	800T-U41
	1.10		75 kΩ	800T-U46
	1.50		100 kΩ	800T-U49
	2.10		150 kΩ	800T-U50
	5.6		400 kΩ	800T-U54
	7.0		500 kΩ	800T-U55
	14.0		1 MΩ	800T-U57
	29.0		2 MΩ	800T-U59
1.0	2.0	852S-C	50 kΩ	800T-U41
	4.0		100 kΩ	800T-U49
	8.0		200 kΩ	800T-U51
	16.0		400 kΩ	800T-U54
	32.0		800 kΩ	800T-U56
	40.0		1 MΩ	800T-U57
	80.0		2 MΩ	800T-U59
	120.0		3 MΩ	800T-U62
	160.0		4 MΩ	800T-U64

* The maximum time is fixed by component characteristics and may be up to 70% greater than listed
 * These timing relays require an external potentiometer. To order an external potentiometer, refer to right side of table.

	Description		Cat. No.
 Universal Mounting Strip	Relay Rail Simplifies panel layout. These indexed strips are easily cut to the required length and bolted, riveted, or spot-welded in place. Relays are installed adjacent to one another on the mounting strip with the captive mounting screws provided. Rows of relays on Relay Rail form their own wiring trough. Can be used with the following relays: 700P, 700-PK, 700PH, 700S-P, 700N, 700-R, 700-RTC	Relays per strip 4 8 12 16	700-MP4 700-MP8 700-MP12 700-MP16
 Cat. No. 700-DRA	DIN Rail Adapter	—	700-DRA
 Cat. No. 700-NA00	Front Deck Front decks can be attached to Bulletin 700 4-pole relays. Provides up to 4 additional convertible poles – without changing the mounting area.	Front Deck without Contact Cartridges	700-NA00
 Cat. No. 700-NA00	Standard Contact Cartridges Available for adding to both rear deck and front deck.	Rear Deck Contact Cartridge Front Deck Contact Cartridge	* 700-C1 * 700-C2
 Cat. No. 700-NA00	Gold-Plated Contact Cartridges May be used in low power circuits to improve reliability. Good for long term storage, because gold resists corrosion.	Rear Deck Contact Cartridge Front Deck Contact Cartridge	* 700-C1X * 700-C2X
 Cat. No. 700-NA00	Logic Reed Cartridges Cartridges are hermetically sealed contact for low energy switching.	Rear Deck Contact Cartridge (150V AC, 150 mA, 8VA Max.) (30V DC, 60 mA Max.)	* 700-C1R
 Cat. No. 700-NA00	Bifurcated Contact Cartridges Cartridges are less apt to open because of vibration and shock.	Rear Deck Contact Cartridge Front Deck Contact Cartridge	* 700-C1B * 700-C2B
 Cat. No. 700-C11Z	Overlap Contact Cartridges Cartridges are available in pairs. The N.O. contact closes before the N.C. contact opens. 300V AC max. 125V DC max.	Rear Deck Contact Cartridge (1 pair in a package) Front Deck Contact Cartridge (1 pair in a package)	* 700-C11Z * 700-C22Z
Timing Unit Replacement (Bifurcated) Contact Cartridge for Bulletin 700-NT relay		Timing Unit Deck Contact Cartridge	* X-457011
 Cat. No. 700-N4,-N3	Jumpers (Not applicable for Bulletin 700-PH or -PK relays) – For connection between a middle pole and an outer pole on the left or right side of the relay.	Jumper for middle pole to outer poles Jumper for middle poles	700-N3 700-N4
Gold-Plated Contact Timing Unit Replacement Cartridge		—	* 40163-447-03
 Cat. No. 700-N5 Cat. No. 700-N24	Surge Suppressors (RC Circuit) — Surge suppressors reduce the high transient voltages generated when the coil circuit is opened. These suppressors can be used with Bulletin 700-P, -PH, -PK, and -N relays, and other electromechanical devices. They contain a resistor and capacitor. Maximum ratings: 150V, AC or DC, 35 VA. Cat. No. 700-N5 requires 1 in. additional depth of enclosure.	For mounting behind relay (1 in. additional depth needed) For mounting on coil terminal	700-N5 700-N24
 Cat. No. 700-N21	Check Out Tool Mechanically maintains the Bulletin 700-N relay in operated position.	Check Out Tool for Bulletin 700-N AC relay	700-N21

* All contact cartridges are convertible (N.O. or N.C.).

Bulletin 700-N
Industrial Relays
Specifications

		Bul. 700-N	Bul. 700-NT
Electrical Ratings			
Rated Thermal Current I_{th}		10 A	
Rated Insulation Voltage		300V	
Contact Rating		10 A @ 300V AC, NEMA A300	
Coil Voltage Range	AC	85...110%	—
	DC	80...110%	—
Coil Consumption			
AC		50 Hz	60 Hz
	Inrush	120 VA	133 VA
	Sealed	24 VA	20 VA
Mechanical			
		AC	—
Max. Operating Time	Pickup	14 ms	—
	Drop Out	13 ms	—
Timing Range		—	0.2...60 s
Repeat Accuracy		—	±15% of setting
Reset Time		—	75 ms
Timing Mode		—	On-Delay — convertible to OFF Delay, up to 2 poles convertible to N.O. or N.C.
Construction			
Contact Arrangement		Up to 8 Poles, Convertible to N.O. or N.C.	—
Contact Material		Silver	Silver
Mounting		Panel or strip mount Horizontal mounting recommended	On relay only
Environmental			
Ambient Temperature (Outside Enclosure)	Operating	-20...+40 °C (-4...+104 °F)	
	Storage	-40...+60 °C (-40...+140 °F)	
Operating Temperature Rise (Inside Enclosure)		+25 °C Max	—
Wire Terminations			
Wire size per UL/CSA		#18 AWG...(2) #12 AWG	
Tightening Torque		8...12 lb•in. (0.9...1.4 N•m)	

Approximate Dimensions

Dimensions are shown in millimeters (inches). Dimensions are not intended to be used for manufacturing purposes.

Type of Relay	No. of Poles	Drawing Number	Open Type Without Enclosure				Approx. Ship. Wt. kg (lbs.)	Type 1 General Purpose Enclosure					Approx. Ship. Wt. kg (lbs.)	
			A Wide	B High	C Deep	D		A Wide	B High	C Deep	D	E		
N	Bulletin 700	2...4	1	57.15 (2-1/4)	88.90 (3-1/2)	82.55 (3-1/4)	79.38 (3-1/8)	0.68 (1-1/2)	107.95 (4-1/4)	185.74 (7-5/16)	103.19 (4-1/16)	146.05 (5-3/4)	85.73 (3-3/8)	1.59 (3-1/2)
	Bulletin 700	6...8	2	57.15 (2-1/4)	88.90 (3-1/2)	106.36 (4-3/16)	79.38 (3-1/8)	0.79 (1-3/4)	112.71 (4-7/16)	228.60 (9)	120.65 (4-3/4)	206.38 (8-1/8)	92.08 (3-5/8)	2.27 (5)
N with Pneumatic Timer	Bulletin 700	2...4	3	57.15 (2-1/4)	88.90 (3-1/2)	138.11 (5-7/16)	79.38 (3-1/8)	0.91 (2)	—	—	—	—	—	—
N with Solid-State Timer	Bulletin 700	2...4	3	57.15 (2-1/4)	88.90 (3-1/2)	160.34 (6-5/16)	79.38 (3-1/8)	1.02 (2-1/4)	—	—	—	—	—	—

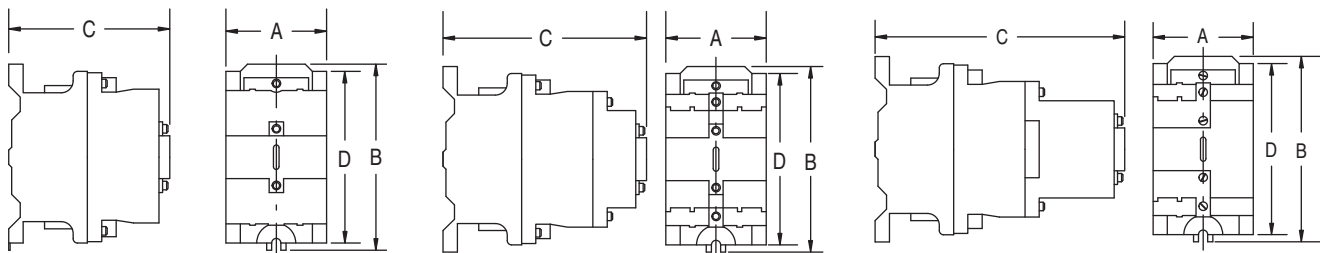

Drawing Number 1

Drawing Number 2

Drawing Number 3

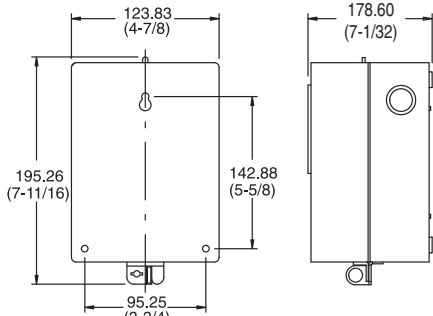

Type 1 Enclosure

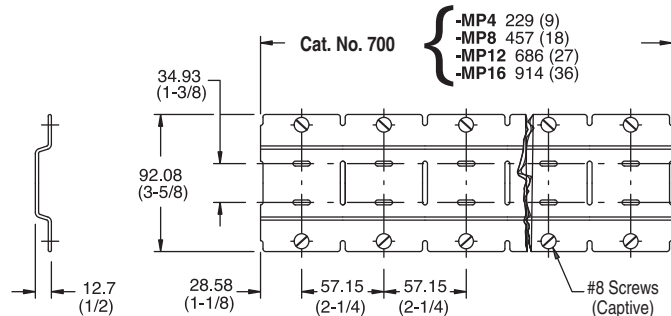

Relay Rail for Bulletin 700-P, -PH, -PK, -N, -NM, -R, -RM, -RT, -RTA Relays

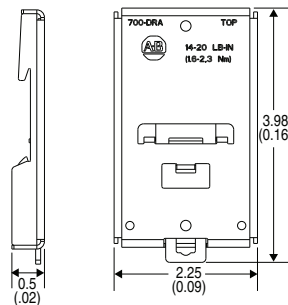
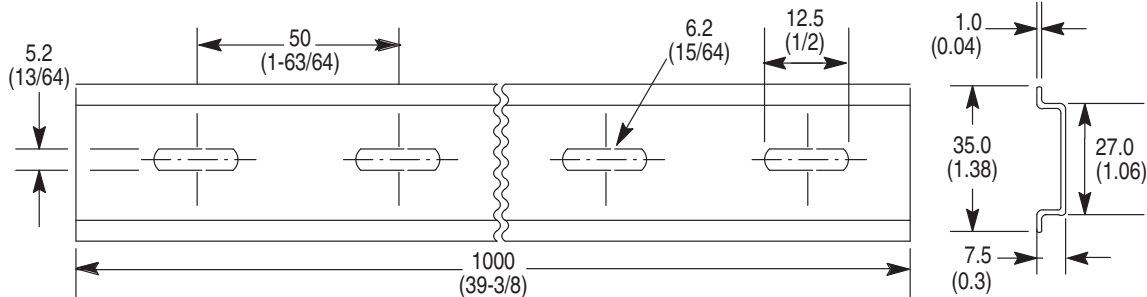

DIN Rail Adapter

Sealed Switch Relays

Product Overview/Product Selection

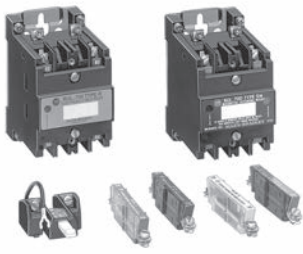
	<p>Bulletin 700-R, -RM — Sealed Switch Relays</p> <ul style="list-style-type: none"> • Sealed contacts • Extremely long mechanical and electrical life • Hazardous locations Class 1, Div 2 Groups A, B, C, D • Harsh environments • Suitable for applications with shock and vibration • High reliability circuit integrity 	<p>Table of Contents</p> <p>Product Selection 9-137</p> <p>Specifications..... 9-139</p> <p>Approximate Dimensions..... 9-140</p> <p>Standards Compliance and Certifications</p> <ul style="list-style-type: none"> • UL Listed (File No. E10314) (Guide No. NOIV) per UL 508 • CSA Certified (File No. LR11924) • CE Certified
---	---	--

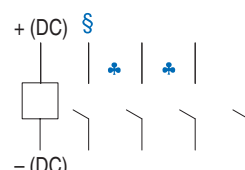
No. of Poles	Contacts		Electrically Held Contact Arrangement and Markings*	AC-Operated Relay Only	DC-Operated Relay Only
	N.O.	N.C.		Open Type	Open Type
				Cat. No.	Cat. No.
0	0	0	Relay without Contact	700-R000⊗	700DC-R000⊗
2	2	0		700-R200⊗	700DC-R200⊗
	1	1		700-R110⊗	700DC-R110⊗
	0	2		700-R020⊗	700DC-R020⊗
4	4	0		700-R400⊗	700DC-R400⊗
	3	1		700-R310⊗	700DC-R310⊗
	2	2		700-R220⊗	700DC-R220⊗
	1	3		700-R130⊗	700DC-R130⊗
6	0	4		700-R040⊗	700DC-R040⊗
	6	0		700-R600⊗	700DC-R600⊗
	5	1		700-R510⊗	700DC-R510⊗
	4	2	700-R420⊗	700DC-R420⊗	
	3	3	700-R330⊗	700DC-R330⊗	
	2	4	700-R240⊗	700DC-R240⊗	
	1	5	700-R150⊗	700DC-R150⊗	
8	0	6	700-R060⊗	700DC-R060⊗	
	8	0	700-R800⊗	700DC-R800⊗	
	7	1	700-R710⊗	700DC-R710⊗	
	6	2	700-R620⊗	700DC-R620⊗	
	5	3	700-R530⊗	700DC-R530⊗	
	4	4	700-R440⊗	700DC-R440⊗	
	3	5	700-R350⊗	700DC-R350⊗	
	2	6	700-R260⊗	700DC-R260⊗	
	1	7	700-R170⊗	700DC-R170⊗	
0	8	700-R080⊗	700DC-R080⊗		

⊗ **Coil Voltage Code**

The Cat. No. as listed is incomplete. Select a voltage code from the table below to complete the Cat. No. Example: **Cat. No. 700-R000⊗** becomes **Cat. No. 700-R000A24**. For other coil voltages, contact your local Rockwell Automation sales office or Allen-Bradley distributor.

Type of Relay	[V]	Coil Volts							
		24	48	110	115-125	120	220	230-250	240
AC	25 Hz	—	—	C11	—	C1	—	—	C2
	50 Hz	B24	B48	A1	—	—	A2	—	—
	60 Hz	A24	A48	—	—	A1	—	—	A2
DC	—	Z24	Z48	—	Z1	—	—	Z2	—

- * Arrangement displays all N.O. contacts.
- § Polarity must be observed for DC voltage (700 DC) relays.
- ♣ Location of contacts in 2-pole relays.
- > Location of contacts in 6-pole relays.



No. of Poles	Contacts		Contact Arrangement and Markings *	AC-Operated Relay Only	DC-Operated Relay Only
	N.O.	N.C.		Open Type	Open Type
				Cat. No.	Cat. No.
0	0	0	Relay without Contact	700-RM000⊗	700DC-RM000⊗
2	2	0		700-RM200⊗	700DC-RM200⊗
	1	1		700-RM110⊗	700DC-RM110⊗
	0	2		700-RM020⊗	700DC-RM020⊗
4	4	0		700-RM400⊗	700DC-RM400⊗
	3	1		700-RM310⊗	700DC-RM310⊗
	2	2		700-RM220⊗	700DC-RM220⊗
	1	3		700-RM130⊗	700DC-RM130⊗
	0	4		700-RM040⊗	700DC-RM040⊗
6	6	0		700-RM600⊗	700DC-RM600⊗
	5	1		700-RM510⊗	700DC-RM510⊗
	4	2		700-RM420⊗	700DC-RM420⊗
	3	3		700-RM330⊗	700DC-RM330⊗
	2	4		700-RM240⊗	700DC-RM240⊗
	1	5		700-RM150⊗	700DC-RM150⊗
8	8	0		700-RM800⊗	700DC-RM800⊗
	7	1		700-RM710⊗	700DC-RM710⊗
	6	2		700-RM620⊗	700DC-RM620⊗
	5	3		700-RM530⊗	700DC-RM530⊗
	4	4		700-RM440⊗	700DC-RM440⊗
	3	5		700-RM350⊗	700DC-RM350⊗
	2	6		700-RM260⊗	700DC-RM260⊗
	1	7		700-RM170⊗	700DC-RM170⊗
	0	8		700-RM080⊗	700DC-RM080⊗

⊗ **Coil Voltage Code**

The Cat. No. as listed is incomplete. Select a voltage code from the table below to complete the Cat. No. Example: **Cat. No. 700-RM000⊗** becomes **Cat. No. 700-RM000A24**. For other coil voltages, contact your local Rockwell Automation sales office or Allen-Bradley distributor.

Type of Relay	[V]	Coil Volts							
		24	48	110	115-125	120	220	230-250	240
AC	25 Hz	—	—	C11	—	C1	—	—	C2
	50 Hz	B24	B48	A1	—	—	A2	—	—
	60 Hz	A24	A48	—	—	A1	—	—	A2
DC	—	Z24	Z48	—	Z1	—	—	Z2	—

- * Arrangement displays all N.O. contacts.
- § Location of contacts in 6-pole relays.
- ♣ Polarity must be observed for DC voltage (700 DC) relays.
- Location of contacts in 2-pole relays.

Modifications

Description	Letter Designation	Manual Actuator Addition for Relay	Actuation Qty.
Manual Actuator A factory-installed manual actuator is available for manual energization of the relay coils. To order, replace the letters "R" or "RM" after the dash in the listed catalog number with the letters listed at right. Ratings 150V AC or DC maximum. Example: Cat. No. 700-RM300A1 becomes Cat. No. 700-RMLR300A1 .	RL	Type R	1
	RML	Type RM on Latch Coil	1
	RMR	Type RM on Reset Coil	1
	RMLR	Type RM on Latch and Reset Coil (2 manual actuators supplied)	2

Bulletin 700-R, -RM
Sealed Switch Relays
 Accessories

Accessories for Bulletin 700-R, -RM Relays

		Bul. 700-N	Bul. 700-NT
Electrical Ratings			
Rated Thermal Current I^n		10 A	
Rated Insulation Voltage		300V	
Contact Rating		10 A @ 300V AC, NEMA A300	
Coil Voltage Range	AC	85...110%	—
	DC	80...110%	—
Coil Consumption			
		50 Hz	60 Hz
AC	Inrush	120 VA	133 VA
	Sealed	24 VA	20 VA
Mechanical			
		AC	—
Max. Operating Time	Pickup	14 ms	—
	Drop Out	13 ms	—
Timing Range		—	0.2...60 s
Repeat Accuracy		—	±15% of setting
Reset Time		—	75 ms
Timing Mode		—	On-Delay — convertible to OFF Delay, up to 2 poles convertible to N.O. or N.C.
Construction			
Contact Arrangement		Up to 8 Poles, Convertible to N.O. or N.C.	—
Contact Material		Silver	Silver
Mounting		Panel or strip mount Horizontal mounting recommended	On relay only
Environmental			
Ambient Temperature (Outside Enclosure)	Operating	-20...+40 °C (-4...+104 °F)	
	Storage	-40...+60 °C (-40...+140 °F)	
Operating Temperature Rise (Inside Enclosure)		+25 °C Max	—
Wire Terminations			
Wire size per UL/CSA		#18 AWG...(2) #12 AWG	
Tightening Torque		8...12 lb•in. (0.9...1.4 N•m)	

Application Data – Because of the inherent characteristics of this device, the normally open contacts may close before the normally closed contacts open on energization and the normally closed contacts may close before the normally open contacts open on de-energization.

Note: For Bul. 700-RM, energizing both the latch and unlatch coil together will cause the relay to be energized and both latch and unlatch coils can be operated together continuously.

Ratings

NEMA Rating Designation	AC Voltage				Continuous Carrying Current [A]	DC Voltage		
	Voltage	Make	Break	NEMA Rating Designation		Volts DC	Make/Break	Continuous Carrying Current [A]
B300	Up to 300V AC	120V	30	3	5	46...300	138 VA	5
		240V	15	1.5				
C600	Above 300V AC	480V	7.5	0.75	2.5	5...46	3 A	5
		600V	6.0	0.60				

Maximum Allowable Off-State Leakage Current

Voltage	Maximum Off-State Leakage Current [mA]	Maximum Off-State Leakage Current [mA]
	Type R	Type RM
24V DC	23	8
24V AC	23	8
120V AC	5	2

Relay Data

Type	700-R	700-RM
Contact Arrangement	Up to 8 poles, available in any combination of N.O. or N.C. contacts	Up to 8 poles, available in any combination of N.O. or N.C. contacts
Contact Material	W (tungsten in a controlled gas atmosphere)	W (tungsten in a controlled gas atmosphere)
Coil Voltage Range	24...250V AC 24...250V DC	24...250V AC 24...250V DC
Coil Power	Sealed Voltage Range: -15... +10%	5.5 VA, 50/60 Hz 5.5 W DC
	Inrush	1.7 VA, 50/60 Hz (latch or unlatch) 1.7 W DC
Pickup Time	5.5 VA, 50/60 Hz 5.5 W DC	1.7 VA, 50/60 Hz (latch or unlatch) 1.7 W DC
Dropout Time	30 ms	75 ms min. latch pulse
Operating Temperature	30 ms	75 ms min. unlatch pulse
Mounting	-40...+60 °C (-40...+140 °F)	-40...+60 °C (-40...+140 °F)
	Panel mount	Panel mount

Bulletin 700-R Operating Coils



Bulletin 700-R Operating Coil

Coil Volts	Bulletin 700-R 2-...8-Pole AC		Bulletin 700-R 2-...8-Pole DC
	60 Hz	50 Hz	
24	77AB27	77AB27	77D152
48	77AB134	77AB134	77D166
110	77AB86	77AB86	—
115...125	—	—	77D155
120	77AB86	77AB86	—
208	—	—	—
220	77AB83	77AB83	—
240	77AB83	77AB83	—
230...250	—	—	77D156

Bulletin 700-R, -RM
Sealed Switch Relays
 Approximate Dimensions

Dimensions are shown in millimeters (inches) shown. Dimensions are not intended to be used for manufacturing purposes.

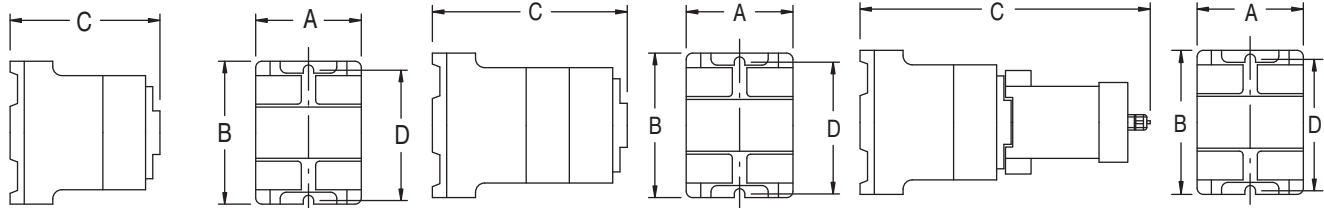

Bulletin 700-R400..., -RM400...

Bulletin 700-R800, -RM800...

Bulletin 700-R with 852s timer

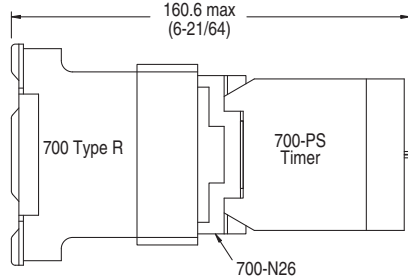

Bulletin 700-PS Timer Mounted on a 4-Pole Bulletin 700-R Relay

Approximate Shipping Weight: 1.25 kg (2.75 lb)

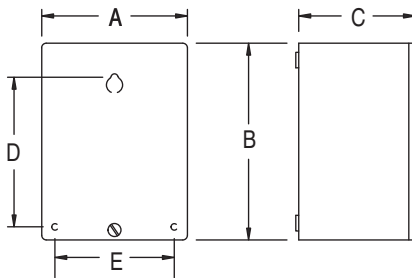

Type 1 Enclosure

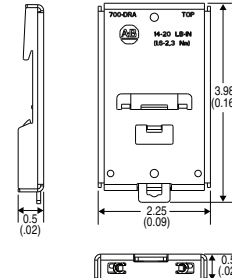

Secure the mounting strip with 2 screws at each end relay position. Use a minimum of one screw at the 3rd, 5th, 7th, etc., relay positions. Alternate between upper and lower horizontal slots.

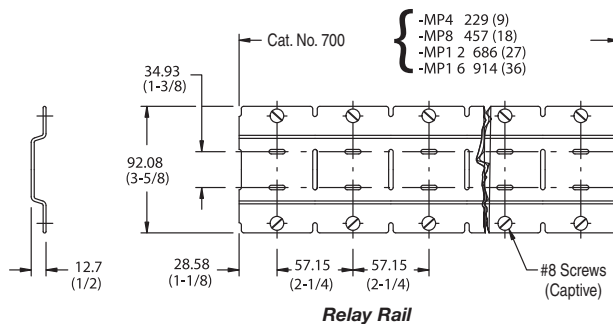

Relay Rail

- MP4 229 (9)
- MP8 457 (18)
- MP1 2 686 (27)
- MP1 6 914 (36)

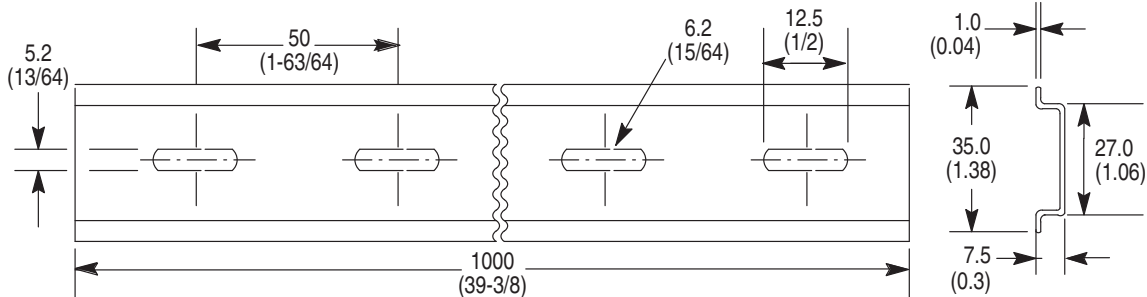

Cat. No. 199-DR1 DIN Mounting Rail Series B

Bulletin 700-R, -RM Relays

Type of Relay	No. of Poles	Drawing Number	Open Type Without Enclosures				Approx. Ship Wt. [kg (lb)]	Type 1 General Purpose Enclosure					Approx. Ship Wt. [kg (lb)]	
			A Wide	B High	C Deep	D		A Wide	B High	C Deep	D	E		
R	Bulletin 700 and Bulletin 700DC	2...4	1	55.56 (2-3/16)	88.90 (3-1/2)	92.25 (3-3/8)	79.38 (3-1/8)	0.91 (2)	104.78 (4-1/8)	185.74 (7-5/16)	103.19 (4-1/16)	146.05 (5-3/4)	85.73 (3-3/8)	1.81 (4)
		5...8	2	55.56 (2-3/16)	88.90 (3-1/2)	111.13 (4-3/8)	79.38 (3-1/8)	1.02 (2-1/4)	112.71 (4-7/16)	228.60 (9)	120.65 (4-3/4)	206.38 (8-1/8)	92.08 (3-5/8)	2.49 (5)
R with Bulletin 852S Timer	Bulletin 700 and Bulletin 700DC	2...4	3	55.56 (2-3/16)	88.90 (3-1/2)	165.1 (6-1/2)	79.38 (3-1/8)	1.25 (2-3/4)	—	—	—	—	—	—
RM	Bulletin 700 and Bulletin 700DC	2...4	1	55.56 (2-3/16)	88.90 (3-1/2)	95.25 (3-3/8)	79.38 (3-1/8)	0.91 (2)	104.78 (4-1/8)	185.74 (7-5/16)	103.19 (4-1/16)	146.05 (5-3/4)	85.73 (3-3/8)	1.81 (4)
		5...8	2	55.56 (2-3/16)	89.90 (3-1/2)	111.13 (4-3/8)	79.38 (3-1/8)	1.02 (2-1/4)	112.71 (4-7/16)	228.60 (9)	120.65 (4-3/4)	206.38 (8-1/8)	92.08 (3-5/8)	2.49 (5)
RM with Bulletin 852S Timer	Bulletin 700 and Bulletin 700DC	2...4	3	55.56 (2-3/16)	88.90 (3-1/2)	165.1 (6-1/2)	79.38 (3-1/8)	1.25 (2-3/4)	—	—	—	—	—	—

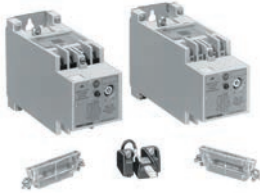

Bulletin 700-RTC — Solid-State Timing Relay

- Timing functions
- 8 ON-delay
- 8 OFF-delay
- Timing ranges
- Seconds: 0.05...2, 0.2...8, 0.4...30, 2...120
- Minutes: 0.015...1, 0.06...4, 0.25...16 and 1...64
- AC, 50/60 Hz or DC
- 600V AC maximum
- 300V DC maximum
- Relays with fixed time delay
- Sealed contacts
- Harsh environments
- Hazardous locations Class I, Div. 2, Groups A, B, C and D

Table of Contents

Product Selection this page
 Accessories..... 9-143
 Specifications..... 9-144
 Approximate
 Dimensions..... 9-144
**Standards Compliance and
 Certifications**
 See Specifications table in this
 section, page 9-144.

Bulletin 700-RTC Relay – Relays with Provision for Instantaneous Contacts

Relays listed below have slots for two timed contacts and two instantaneous contacts. Unused slots are equipped with removable dummy cartridges.



Total	Number of Contact Cartridges				Open Type Without Enclosure
	Instantaneous		Timed		
	N.O.	N.C.	N.O.	N.C.	Cat. No.*
0	0	0	0	0	700-RTC00000 ⊗
1	0	0	1	0	700-RTC00100⊗
	0	0	0	1	700-RTC00010⊗
2	0	0	2	0	700-RTC00200⊗
	1	0	1	0	700-RTC10100⊗
	0	1	1	0	700-RTC01100⊗
	0	0	1	1	700-RTC00110⊗
	1	0	0	1	700-RTC10010⊗
	0	1	0	1	700-RTC01010⊗
	0	0	0	2	700-RTC00020⊗
	1	0	2	0	700-RTC10200⊗
3	2	0	1	0	700-RTC20100⊗
	0	1	2	0	700-RTC01200⊗
	1	1	1	0	700-RTC11100⊗
	1	0	1	1	700-RTC10110⊗
	2	0	0	1	700-RTC20010⊗
	0	2	1	0	700-RTC02100⊗
	0	1	1	1	700-RTC01110⊗
	1	1	0	1	700-RTC11010⊗
	1	0	0	2	700-RTC10020⊗
	0	2	0	1	700-RTC02010⊗
4	0	1	0	2	700-RTC01020⊗
	2	0	2	0	700-RTC20200⊗
	1	1	2	0	700-RTC11200⊗
	2	0	1	1	700-RTC20110⊗
	0	2	2	0	700-RTC02200⊗
	1	1	1	1	700-RTC11110 ⊗
	2	0	0	2	700-RTC20020⊗
	1	1	0	2	700-RTC11020⊗
	0	2	1	1	700-RTC02110⊗
	0	2	0	2	700-RTC02020⊗

* To order a 700-RTC relay with the Remote Potentiometer Provision, add an "R" after the letters RTC in the catalog number. Only a "U24" (24V AC/DC) coil code is available with this option. For example: 700-RTC00000**U24**.

⊗ **Coil Voltage Code**

The Cat. No. as listed is not complete. Select a voltage code from the table below to complete the Cat. No. Example: **Cat. No. 700-RTC00100**⊗ becomes **Cat. No. 700-RTC00100U24**. For other voltages consult your local Rockwell Automation sales office or Allen-Bradley distributor.

[V]	24V DC, 24V AC	120V DC, 110/120V AC
50/60 Hz	U24	U1

Bulletin 700-RTC
Sealed Switch Timing Relays
 Product Selection

Bulletin 700-RTC Relays with Fixed Time Delay— Relays with Provision for Instantaneous Contacts

Relays listed below have slots for two timed and two instantaneous contacts. Unused slots are equipped with removable dummy cartridges.

	Number of Contact Cartridges					Open Type Without Enclosure
	Total	Timed		Instantaneous		
		N.O.	N.C.	N.O.	N.C.	Cat. No.*
	0	0	0	0	0	700-RTC00#0⊗
	1	1	0	0	0	700-RTC10#0⊗
		0	1	0	0	700-RTC20#0⊗
	2	2	0	0	0	700-RTC40#0⊗
		1	0	1	0	700-RTC11#0⊗
		1	0	0	1	700-RTC12#0⊗
		1	1	0	0	700-RTC30#0⊗
		0	1	1	0	700-RTC21#0⊗
		0	1	0	1	700-RTC22#0⊗
		0	2	0	0	700-RTC50#0⊗
		0	0	2	0	0
	3	2	0	1	0	700-RTC41#0⊗
		1	0	2	0	700-RTC14#0⊗
		2	0	0	1	700-RTC42#0⊗
		1	0	1	1	700-RTC13#0⊗
		1	1	1	0	700-RTC31#0⊗
		0	1	2	0	700-RTC24#0⊗
		1	0	0	2	700-RTC15#0⊗
		1	1	0	1	700-RTC32#0⊗
		0	1	1	1	700-RTC23#0⊗
		0	2	1	0	700-RTC51#0⊗
		0	1	0	2	700-RTC25#0⊗
		0	2	0	1	700-RTC52#0⊗
	4	2	0	2	0	700-RTC44#0⊗
		2	0	1	1	700-RTC43#0⊗
		1	1	2	0	700-RTC34#0⊗
		2	0	0	2	700-RTC45#0⊗
		1	1	1	1	700-RTC33#0⊗
		0	2	2	0	700-RTC54#0⊗
		1	1	0	2	700-RTC35#0⊗
		0	2	1	1	700-RTC53#0⊗
0	2	0	2	700-RTC55#0⊗		

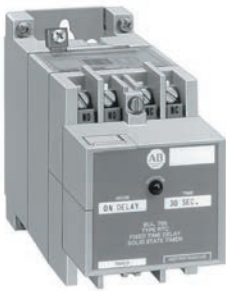

* Operating Mode
 Replace the # in the cat. no. with the appropriate letter and numbers to indicate the operating mode and the fixed time delay value. Refer to operating mode table below.

9

Digit	Operating Mode	Fixed Time Delay
S	On-Delay – s	Seconds –Two digits indicating the fixed time delay in seconds. Three digits indicating the fixed time delay (first digit indicates seconds, next two digits indicate 1/100 seconds).
Z	Off-Delay – s	
Y	On-Delay – Min.	Minutes –Two digits indicating the fixed time delay in minutes. Three digits indicating the fixed time delay (first digit indicates minutes, next two digits indicate 1/100 minutes).
I	Off-Delay – Min.	







Examples: **Cat. No. 700-RTC00Y200U1** is for a relay without contact cartridges. “Y20” indicates an On-Delay timer with a 20 minute fixed time delay. This is a “standard relay.” Order the contact cartridges separately. **Cat. No. 700-RTC42S020U1** is for a relay with 2 N.O. cartridges in the timed position and 1 N.C. cartridge in the instantaneous position. “S02” indicates an On-Delay timer with a 2 second fixed time delay.

⊗ **Coil Voltage Code**

The cat. no. as listed is not complete. To complete the cat. no., add a coil code selected from the table below.

[M]	24V DC, 24V AC	120V DC, 110/120V AC
50/60 Hz	U24	U1



 Cat. No. 700-CRT5 Cat. No. 700-CRT6 Cat. No. 700-CR9	Description Contact Cartridges – These cartridges are used to add contacts to timing relays having unused slots. The N.O., N.C., and Dummy cartridges are interchangeable and can be used in timed or instantaneous contact slots. Dummy cartridges should be placed in unused cartridge slots to guard against entrance of foreign material.	Cartridge Type N.O. N.C. Dummy Cartridge	Color Grey Orange Black	Cat. No. 700-CRT5 700-CRT6 700-CR9										
 Cat. No. 800MR-N37	External Potentiometer – The potentiometer units listed are recommended for timers with remote potentiometer provision. Refer to catalog section on Bulletin 800T or 800M for general construction features. Connection Cable – Use shielded twisted pair cable, maximum of 50 feet. Recommended cable (or equivalent): UL style 2517, having two #18 stranded conductors with aluminum mylar foil shield and #20 drain wire. Rated 150 °C, FR-1, 300 volts. ATTENTION – If the recommended potentiometer and cable are not used, be certain that the potentiometer and cable wiring is insulated from ground and circuit common for 300V RMS or greater.	Oiltight*⌘ Small Oiltight – Round*‡⌘ Small Oiltight – Square*§⌘		800T-U90 800MR-N37 800MS-N37										
	Type 1 Enclosure — Use for all Bulletin 700-P, -PH, and -PK relays except 10- and 12-pole DC relays or 5- and 6-pole DC Bulletin 700-PH relays.		700-N31											
	Relay Rail Simplifies panel layout. These indexed strips are easily cut to the required length and bolted, riveted, or spot-welded in place. Relays are installed adjacent to one another on the mounting strip with the captive mounting screws provided. Rows of relays on Relay Rail form their own wiring trough. Can be used with the following relays: 700P, 700-PK, 700PH, 700S-P, 700N, 700-R, 700-RTC	<table border="1"> <thead> <tr> <th>Relays per Strip</th> <th>Pkg. Quantity</th> </tr> </thead> <tbody> <tr> <td>4</td> <td>5</td> </tr> <tr> <td>8</td> <td>5</td> </tr> <tr> <td>12</td> <td>5</td> </tr> <tr> <td>16</td> <td>5</td> </tr> </tbody> </table>	Relays per Strip	Pkg. Quantity	4	5	8	5	12	5	16	5		700-MP4 700-MP8 700-MP12 700-MP16
Relays per Strip	Pkg. Quantity													
4	5													
8	5													
12	5													
16	5													
 Cat. No. 199-DR1	DIN (#3) symmetrical hat rail 35 x 7.5 x 1 m		10	199-DR1										
	DIN Rail Adapter Can be used with the following relays: Bulletin 700P, 700-PK, 700-PH, 700S-P, 700-N, 700-R, 700-RTC		1	700-DRA										

- * Legend plate, Cat. No. 800T-X609, must be specified when ordering.
- ⌘ Add suitable 400 KΩ potentiometer.
- ‡ Does not include legend plate.
- § Does not include legend plate. Contact your local Rockwell Automation sales office or Allen-Bradley distributor.
- ⌘ To order a 700-RTC relay with the Remote Potentiometer Provision, add a "R" after the letters RTC in the selected catalog number. Only a "U24" (24V AC/DC) coil code is available with this option. For example: 700-RTC**R00000U24**.

Sealed Switch Timing Relays

Specifications/Approximate Dimensions

Voltage and Power Requirements

AC Voltage +10% -15% 50/60 Hz	Total Power Required	Initiate Terminal Power	Maximum Allowable Leakage Current	Coil Code
24V AC	8 VA	4 VA	10 mA	U24
110/120V AC	9 VA	4 VA	2.4 mA	U1

DC Voltage +10% -20%	Total Power Required	Initiate Terminal Power	Maximum Allowable Leakage Current	Coil Code
24V DC	10 W	5 W	10 mA	U24
120V DC	11 W	5 W	2.4 mA	U1

Type	700-RTC	
Contact Rating (See pub. 700-SG003*)	NEMA B600 600V AC, 5 A NEMA P300 300V DC, 5 A	
Contact Arrangement	1...4 poles. Max. of 2 timed and 2 instantaneous. Available in any combination of N.O. and N.C. contacts	
Contact Material	W (tungsten in a controlled gas atmosphere)	
Operating Mode	Convertible to ON-Delay or OFF-Delay	
Timing Range	0.05...64 min.	
Reset Time	25 ms	
Repeat Accuracy	±1% (or ±50 ms) at constant voltage and temperature	
Mounting	Panel or strip mount	
Surge Suppression	Not required. Timers have internal suppression	
Certifications	UL Listed, File E10314, Guide NOIV, CSA Certified, File LR11924 Suitable for use in Class I, Division 2, Groups A, B, C, and D	
Maximum Allowable Leakage Current	24V AC/DC	10 mA
	110/120V AC, 120V DC	2.4 mA
Ambient Temperature*		
Operating:	-20...+60 °C (-4...+140 °F)	
Storage:	-20...+60 °C (-4...+140 °F)	

* Continuous duty units placed close to each other (3 in a row) have a temperature range of -20...+45 °C (-4...+113 °F) or should have air circulated around the units. Approximate space of 3/4 in (mm) on all sides is needed.

Typical Wiring Diagram

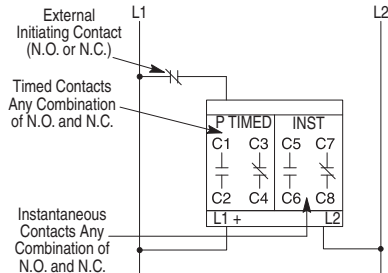

Approximate Dimensions

Approximate Dimensions are shown in millimeters (inches). Approximate Dimensions are not intended to be used for manufacturing purposes.

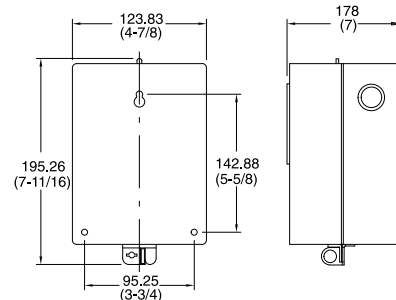
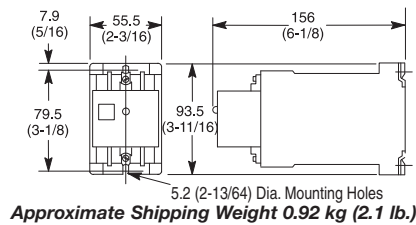

	<p>Bulletin 700-PS — Solid State Timing Relay</p> <ul style="list-style-type: none"> • Solid-state timer • 600V AC maximum, 300V DC maximum • Time range 0.1...120 sec • Can be attached to a Bulletin 700 Type P, PK, R and RM relay • Convertible to ON-Delay or OFF-Delay 	<p>Table of Contents</p> <p>Product Selection this page</p> <p>Specifications..... this page</p> <p>Approximate Dimensions..... 9-146</p> <p>Standards Compliance</p> <p>UL 508 CSA C22.2 No. 14</p> <p>UL 1604 C22.2 No. 213</p> <p>Certifications</p> <p>cULus Listed (File No. E10319, Guide NOIV/NOIV7)</p> <p>CSA Certified (File No. LR11924)</p>
--	--	--

Bulletin 700-PS

<p>Cat. No. 700-PSA1</p>	Operating Mode	Timing Range*[s]	Timing Relay with Self-Contained Potentiometer Unit Cat. No.	Timing Relay for Use with External Potentiometer Unit Cat. No.
	On-Delay	0.1...2	700-PSAA1	700-PSRAA1
		0.4...8	700-PSBA1	700-PSRBA1
		1.5...30	700-PSCA1	700-PSRCA1
		6...120	700-PSDA1	700-PSRDA1
	Off-Delay	0.1...2	700-PSPA1	700-PSRPA1
		0.4...8	700-PSRA1	700-PSRRA1
		1.5...30	700-PSTA1	700-PSRTA1
		6...120	700-PSUA1	700-PSRUA1

Accessories

<p>Cat. No. 700-N25</p>	Description		Cat. No.	
	Adapter Plate — For mounting Bulletin 700-PS timers directly on a panel or on Bulletin 700-MP universal mounting strips.		700-N25	
	Adapter for Bulletin 700-R, -RM Relays Allows you to mount the Bulletin 700-PS timer on a 1...4 pole Bulletin 700-R or -RM relay.		700-N26	
	Timing Range*	Resistance[mΩ]		
	0.1...2 (0.4...8)	0.75	⊛	700-N35
0.1...2 (0.4...8)	0.75	⊛	700-N35	
1.5...30	2.0	⊛	700-N36	
6...120	3.5	⊛	700-N37	

* The maximum range may be 50% greater and the minimum range may be 50% less than the values specified.

⊛ This Cat. No. includes only the potentiometer. Order **Cat. No. 800T-N37** for the potentiometer operator and housing.

Specifications

Bulletin 700-PS

Operation

The timer must be energized continuously (L1-L2). ON-Delay: When the initiating contact closes, timing begins. At time-out, the output contact closes. OFF-Delay: When the initiating contact closes, the output contact closes instantly. When the initiating contact re-opens, timing begins. At time-out, the output contact re-opens.

Typical Wiring Diagram†

Attention — To avoid damage to timer, do not switch any load in addition to timing relay at terminals S1–S2. Do not apply an external voltage to terminals S1–S2.

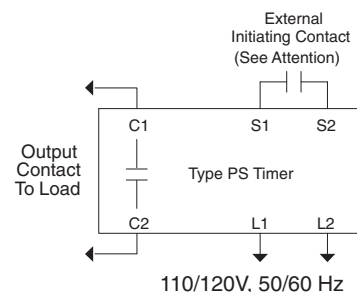

† External Potentiometer units have R1, R2 terminals for connecting the potentiometer.

Bulletin 700-PS
Industrial Timing Relays
 Approximate Dimensions

Approximate Dimensions

Dimensions are shown in millimeters (inches). Dimensions are not intended to be used for manufacturing purposes.

Bulletin 700-PS

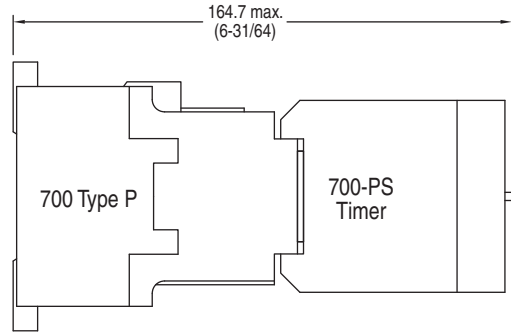
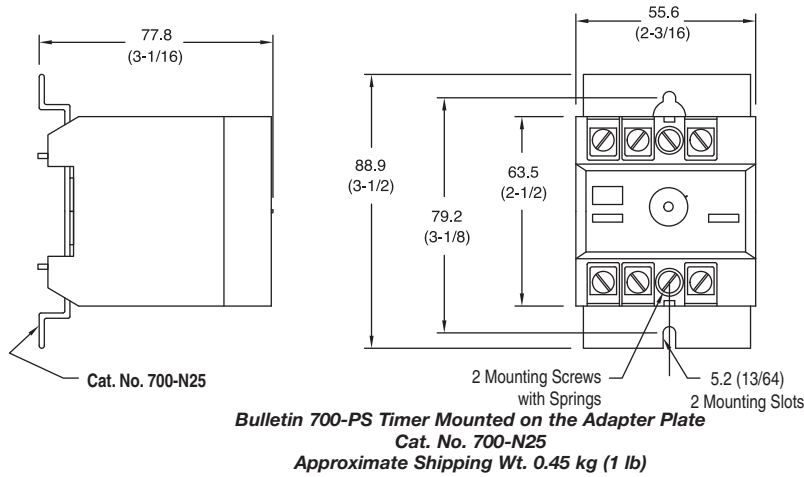

Bulletin 700-PS Timer Mounted on a 4-Pole Bulletin 700-P or -PK, or 2-Pole Bulletin 700-PH Relay
 Approximate Shipping Wt. 1.02 kg (2.3 lb)

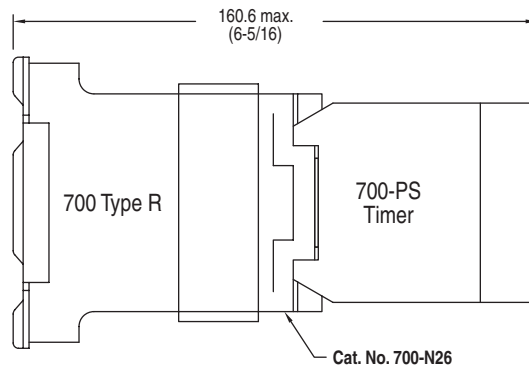

Bulletin 700-PS Timer Mounted on a 4-Pole Bulletin 700-R or -RM Relay
 Approximate Shipping Wt. 1.25 kg (2.8 lb)

9



Bulletin 700-CF — Control Relay

- IEC industrial relays
- Mechanically linked contact performance per IEC 60947-5-1
- Gold plated, bifurcated version for low level switching applications
- Master control relay version rated 15 A (AC-15)
- Solid-state and pneumatic timing modules
- 4-...10 Poles

Certifications

cULus Listed (File No. E14840, Guide NKCR/NKCR7)
CE Marked
CCC Certified

Table of Contents

Product Selection this page
Accessories..... 9-150
Specifications..... 9-154
Approximate Dimensions..... 9-156
Standards Compliance
UL 508
CSA C22.2 No. 14
EN/IEC 60947-1, -5-1
Meets the material restrictions for European Directive 2002/95/EC - EU-RoHS

4-Pole AC Coil Voltage (Ratings for 700-CF Only)

AC-12		AC-15							Connection Diagrams	Contacts		Standard Contacts Cat. No.*	Gold Plated Bifurcated Contacts Cat. No.*	Master Contacts Cat. No.*
I_{th} [A]		I_e [A]								N.O.	N.C.			
40 °C	60 °C	24/48V	120V	240V	400V	500V	600V	690V						
20	20	10	10	10	6	2.5	1	1		2	2	700-CF220*	700-CFB220*	700-CFM220*
										3	1	700-CF310*	700-CFB310*	700-CFM310*
										4	0	700-CF400*	700-CFB400*	700-CFM400*
										0	4	700-CF040*	700-CFB040*	—

* For spring clamp terminals, insert **R** after 700-C. Example: **Cat. No. 700-CRF220D**.

⊗ AC Coil Voltage Code

The cat. no. as listed is incomplete. Select a coil voltage code from the table below to complete the cat. no. Example: **Cat. No. 700-CF220*** becomes **Cat. No. 700-CF220D** for 120V, 60 Hz

[V]	12	24	32	36	42	48	100	110	120	127	200	220	208	220	230	240	277	347	380	380	400	400	415	440	480	500	550	600
50 Hz	R	K	V	W	X	Y	KP	—	D	P	S	KG	L	—	F	—	VA	T	—	—	N	—	G	B	—	M	C	—
60 Hz	Q	J	—	V	—	X	—	KP	—	D	—	—	KG	H	L	—	—	A	T	I	E	—	—	N	B	—	—	C
50/60 Hz	—	KJ	—	—	—	KY	KP	—	KD	—	—	KG	KL	—	KL	KF	—	KA	—	—	—	KN	—	KB	—	—	—	—

4-Pole DC Coil Voltage (Ratings for 700-CF Only)

AC-12		AC-15							Connection Diagrams	Contacts		Standard Contacts Cat. No.‡	Gold Plated Bifurcated Contacts Cat. No.*	Master Contacts Cat. No.*
I_{th} [A]		I_e [A]								N.O.	N.C.			
40 °C	60 °C	24/48V	120V	240V	400V	500V	600V	690V						
20	20	10	10	10	6	2.5	1	1		2	2	700-CF220*	700-CFB220*	700-CFM220*
										3	1	700-CF310*	700-CFB310*	700-CFM310*
										4	0	700-CF400*	700-CFB400*	700-CFM400*

‡ For spring clamp terminals, insert **R** after 700-C. Example: **Cat. No. 700-CRF220ZJ**.

* Ratings for Bulletin 700-CFB and 700-CFM are on page 9-159

⊗ DC Coil Voltage Code§

The cat. no. as listed is incomplete. Select a coil voltage code from the table below to complete the cat. no. example: **Cat. No. 700-CF220*** becomes **Cat. No. 700-CF220ZJ** for 24V DC

[V]	9	12	24	36	48	48... 72	60	64	72	80	110	110... 125	115	125	220	220... 250	230	250
Standard	ZR	ZQ	ZJ	ZW	ZY	—	ZZ	ZB	ZG	ZE	ZD	—	ZP	ZS	ZA	—	ZF	ZT
Standard diode	—	—	DJ	—	—	—	—	—	—	—	—	—	—	—	—	—	—	—
Electronic with diode	—	EQ	EJ	—	—	EY	—	—	—	—	—	ED	—	—	—	EA	—	—

§ When ordering DJ coil with built-in surge suppression, the DJ is not polarity sensitive. Drop out time: 14...20 ms.

6- and 8-Pole Relays



Cat. No. 700-CFZ1420

Cat. No. 700-CFZ0530

Control Relays with Overlapping Side-Mounted Contacts

AC-12			AC-15							Left Aux.	Relay Arrangement	Right Aux.	Contacts		Overlapping Side-Mounted Contacts		Cat. No.
I_{th} [A]		24/48V	120V	240V	400V	500V	600V	690V	N.O.				N.C.	N.O.	N.C.		
40 °C	60 °C																
Main Relay	20	20	10	10	10	6	2.5	1	1			4	0	1	1	700-CFZ1510⊗	
												3	1	1	1	700-CFZ1420⊗	
												2	2	1	1	700-CFZ1330⊗	
Side Contacts	10	10	6	6	5	3	1.6	1	1			4	0	2	2	700-CFZ2620⊗	
												3	1	2	2	700-CFZ2530⊗	
												2	2	2	2	700-CFZ2440⊗	

Control Relays with Standard Side-Mounted Contacts

AC-12			AC-15							Left Aux.	Relay Arrangement	Right Aux.	Contacts		Standard Side-Mounted Contacts		Cat. No.
I_{th} [A]		24/48V	120V	240V	400V	500V	600V	690V	N.O.				N.C.	N.O.	N.C.		
40 °C	60 °C																
Main Relay	20	20	10	10	10	6	2.5	1	1			4	0	1	1	700-CFZ0510⊗	
												3	1	1	1	700-CFZ0420⊗	
												2	2	1	1	700-CFZ0330⊗	
Side Contacts	10	10	6	6	5	3	1.6	1	1			4	0	2	2	700-CFZ0620⊗	
												3	1	2	2	700-CFZ0530⊗	
												2	2	2	2	700-CFZ0440⊗	

⊗ AC Coil Voltage Code

The cat. no. as listed is incomplete. Select a coil voltage code from the table below to complete the cat. no. Example: **Cat. No. 700-CFZ0510⊗** becomes **Cat. No. 700-CFZ0510F**.

[V]	12	24	32	36	42	48	100	100 ... 110	110	120	127	200	200 ... 220	208	240	220 ... 230	230	240	240	277	347	380	380 ... 400	400	400 ... 415	440	480	500	550	600
50 Hz	R	K	V	W	X	Y	KP	—	D	P	S	KG	L	—	—	F	—	VA	T	—	—	—	N	—	G	B	—	M	C	—
60 Hz	Q	J	—	V	—	X	—	KP	—	D	—	KG	H	L	—	—	—	A	T	I	E	—	—	—	—	N	B	—	—	C
50/60 Hz	—	KJ	—	—	—	KY	KP	—	KD	—	—	KG	KL	—	—	KL	KF	—	KA	—	—	—	—	KN	—	KB	—	—	—	





Assignment of Contacts
 Device Combinations in Accordance with IEC 60947-1 / -4-1

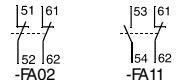
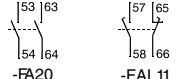

Auxiliary Contact Blocks		Control Relays 700-CF (AC and DC Control)			
Circuit Diagram	Control	700-CF⊗220	700-CF⊗310	700-CF⊗400	
Front Mounting *					
100-FA02		AC/DC	22E + 02E = 24Y	31E + 02E = 33Y	40E + 02E = 42Y
100-FA11		AC/DC	22E + 11E = 33Y	31E + 11E = 42Y	40E + 11E = 51Y
100-FA20		AC/DC	22E + 20E = 42Y	31E + 20E = 51Y	40E + 20E = 60Y
100-FA22		AC/DC	22E + 22E = 44Y	31E + 22E = 53Y	40E + 22E = 62Y
100-FA31		AC/DC	22E + 31E = 53Y	31E + 31E = 62Y	40E + 31E = 71Y
100-FA40		AC/DC	22E + 40E = 62Y	31E + 40E = 71Y	40E + 40E = 80Y
100-FAL22		AC/DC	22E + L22E = L44Y	31E + L22E = L53Y	40E + L22E = L62Y

* Control relay and auxiliary contact block AC/DC max. 4 N. C.

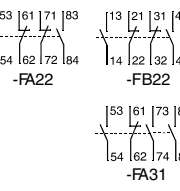
Auxiliary Contacts

	Description	N.O.	N.C.	Connection Diagrams	For Use With	Standard Contacts*	Bifurcated Contacts
						Cat. No.	Cat. No.
	Auxiliary Contact Blocks for Front Mounting‡ 2- and 4-pole Quick and easy mounting without tools Electronic-compatible contacts down to 17V, 5 mA Mechanically linked performance between N.O. and N.C. poles and to the main relay poles (except for L types) Models with equal function with several terminal numbering choices 1L = Late break N.C./early make N.O. Bifurcated version for switching down to 5V, 3 mA	0	2		700-CF	100-FA02	100-FAB02
		1	1			100-FA11	100-FAB11
		2	0	100-FA20		100-FAB20	
		1L	1L	100-FAL11		—	
		0	4			100-FA04	100-FAB04
		1	3			100-FA13	100-FAB13
		2	2	100-FA22		100-FAB22	
		3	1	100-FA31		100-FAB31	
		4	0	100-FA40		100-FAB40	
				1+1		1+1	
L	L						

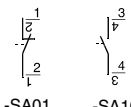
* For spring clamp terminals, insert **CR** after 100-. Example: **Cat. No. 100-CRFA02**.

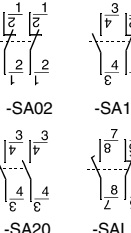
	Description	N.O.	N.C.	Connection Diagrams	For Use With	Cat. No.
	Auxiliary Contact Blocks for Side Mounting without Sequence Terminal Designations‡ 1- and 2-pole Two-way numbering for right or left mounting on the contactor Quick and easy mounting without tools Electronic-compatible contacts down to 17V, 10 mA Mirror contact performance to the main relay poles 1L = Late break N.C./early make N.O.	0	1		700-CF	100-SA01
		1	0			100-SA10
		0	2			100-SA02
		1	1			100-SA11
		2	0			100-SA20
		1L	1L		700-CF	100-SAL11

‡ For maximum no. of contacts: Refer to the following tables.

700-CF (AC and DC electronic coils), vertical mounting, 60 °C >

Cat. No. 700...	Max. N.O. Side Aux.	Max. N.C. Side Aux.	Max. N.O. Front Aux.	Max. N.C. Front Aux.	Max. N.O. Front + Side Aux.	Max. N.C. Front + Side Aux.	Max. N.O. + N.C. Front + Side Aux.
CF400	2	4	4	4	6	7	8
CF310	2	4§	4	4♣	6	5	8
CF220	4	4§	4	2	8	5	8
CF040	2	2	4	0	6	2	6

700-CF (DC conventional coils), vertical mounting, 60 °C >

Cat. No. 700...	Max. N.O. Side Aux.	Max. N.C. Side Aux.	Max. N.O. Front Aux.	Max. N.C. Front Aux.	Max. N.O. Front + Side Aux.	Max. N.C. Front + Side Aux.	Max. N.O. + N.C. Front + Side Aux.
CF400	2	2	4	4♣	6	5	8
CF310	2	2	4	4♣	6	5	8
CF220	2	2	4	2	6	4	8

♣ With no side auxiliary contacts installed. Otherwise 3 N.C. Maximum







> For other operating conditions, please contact your local Rockwell Automation sales office or Allen-Bradley distributor.

§ With no front auxiliary contacts installed. Otherwise 3 N.C. Maximum

♣ With no side auxiliary contacts installed. Otherwise 3 N.C. Maximum

> For other operating conditions, please contact your local Rockwell Automation sales office or Allen-Bradley distributor.

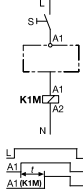
Control Modules

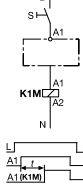
	Description	Connection Diagrams	Reset Time	Repeat Accuracy	Delay	For Use With	Cat. No.
	Pneumatic Timing Modules* ON-Delay Pneumatic timing element contacts switch after the delay time. The contacts on the main control relay continue to operate without delay.		25...90 ms for AC Coils	+/-10%	0.3...30 s	700-CF all*	100-FPTA30
					1.8...180 s		100-FPTA180
	Pneumatic Timing Modules OFF-Delay Pneumatic timing element contacts switch after the delay time. The contacts on the main control relay continue to operate without delay.		47...85 ms for DC coils		0.3...30 s		100-FPTB30
					1.8...180 s		100-FPTB180
	Electronic Timing Modules — On-Delay Delay of the control relay coil assembly. The control relay is energized at the end of the delay time.		100 ms	+/-1%	0.1...3 s	700-CF 110...240V AC 110...250V DC coils	100-ETA3
					1...30 s		100-ETA30
					10...180 s		100-ETA180
					0.1...3 s	700-CF 24...48V DC coils	100-ETAZJ3
					1...30 s		100-ETAZJ30
					10...180 s		100-ETAZJ180
 <p>Cat. No. 100-ETB30</p>	Electronic Timing Modules — Off-Delay Delay of the control relay coil assembly. After interruption of the control signal, the control relay is deenergized at the end of the delay time.		100 ms	+/-1%	0.3...3 s	700-CF 110...240V AC coils	100-ETB3
					1...30 s		100-ETB30
					10...180 s		100-ETB180
					0.3...3 s	700-CF 24V AC coils	100-ETBKJ3
					1...30 s		100-ETBKJ30
					10...180 s		100-ETBKJ180

* On-Delay modules cannot be used with side-mounted auxiliary contacts on DC coil relays.

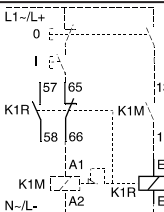
	Description	Connection Diagrams	For Use With	Cat. No.
 <p>Cat. No. 100-FL⊗</p>	Mechanical Latch Following relay latching, the relay coil is immediately de-energized (off) by the N.C. auxiliary contact (65-66). Electrical or manual release 1 N.O. + 1 N.C. auxiliary contacts		700-CF with AC coils	100-FL11⊗

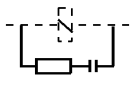
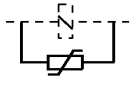
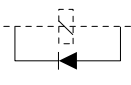
	Description	Connection Diagrams	For Use With	Cat. No.*	
	RC Module AC Operating Mechanism		700-CF with AC coils	24...48V 50/60 Hz	
				110...280V 50/60 Hz	
				380...480V 50/60 Hz	
	Varistor Module AC/DC Operating Mechanism		700-CF all	12...55V AC/ 12...77V DC	
				56...136V AC/ 78...180V DC	
				137...277V AC/ 181...350V DC	
				278...575V AC	
	Diode Module DC Operating Mechanism Dropout Time 70...95 ms		700-CF with DC coils	12...250V DC	100-FSD250

* For spring clamp terminals, insert **CR** after 100-. Example: **Cat. No. 100-CRFSC48**.

⊗ **Coil Voltage Code**

The cat. no. as listed is incomplete. Select a coil voltage code from the table below to complete the cat. no. Example: **Cat. No. 100-FL11⊗** becomes **Cat. No. 100-FL11J.‡**

[V]	24	48	100	110	120	230...240	240	277	380...400	400...415	440	480
50 Hz	K	Y	KP	D	—	VA	T	—	N	G	B	—
60 Hz	J	—	—	—	D	—	A	T	—	—	N	B

‡ For special voltages, consult your local Rockwell Automation sales office or Allen-Bradley distributor.



IEC Industrial Control Relays

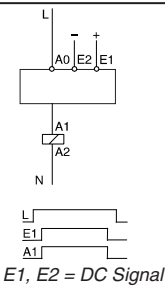

Accessories

	Description (Relays)	Connection Diagrams	For Use With (Relays)	Cat. No.	
 Cat. No. 100-JE	DC Interface (electronic) Interface between the DC control signal (PLC) and the AC operating mechanism of the control relay. Control (input) voltage 12V DC 18...30V DC (24V nominal) 48V DC Requires no additional surge suppression on the relay coils	Input: 18...30V DC Output: 110...240V AC Input: 12V DC Output: 110...240V AC Input: 48V DC Output: 110...240V AC	 E1, E2 = DC Signal	700-CF with 110...240V AC coils	100-JE
					100-JE12
					100-JE48

	Cat. No. 100-JE	Cat. No. 100-JE12	Cat. No. 100-JE48		
Electrical					
Input Voltage	24V DC	12V DC	48V DC		
Input Voltage Range	18...30V DC	6...12V DC	35...48V DC		
Output Voltage	110...240V AC	110...240V AC	110...240V AC		
Power Consumption	0.1...0.4 W	0.02...0.12 W	0.2...0.5 W		
Minimum Actuation	5V DC, 2 mA DC	5V DC, 2 mA DC	5V DC, 2 mA DC		
Mechanical					
Finger Protection	IP20	IP20	IP20		
Pickup Time	0...10 ms + pickup time of the contactor	0...10 ms + pickup time of the contactor	0...10 ms + pickup time of the contactor		
Dropout Time	0...10 ms + dropout time of the contactor	0...10 ms + dropout time of the contactor	0...10 ms + dropout time of the contactor		
Max. Cycles Per Second	2*	2*	2*		
Isolation/Breakdown Voltage	In: 50V, Out: 250V	In: 50V, Out: 250V	In: 50V, Out: 250V		
Rated Impulse Withstand Voltage	4 kV	4 kV	4 kV		
Environmental					
Ambient Temperature Range	-25...60 °C	-25...60 °C	-25...60 °C		
Storage Temperature Range	-50...+80 °C	-50...80 °C	-50...80 °C		
Operating Life	100+ million ops	100+ million ops	100+ million ops		
Construction					
Wire Size Range	Flexible wire	1 Wire	0.5...2.5 mm ²	0.5...2.5 mm ²	0.5...2.5 mm ²
		2 Wire	0.75...2.5 mm ²	0.75...2.5 mm ²	0.75...2.5 mm ²
	Solid wire	1 Wire	1.0...2.5 mm ²	1.0...2.5 mm ²	1.0...2.5 mm ²
		2 Wire	1.0...2.5 mm ²	1.0...2.5 mm ²	1.0...2.5 mm ²
Solid and Stranded			18...14 AWG	18...14 AWG	18...14 AWG
Tightening Torque			1...1.5 N•m/7...15 lb•in	1...1.5 N•m/7...15 lb•in	1...1.5 N•m/7...15 lb•in
Type of Light			LED	LED	LED

* To consider the maximum operations/hour of the relays.





Assembly Components

	Description	For Use With	Pkg. Quantity*	Cat. No.
 Cat. No. 100-SCCA	Protective Covers Provides protection against unintended manual operation	700-CF all	1	100-SCCA
 Cat. No. 100-SCFA	Protective Covers Provides protection against unintended manual operation For front mounted auxiliary contacts, pneumatic timers and latches	100-FA, -FB, -FC, -FP, -FL;	10	100-SCFA



Marking Systems

Uniform labelling materials for contactors, motor startup equipment, relays, and circuit breakers.

	Description	Pkg. Quantity*	Cat. No.
	Label Sheet 105 self-adhesive paper labels each, 6 x 17 mm	10	100-FMS
	Marking Tag Sheet 160 perforated paper labels each, 6 x 17 mm, to be used with a transparent cover	10	100-FMP
	Transparent Cover To be used with marking tag sheets	100	100-FMC
	Marking Tag Adapters To be used with marking tag: System V4/V5	100	100-FMA1
	System 1492 W		100-FMA2

* Must be ordered in multiples of package quantities.

Coils

	AC Coil Code	AC Voltages			Cat. No. 700-CF	DC Coil Code	DC Voltages	Cat. No. 700-CF
		50Hz	60Hz	50/60Hz				
	Q	—	12V	—	TA006	ZR	9V	TA766
	R	12V	—	—	TA404	ZQ	12V	TA708
	J	—	24V	—	TA013	DJ	24V Diode	TA714M
	K	24V	—	—	TA407	ZJ	24V	TA714
	KJ	—	—	24V	TA855	ZW	36V	TA719
	V	32V	36V	—	TA481	ZY	48V	TA724
	W	36V	—	—	TA410	ZZ	60V	TA774
	X	42V	48V	—	TA482	ZB	64V	TA727
	Y	48V	—	—	TA414	ZG	72V	TA728
	KY	—	—	48V	TA860	ZE	80V	TA729
	KP	100V	100 - 110V	100V	TA861	ZD	110V	TA733
	D	110V	120V	—	TA473	ZP	115V	TA734
	KD	—	—	110V	TA856	ZS	125V	TA737
	P	120V	—	—	TA425	ZA	220V	TA747
	S	127V	—	—	TA428	ZF	230V	TA749
	KG	200V	200 - 220V	200V	TA862	ZT	250V	TA751
	H	—	208V	—	TA049	—	—	—
	L	200 - 220V	208 - 240V	—	TA296	—	—	—
	KL	—	—	200 - 230V	TA864	—	—	—
	A	220V	240V	—	TA474	—	—	—
	F	220 - 230V	260V	—	TA441	—	—	—
	KF	—	—	230V	TA851	—	—	—
	VA	230 - 240V	—	—	TA440	—	—	—
	T	240V	277V	—	TA480	—	—	—
	KA	—	—	240V	TA858	—	—	—
	I	—	347V	—	TA065	—	—	—
	E	—	380V	—	TA067	—	—	—
	N	380 - 400V	440V	—	TA071	—	—	—
	KN	—	—	400V	TA863	—	—	—
	G	400-415V	—	—	TA457	—	—	—
	B	440V	480V	—	TA475	—	—	—
	KB	—	—	440V	TA859	—	—	—
	M	500V	—	—	TA479	—	—	—
	C	550V	600V	—	TA476	—	—	—



Bulletin 700-CF, 700-CFB, 700-CFM
IEC Industrial Control Relays
 Specifications

General

		Main Relay Cat. Nos. 700-CF, 700S- CF	Front Mounted Standard Auxiliary Contacts	Main Relay Cat. No. 700-CFB, 700S- CFB	Master Relay Cat. No. 700-CFM	Front Mounted Bifurcated Auxiliary Contacts	Side-mounted Auxiliary Contacts
Contact Ratings — NEMA		A600, P600	A600, Q600	A600, Q600	2 x A600, P600	A600, Q600	A600, Q600
Min. Contact Rating		17V, 10 mA	17V, 5 mA	8V, 5 mA	—	5V, 3 mA	17V, 10 mA
Contact Ratings — IEC AC-15 (solenoids, contactors) at rated voltage IEC 60947-5-1	24V	10 A	6 A	3 A	15 A	3 A	6 A
	48V	10 A	6 A	3 A	15 A	3 A	6 A
	120V	10 A	6 A	3 A	15 A	3 A	6 A
	240V	10 A	5 A	3 A	15 A	3 A	5 A
	400V	6 A	3 A	2 A	7.5 A	2 A	3 A
	480V/500V	2.5 A	1.6 A	1.2 A	5 A	1.2 A	1.6 A
	600V	1 A	1 A	0.7 A	2 A	0.7 A	1 A
AC-12 (Control of resistive loads) IEC 60947-5-1	40 °C	I_{th}	20 A	10 A	10 A	20 A	10 A
		230V	8 kW				
		400V	14 kW				
		690V	24 kW				
	60 °C	I_{th}	20 A	6 A	6 A	20 A	6 A
		230V	8 kW				
		400V	14 kW				
		690V	24 kW				
DC-12 Switching DC Loads L/R < 1ms, Resistive Loads IEC 60947-5-1	24V	15 A	10 A	6 A	20 A	6 A	6 A
	48V	10 A	9 A	3.2 A	20 A	3.2 A	3.2 A
	110V	6 A	3.5 A	1 A	8 A	1 A	1 A
	220V	1 A	0.7 A	0.5 A	1.5 A	0.5 A	0.5 A
	440V	0.4 A	0.2 A	0.2 A	0.4 A	0.2 A	0.2 A
DC-13 IEC 60947-5-1, Solenoids and contactors	24V	5 A	5 A	2.5 A	5 A	2.5 A	5 A
	48V	3 A	3 A	1.5 A	3 A	1.5 A	2.5 A
	110V	1.2 A	1.2 A	0.6 A	1.2 A	0.6 A	0.68 A
	220V	0.6 A	0.6 A	0.3 A	0.6 A	0.3 A	0.32 A
	440V	0.3 A	0.15 A	0.15 A	0.3 A	0.15 A	0.15 A



Location of welded N.O. contacts	State of N.C. Contacts if N.O. contact welds		
	Main	Front aux.	Side aux.
Main	Open	Open	Open*
Mechanically Linked Contacts*	Front aux.	Open	Open

* Side mounted auxiliary contacts provide “mirror contact” performance with main poles only.

* Defined in IEC 60947-5-1 annex L. Mechanically linked is a relationship between contacts of opposite types (i.e., N.O. and N.C.).

9

		Cat. No. 700-CF	Aux./Pneu matic Timer Contact (Front- mounted)
Mechanical Life	[Mil]	15	5
Electrical Life	AC-15 (240V, 3 A) [Mil]	1.5	1.5
Weight	AC Coil [g]	390	—
Terminal Cross-Sections			
Terminal Type			
Terminal Size per IEC60 947-1		2 x A4	2 x A4
	Solid/ Stranded	1 Conductor	[mm²] 1.5...6 0.5...2.5
	§	2 Conductor	[mm²] 1.5...6 0.75...2.5
Max. Wire Size per UL/CSA		[AWG] 16...10	18...14
Tightening Torque		[lb-in] 13.3...22	8.9...13.3
Tightening Torque		[N-m] 1.5...2.5	1...1.5

DC Switching Ratings for 700-CF Main Poles in Series (Resistive Load at 60 °C)			
	1 pole	2 poles	3 poles
24/48V	25/20 A	25 A	25 A
125V	6 A	25 A	25 A
220V	1.5 A	8 A	25 A
440V	0.4 A	1 A	3 A

§ For 16 or more strands, end ferrule is required.

www.ab.com/catalogs Preferred availability cat. nos. are bold.



Control Circuit

			Cat. No. 700-CF
Operating Voltage			
AC 50/60 Hz	Pickup	[x U _s]	0.85...1.1
	Dropout	[x U _s]	0.3...0.6
DC*	Pickup	[x U _s]	0.8...1.1
	Dropout	[x U _s]	0.1...0.6
Coil Consumption			
AC 50/60 Hz	Inrush	[VA/W]	70/50
	Seal	[VA/W]	8/2.6
DC (conventional)	Inrush/Seal	[W]	6.5
DC (electronic)	Inrush (avg./peak)	[W]	10/17
	Seal	[W]	1.7
Operating Times			
AC 50/60 Hz	Pickup Time	[ms]	15...30
	Dropout Time	[ms]	10...60
DC (conventional)	Pickup Time	[ms]	40...70
	Dropout Time	[ms]	7...15
DC (electronic)	Pickup Time	[ms]	25...50
	Dropout Time	[ms]	25...50
Min OFF time		[ms]	200
Max. ripple			± 15%
Latch Attachment Release, 100-FL			
Coil Consumption	AC	[VA/W]	45/40
	DC	[W]	25
Contact Signal Duration		[min./max]	0.03...15 s
Timing Attachment			
Reset Time, 100-ETA, 100-ETB	at min. time setting	[ms]	10
	at max. time setting	[ms]	70
Repeat Accuracy			± 10%

* For 9V DC, code ZR, use operating voltage 0.65...1.3 x U_s.
For 24V DC, code ZJ, DJ, or EJ use operating voltage 0.7...1.25 x U_s.
For 110V DC, code ED use operating voltage 0.7...1.25 x U_s.

General

		Cat. No. 700-CF
Rated Insulation Voltage U_i		
IEC		690V
UL; CSA		600V
Rated Impulse Strength U_{imp}		6 kV
High Test Voltage 1 minute (per IEC 60947-4)		2500V
Rated Voltage U_e		
AC		115, 230, 400, 500, 690V
DC		24, 48, 110, 220, 440V
Short-Circuit Protection gG Fuse 10 A		
Rated Frequency		50/60 Hz, DC
Ambient Temperature		
Storage		-55...+80 °C (-67...176 °F)
Operation at nominal current		-25...+60 °C (-13...140 °F)
15% current reduction for AC-12 at > 60 °C		-25...+70 °C (-13...158 °F)
Corrosion Resistance		humid-alternating climate, cyclic, per IEC 60068-2-30 and DIN 50 016, 56 cycles
Altitude		2000 m above mean sea level, per IEC60 947-4
Type of Protection		
IP2X (IEC 60529 and DIN 40050)		in connected state
Shock Resistance		IEC 60068-2: Half sinusoidal shock 11 ms, 30 G (in 3 directions)
Vibration Resistance		IEC 60068-2: Static >2 G, in normal position no malfunction <5 G

Utilization Category Table from EN 60947-5-1

Verification of Making and Breaking Capacities of Switching Elements Under Normal Conditions
Corresponding to the Utilization Categories*

Utilization Category	Normal Condition of Use								
	Make‡			Break‡			Number and Rate of Making and Breaking operations		
	I/I _e	U/U _e	cos ψ	I/I _e	U/U _e	cos ψ	No. operating cycles§	Operating cycles per minute	ON time [s]➤
AC-12⌘	1	1	0.9	1	1	0.9	6050	6	0.05
AC-13⌘	2	1	0.65	1	1	0.65	6050	6	0.05
AC-14⌘	6	1	0.3	1	1	0.3	6050	6	0.05
AC-15⌘	10	1	0.3	1	1	0.3	6050	6	0.05
DC	—	—	T _{0.95}	—	—	T _{0.95}	—	—	—
DC-12	1	1	1 ms	1	1	1 ms	6050	6	0.05➤
DC-13	1	1	6 x P♣	1	1	6 x P♣	6050	6	0.05➤
DC-14⌘	10	1	15 ms	1	1	15 ms	6050	—	0.05➤

I_e Rated operational current, I Current to be made or broken

U_e Rated operational voltage, U Voltage before make

PU_eI_e Steady-state power consumption (W)

T_{0.95} Time to reach 95% of the steady-state current (ms)

* See sub-clause 8.3.3.5.2.

‡ For tolerances on test quantities, see sub-clause 8.3.2.2.

§ The first 50 operating cycles shall be run at U/U_e=1.1 with the loads set at U_e.

♣ The value "6 x P" results from an empirical relationship which is found to represent most DC magnetic loads to an upper limit of P = 50 W, e.g., 6 x P= 300 W.

➤ The ON time shall be at least equal to T_{0.95}.

⌘ Where the break current differs from the make current value, the ON time refers to the make current value after which the current is reduced to the break current value for a suitable period e.g., 0.05 s.

Bulletin 700-CF, 700-CFB, 700-CFM
IEC Industrial Control Relays
 Approximate Dimensions

Approximate Dimensions are shown in millimeters (inches). Approximate Dimensions are not intended for manufacturing purposes.

Mounting Position

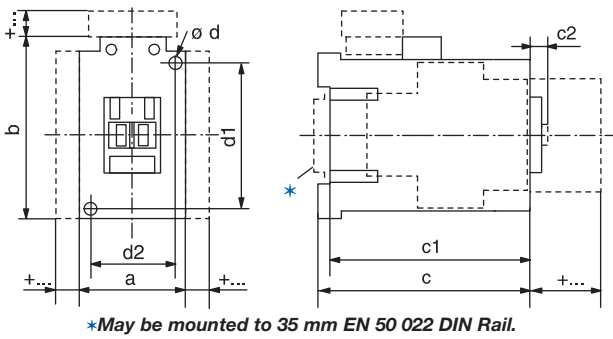

AC and DC Control Relay with DC Electronic Coil

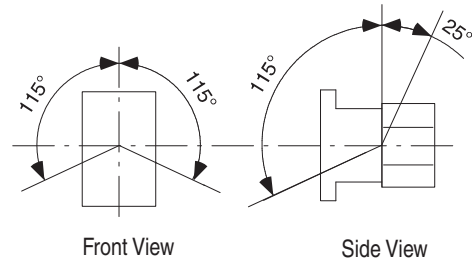

DC Control Relay

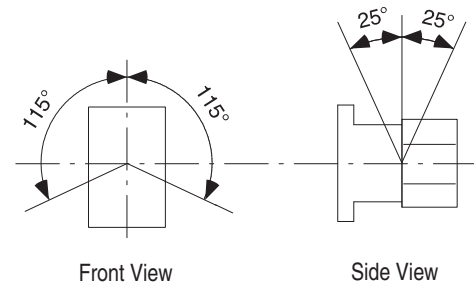

AC and DC Control Relays with 12V or 24V DC Electronic Coil

Type	a	b	c	c1	c2	Ød	d1	d2
700-CF, -CFB, -CFM	45 (1-25/32)	81 (3-3/16)	80.5 (3-11/64)	75.5 (3-3/32)	6 (1/4)	2 screws 4.5 (3/16)	60 (2-23/64)	35 (1-25/64)

DC Control Relays with 110V or 220V DC Electronic Coil

Type	a	b	c	c1	c2	Ød	d1	d2
700-CF, -CFB, -CFM	45 (1-25/32)	105 (4-1/8)	80.5 (3-11/64)	75.5 (3-3/32)	6 (1/4)	2 screws 4.5 (3/16)	60 (2-23/64)	35 (1-25/64)

DC Control Relays

Type	a	b	c	c1	c2	Ød	d1	d2
700-CF, -CFB, -CFM	45 (1-25/32)	81 (3-3/16)	106.5 (4-3/16)	101.5 (4)	6 (1/4)	2 screws 4.5 (3/16)	60 (2-23/64)	35 (1-25/64)

9

Accessories

Relay with		AC Control Relay		DC Control Relay	
		mm	(inches)	mm	(inches)
Auxiliary Contact for Front Mounting	2- or 4-pole	c/c1 + 39	(c/c1 + 1 - 37/64)	c/c1 + 39	c/c1 + 1 - 37/64
Auxiliary Contact for Side Mounting	1- or 2-pole	a + 9	(a + 23/64)	a + 9	(a + 23/64)
Pneumatic Timing Module	—	c/c1 + 58	(c/c1 + 2 - 23/64)	—	—
Solid-state Timing Module	on coil terminal side	b + 24	(b + 15/16)	b + 24	(b + 15/16)
Mechanical Latching	—	c/c1 + 61	(c/c1 + 2 - 31/64)	—	—
DC Interface	on coil terminal side	b + 9	(b + 23/64)	—	—
Surge Suppressor	on coil terminal side	b + 3	(b + 1/8)	b + 3	(b + 1/8)
Labelling with:	label sheet	+0	(+0)	+0	(+0)
—	marking tag with cover	+0	(+0)	+0	(+0)
—	marking tag carrier for System V4/V5	+5.5	(+7/32)	+5.5	(+7/32)
—	marking tag carrier for System Bull. 1492W	+5.5	(+7/32)	+5.5	(+7/32)



Bulletin 700S-CF — Safety Control Relay

The Bulletin 700S-CF Safety Control Relay provides mechanically or mirror contact performance, which are required in feedback circuits for safety applications. Bifurcated contacts are ideal for low energy feedback safety circuits where high contact reliability is required.

Features

- IEC industrial safety relay
- Mechanically linked contacts as per IEC 60947-5-1
- Third party certification SUVA
- Red cover and mechanically linked contact symbol on front face
- Gold plated, bifurcated version for low level switching applications
- Permanently fixed front mounted auxiliary contact block

Certifications

cULus Listed (File No. E14840, Guide NKCR/NKCR7)
 CE Marked
 CCC Certified

Table of Contents

Product Selection this page
 Specifications..... 9-158
 Approximate Dimensions..... 9-160

Standards Compliance

EN/IEC 60947-1, -5-1
 UL 508
 CSA C22.2 No. 14
 Meets the material restrictions for European Directive 2002/95/EC - EU-RoHS

Product Selection

Type CF and CFB Safety Control Relays — 8-Pole AC Coil Voltage (Ratings for 700S-CF Only)

	AC-12		AC-15							Connection Diagrams		Contacts		Standard Contacts (Main) Gold-Plated Bifurcated (Front) Cat. No.	Gold-Plated Bifurcated, All Contacts Cat. No.*
	I_{th} [A]		I_e [A]							Main Contacts	Auxiliary Contacts	N.O.	N.C.		
	40 °C	60 °C	24/48V	120 V	240 V	400 V	500 V	600 V	690 V						
Main Contacts	20	20	10	10	10	6	2.5	1	1			4	4	700S-CF440BC	700S-CFB440BC
Adder Deck Contacts	10	6	6	6	5	3	1.6	1	1			5	3	700S-CF530BC	700S-CFB530BC
												6	2	700S-CF620BC	700S-CFB620BC

* Ratings for Bulletin 700S-CFB are on page 9-159

⊗ AC Coil Voltage Code

The cat. no. as listed is incomplete. Select a coil voltage code from the table below to complete the cat. no. Example: **Cat. No. 700S-CF440BC** becomes **Cat. No. 700S-CF440DBC** for 120V, 60 Hz.

[V]	12	24	32	36	42	48	100	100... 110	110	120	127	200	200... 220	208	208... 240	220... 230
50 Hz	R	K	V	W	X	Y	KP	—	D	P	S	KG	L	—	—	F
60 Hz	Q	J	—	V	—	X	—	KP	—	D	—	—	KG	H	L	—
50/60 Hz	—	KJ	—	—	—	KY	KP	—	KD	—	—	KG	KL	—	—	KL

[V]	230	230... 240	240	277	347	380	380... 400	400	400... 415	440	480	500	550	600
50 Hz	—	VA	T	—	—	—	N	—	G	B	—	M	C	—
60 Hz	—	—	A	T	I	E	—	—	—	N	B	—	—	C
50/60 Hz	KF	—	KA	—	—	—	—	—	KN	—	KB	—	—	—

Type CF and CFB Safety Control Relays — 8-Pole DC Coil Voltage (Ratings for 700S-CF Only)

	AC-12		AC-15							Connection Diagrams		Contacts		Standard Contacts (Main) Gold-Plated Bifurcated (Front) Cat. No.	Gold Plated Bifurcated, All Contacts Cat. No.*		
	I_{th} [A]		I_e [A]							Main Contacts		Auxiliary Contacts				No. of N.O. Contacts	No. of N.C. Contacts
	40 °C	60 °C	24/48V	120 V	240 V	400 V	500 V	600 V	690 V	No. of N.O. Contacts		No. of N.C. Contacts					
Main Contacts	20	20	10	10	10	6	2.5	1	1			4	4	700S-CF440BC	700S-CFB440BC		
Adder Deck Contacts	10	6	6	6	5	3	1.6	1	1			5	3	700S-CF530BC	700S-CFB530BC		
												6	2	700S-CF620BC	700S-CFB620BC		

* Ratings for Bulletin 700S-CFB are on page 9-159

⊗ DC Coil Voltage Code

The cat. no. as listed is incomplete. Select a coil voltage code from the table below to complete the cat. no. Example: **700S-CFB440BC** becomes **Cat. No. 700S-CFB440ZJC** for 24V DC.

[V]	9	12	24	36	48	48...72	60	64	72	80	110	110...125	115	125	125	220	220...250	230	250
Standard	ZR	ZQ	ZJ	ZW	ZY	—	ZZ	ZB	ZG	ZE	ZD	—	ZP	ZS	ZA	—	ZF	ZT	—
Standard with diode	—	—	DJ	—	—	—	—	—	—	—	—	—	—	—	—	—	—	—	—
Electronic with diode	—	EQ	EJ	—	—	EY	—	—	—	—	—	ED	—	—	—	EA	—	—	—

Assignment of Contacts

Safety Control Relays with Front-mount Auxiliary Contacts, 8-Pole AC or DC Coil Voltage

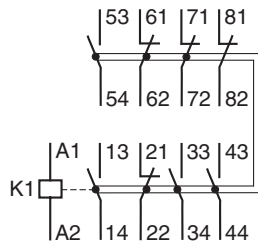

700S-CF440BC...
700S-CFB440BC...

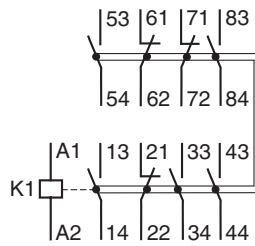

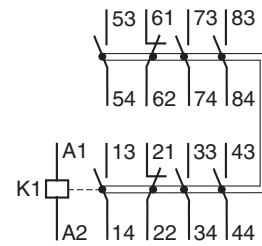

700S-CF530BC...
700S-CFB530BC...



700S-CF620BC...
700S-CFB620BC...

For general Bulletin 700S-CF specifications, refer to page 9-154

			Cat. No. 700S-CF	Aux. Contact (Front-mounted)	
Mechanical Life		[Mil]	15	15	
Electrical Life	AC-15 (240V, 3 A)	[Mil]	1.5	1.5	
Weight	AC Coil	[g]	390	—	
Terminal Cross-Sections					
Terminal Type					
Terminal Size per IEC 947-1			2 x A4	2 x A4	
	Solid/ Stranded‡	1 Conductor	[mm ²]	1.5...6	0.5...2.5
		2 Conductor	[mm ²]	1.5...6	0.75...2.5
Max. Wire Size per UL/CSA		[AWG]	16...10	18...14	
Tightening Torque		[lb•in]	13.3...22	8.9...13.3	
Tightening Torque		[N•m]	1.5...2.5	1...1.5	

‡ For 16 or more strands, end ferrule is required

DC Switching Ratings for 700S-CF Main Poles in Series (Resistive Load at 60 °C)			
	1 pole	2 poles	3 poles
24/48V	25/20 A	25 A	25 A
125V	6 A	25 A	25 A
220V	1.5 A	8 A	25 A
440V	0.4 A	1 A	3 A

IEC Industrial Control Relays

Approximate Dimensions

Approximate Dimensions are shown in millimeters (inches). Approximate Dimensions are not intended for manufacturing purposes.

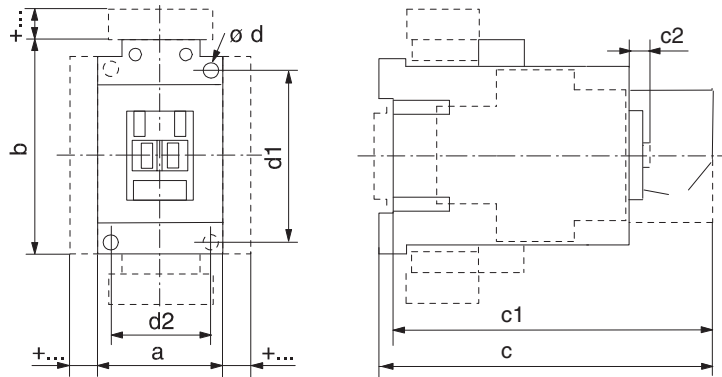

AC and DC Safety Control Relays with 12V or 24V DC Electronic Coil

Cat. No.	a	b	c	c1	c2	Ød	d1	d2
700S-CF	45	81	119.5	114.5	6	2 - 4.5	60	35
	(1-25/32)	(3-3/16)	(4-3/4)	(4-43/64)	(1/4)	(2 - 3/16)	(2-23/64)	(1-25/64)

DC Safety Control Relays with 110V or 220V DC Electronic Coil

Cat. No.	a	b	c	c1	c2	Ød	d1	d2
700S-CF	45	105	119.5	114.5	6	2 - 4.5	60	35
	(1-25/32)	(4-1/8)	(4-3/4)	(4-43/64)	(1/4)	(2 - 3/16)	(2-23/64)	(1-25/64)

DC Safety Control Relays

Cat. No.	a	b	c	c1	c2	Ød	d1	d2
700S-CF	45	81	145.5	140.5	6	2 - 4.5	60	35
	(1-25/32)	(3-3/16)	(5-49/64)	(5-37/64)	(1/4)	(2 - 3/16)	(2-23/64)	(1-25/64)

Accessories

Safety Control Relays with	mm	[in.]
Auxiliary contact block for side mounting 1- or 2-pole	a + 9	(a + 23/64)
Electronic Timing Module on coil terminal side	b + 24	(b + 15/16)
Interface Module on coil terminal side	b + 9	(b + 23/64)
Surge Suppressor on coil terminal side	b + 3	(b + 1/8)
Labeling with label sheet	+ 0	(+ 0)
Marking tag sheet with clear cover	+ 0	(+ 0)
Marking tag adapter for System Bul. 1492W	+ 5.5	(+ 7/32)

Mounting Position

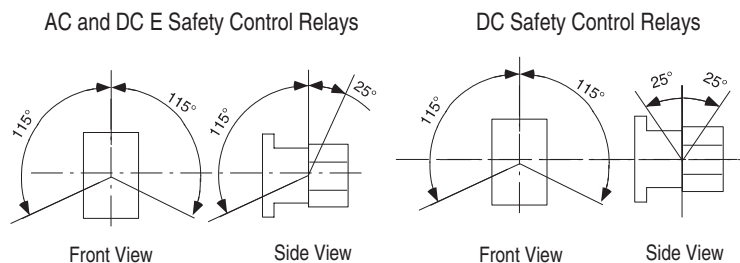

Safety Relay Circuit With 5 Safety Outputs

- Use for E-stop control. E-stop will work properly if any one fault occurs (a fault could be one welded contact or one undesired open connection such as a loose wire).
- High output switching capability and long contact life.
- Circuit complies with EN 954 categories 1, 2, 3, 4.
- Helps prevent restart of the 5 safety outputs if there is a single fault anywhere in the system.
- Use (3) 700S-CF relays and this diagram to construct the circuit

Basic Circuit

(1) Output Circuit (3 Relays, 9 Terminal Blocks)

Basic Circuit

(1) Output Circuit (3 Relays, 9 Terminal Blocks)

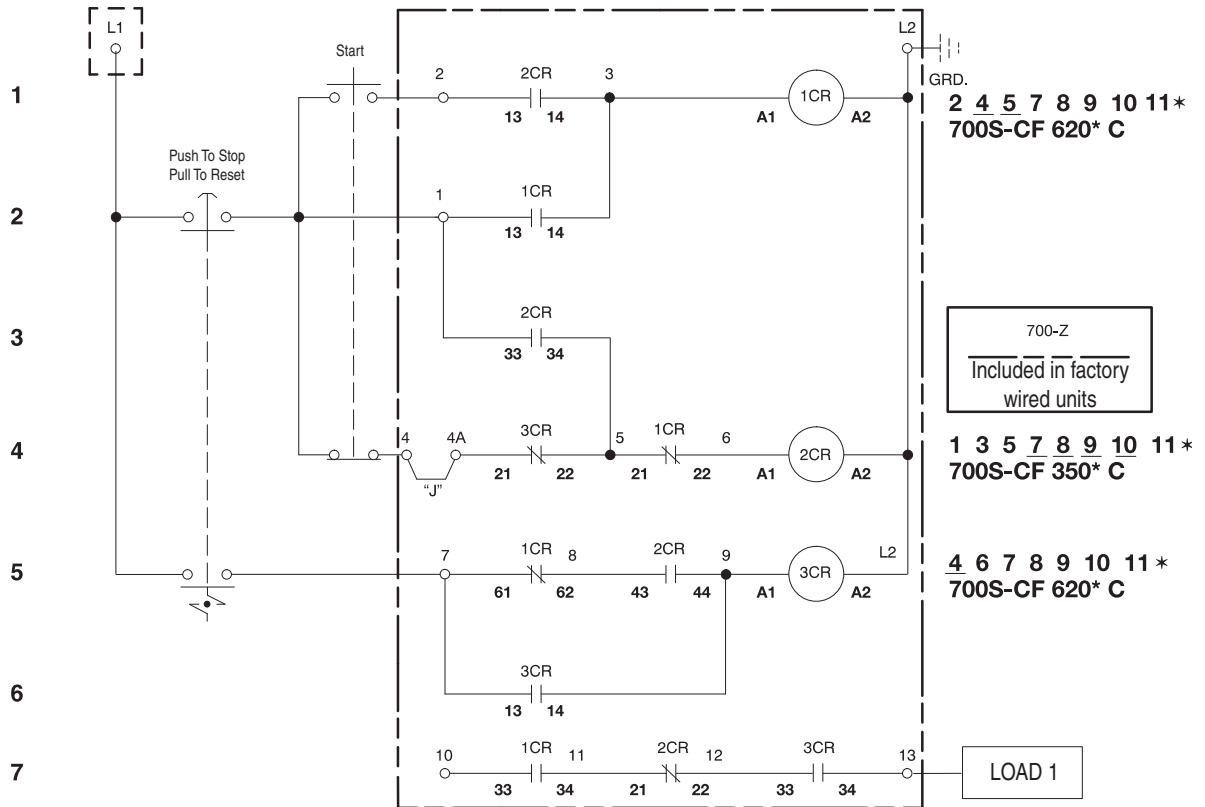

(5) Output Circuit (3 Relays, 17 Terminal Blocks)

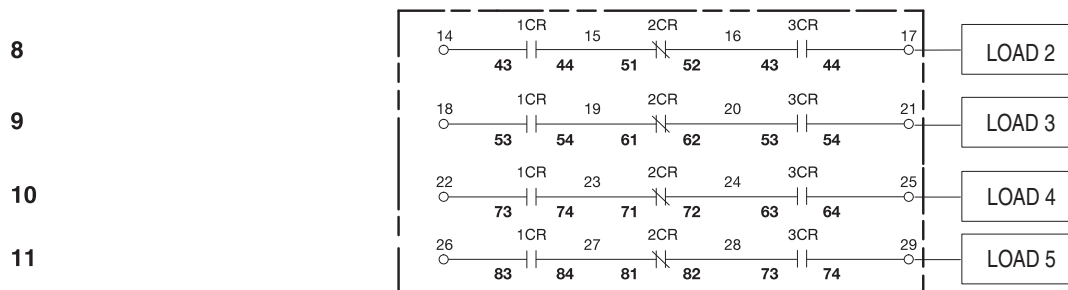

* Numbers shown are the line numbers where the contacts for this relay appear.
 Contact your local Rockwell Automation sales office or Allen-Bradley distributor for availability.



Bulletin 700-K — Miniature Control Relays

- IEC compact industrial relay
- IP2X Finger Protection
- Bifurcated contacts for low-level signals
- Optional integrated coil protection diode

Certifications

cULus Listed (File No. E33916,
Guide NKCR/NKCR7)
CE Marked
CCC

Table of Contents

Product Selection this page
Accessories..... 9-164
Specifications..... 9-165

Standards Compliance

UL 508
CSA C22.2 No. 14
EN/IEC 60947-1, -5-1
Meets the material restrictions
for European Directive
2002/95/EC - EU-RoHS

4-Pole AC or DC Coil Voltage

AC-12		AC-15 (B600)							Connection Diagrams	Contacts		Pkg. Qty. *	Screw Type Terminals Cat. No.	Spring Clamp Terminals Cat. No.
I_{th} [A]		I_e [A]								N.O.	N.C.			
40 °C	60 °C	24/48V	120V	240V	400V	500V	600V	690V						
10	6	3	3	2	1	1	0.6	0.6		4	0	1	700-K40E-⊗	700-KR40E-⊗
										3	1	1	700-K31Z-⊗	700-KR31Z-⊗
										2	2	1	700-K22Z-⊗	700-KR22Z-⊗
										1+1L*	1+1L*	1	700-KL22Z-⊗	700-KRL22Z-⊗

* May be ordered in package quantities of 20. Add letter **M** to the end of the cat. no. Example: **700-K40E-ZJM**.

⊗ Coil Voltage Codes

The cat. no. as listed is incomplete. Select a coil voltage code from the table below to complete the cat. no. Example: 230V, 50/60 Hz: **Cat. No. 700-K40E-⊗** becomes **Cat. No. 700-K40E-KF**. For other voltages, consult your local Rockwell Automation sales office or Allen-Bradley distributor.

For Screw Type Terminal Versions

[M]	12	24	110	120	125	220	230	240	250	400	440	480	525	600
AC, 50 Hz	—	—	D	—	—	—	—	—	—	—	B	—	VC	—
AC, 60 Hz	—	—	—	D	—	—	—	—	—	—	—	B	—	VC
AC, 50/60 Hz	—	KJ	—	—	—	—	KF	KA	—	KN	—	—	—	—
Standard	ZQ	ZJ	ZD	—	ZS	ZA	—	—	ZT	—	—	—	—	—
Standard diode	—	DJ	—	—	—	—	—	—	—	—	—	—	—	—

For Spring Clamp Type Terminal Versions

AC, 50 Hz	—	—	D	—	—	—	—	—	—	—	—	—	—	—
AC, 60 Hz	—	—	—	D	—	—	—	—	—	—	—	—	—	—
AC, 50/60 Hz	—	KJ	—	—	—	—	KF	—	—	—	—	—	—	—
Standard	—	ZJ	ZD	—	—	—	—	—	—	—	—	—	—	—
Standard diode	—	DJ	—	—	—	—	—	—	—	—	—	—	—	—



Assignment of Contacts

Device Combinations in Accordance with IEC 60947-1 / -4-1

Table valid for : AC / DC = 0.85...1.1 x U_s , $T_{amb.} = -25\text{ }^{\circ}\text{C} \dots +60\text{ }^{\circ}\text{C}$, normal position (horizontal rail mounting). Also valid for Bulletin 700-KR relays and Bulletin 100-KR auxiliary contacts. *





Auxiliary Contact Blocks		Control Relays 700-K (AC and DC Control)				
Circuit Diagram	Control	700-K22Z-⊗	700-K31Z-⊗	700-K40E-⊗	700-KL22Z-⊗	
Front Mounting						
100-KFA02E		AC/DC	—	31Z + 02E = 33Y *	40E + 02E = 42Y	—
100-KFA11E		AC/DC	22Z + 11E = 33Y	31Z + 11E = 42Y	40E + 11E = 51Y	L22Z + 11E = L33Y
100-KFA20E		AC/DC	22Z + 20E = 42Y	31Z + 20E = 51Y	40E + 20E = 60Y	L22Z + 20E = L42Y
100-KFA04E		AC/DC	—	—	40E + 04E = 44Y *	—
100-KFA13E		AC/DC	—	31Z + 13E = 44Y *	40E + 13E = 53Y	—
100-KFA22Z		AC/DC	—	31Z + 22Z = 53Y *	40E + 22Z = 62Y	—
100-KFA31Z		AC/DC	—	—	40E + 31Z = 71Y ‡	—
100-KFA40E		AC/DC	22Z + 40E = 62Y	31Z + 40E = 71Y	40E + 40E = 80Y	L22Z + 40E = L62Y

* For other operating limits, please contact our technical consultant.

* $T_{amb.}$ max. +40 °C



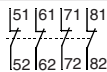
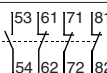
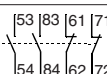
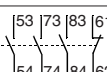
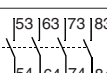

‡ $T_{amb.}$ max. +40 °C and only allowed for coil voltage 24V DC or 230V AC

Auxiliary Contact Blocks

	Description	Connection Diagrams			For Use With	Pkg. Qty. *	Screw Type Terminals	Spring Clamp Terminals
			N.O.	N.C.			Cat. No.	Cat. No.
	Front-mounted auxiliary contacts <ul style="list-style-type: none"> Auxiliary Contact Blocks 2- and 4-pole versions Choice of contact configurations Snap on, no tools required Electronic-compatible bifurcated contacts for signals down to 15V/2 mA 		0	2	100/104-K, 700-K	1	100-KFA02E	100-KRFA02E
			1	1	100/104-K, 700-K	1	100-KFA11E	100-KRFA11E
			2	0	100/104-K, 700-K	1	100-KFA20E	100-KRFA20E
		0	4	100/104-K, 700-K	1	100-KFA04E	100-KRFA04E	
		1	3	100/104-K, 700-K	1	100-KFA13E	100-KRFA13E	
		2	2	100/104-K, 700-K	1	100-KFA22Z	100-KRFA22Z	
		3	1	100/104-K, 700-K	1	100-KFA31Z	100-KRFA31Z	
		4	0	100/104-K, 700-K	1	100-KFA40E	100-KRFA40E	

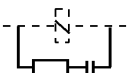
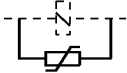

* May be ordered in package quantities of 10. Add letter **M** to the end of the cat. no. Example: **100-KFA02EM**.

Control Modules

	Description	Connection Diagrams	For Use With	Pkg. Qty.	Cat. No.	
	Mechanical Interlock <ul style="list-style-type: none"> For interlocking of two adjacent contactors No added width to contactor assembly Front mount plug-in type Optional auxiliary contact blocks and suppressor modules mount onto the interlock 		100-K, 700-K (AC & DC Control)	1	100-KMCH	
	Surge Suppressor <ul style="list-style-type: none"> Plug-in type Limits surge voltage on coil drop-off 		100/104-K, 700-K	1 *	100-KFSC50	
				1 *	100-KFSC280	
				1 *	100-KFSC480	
			MOV Suppressor	100/104-K, 700-K	1 *	100-KFSV55
					1 *	100-KFSV136
	Diode Suppressor	100/104-K, 700-K	1 *	100-KFSD250		

* May be ordered in package quantities of 10. Add letter **M** to the end of the cat. no. Example: **100-KFSC50M**.

Marking Systems

	Description	Pkg. Qty.	Cat. No.
	Label Sheet 105 self-adhesive paper labels each, 6 x 17 mm	10	100-FMS
	Snap-In Marker Card	5	1492-M6X12



IEC Specifications

			700-K	700-KR
AC-12 Rated Thermal Current				
Ambient temperature 40°C				
I_{th}	24...240V	[A]	10	
	230...500V	[A]	10	
	230...690V	[A]	10	
Ambient temperature 60°C				
I_{th}	24...240V	[A]	6	
	230...500V	[A]	6	
	230...690V	[A]	6	
AC-15/B600				
Switching of Solenoids and contactors				
I_e	24V	[A]	3	
	48V	[A]	3	
	120V	[A]	3	
	230V	[A]	2	
	240V	[A]	2	
	400V	[A]	1.2	
	480V	[A]	1	
	500V	[A]	1	
	600V	[A]	0.6	
	690V	[A]	0.6	
Short-circuit Protection				
"gG" Fuse acc. to IEC 60947-5-1, no welding of contacts				
	Fuse gG	[A]	10	
Min. Switching Capacity 15V				
For bifurcated contacts (control relays and auxiliary contact blocks)				
		[mA]	2	
Resistance and Power Dissipation				
Main current circuit resistance, 1 pole		[mΩ]	6.5	
Power dissipation, 4 poles		[W]	2.6	
Total power dissipation				
	AC control, warm	[W]	4.4	
	DC control, warm	[W]	5.2	
Lifespan				
Mechanical		[Mio. op.]	15	
Electrical AC-15 (240V / 2 A)		[Mio. op.]	0.7	
Weight				
	AC control	kg (lbs.)	0.16 (0.35)	
	DC control	kg (lbs.)	0.2 (0.44)	
Load Carrying Capacity per UL/CSA				
Rated voltage	AC	[V]	max. 600	
Continuous rating	40 °C	[A]	10	6
Switching capacity	AC	[A]	B 600	
Rated voltage	DC	[V]	max. 600	
Switching capacity	DC	[A]	Q 600	

Bulletin 700-K
IEC Industrial Control Relays
 Specifications

			700-K
DC-13/Q600			
1 pole	24V	[A]	2.3
	48V	[A]	1
	110V	[A]	0.55
	125V	[A]	0.55
	220V	[A]	0.27
	250V	[A]	0.27
	400V	[A]	0.15
	440V	[A]	0.15
	600V	[A]	0.1

Cross Sections

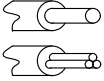
Conductor Cross Sections - Main Contacts, Auxiliary Contacts, and Coil Terminals				700-K	700-KR
Terminal type					
	Fine stranded with ferrule	(1) Conductor (2) Conductors	[mm ²] [mm ²]	0.75...2.5 0.75...2.5	0.50...2.5 0.50...2.5
	Solid or coarse stranded	(1) Conductor (2) Conductors	[mm ²] [mm ²]	1...4 1...2.5 + 1...4	0.75...2.5 § 0.75...2.5 §
Recommended torque			[Nm]	1.2	—
Cross section per UL/CSA			[AWG]	18...12 *	18...14 §
Recommended torque			[lb-in]	10.6	—

- * Pozidriv No. 2 / Blade No. 3 screw
- * Use same cross sections
- § Stranded wire only

Coil Data

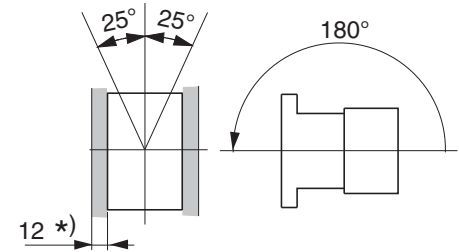
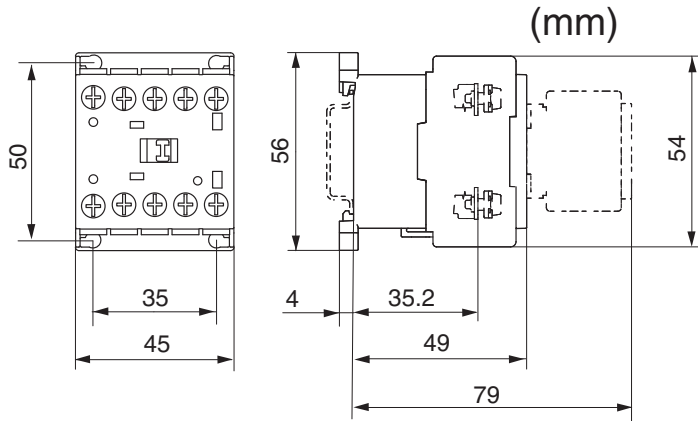

			700-K
Operating Limits			
AC control 50 Hz, 60 Hz, 50/60 Hz	pick-up	[x U _s]	0.85...1.1
	dropout	[x U _s]	0.2...0.75
DC control	pick-up	[x U _s]	0.8...1.1 9, 12, 24, 110V DC: 0.7...1.25
	dropout	[x U _s]	0.1...0.75
Coil Consumption			
AC control 50 Hz, 60 Hz, 50/60 Hz	pick-up	[VA/W]	35/32
	hold-in	[VA/W]	5/1.8
DC control	pick-up	[W]	cold 3.0, warm 2.6
	hold-in	[W]	cold 3.0, warm 2.6
Operating Times			
AC	closing delay	[ms]	15...40
	opening delay	[ms]	15...33
With RC module	opening delay	[ms]	15...28
DC	closing delay	[ms]	18...40
	opening delay	[ms]	6...12
With integrated diode	opening delay	[ms]	8...12
With external diode	opening delay	[ms]	35...50

Approximate Dimensions are shown in millimeters. Approximate Dimensions are not intended for manufacturing purposes.



*) -Minimum distance to grounded parts or walls

Bulletin 700
Solid-State Relays
 Product Overview

					
Bulletin No.	700-SA		700-SC		700-SE
Type	Tube Base, Socketed		Miniature, Ice Cube Socketed		Flat Pack
Features	Compatible with 700-HN100, 125,108, and 204 socket, LED status, zero-cross switching		Compatible with 700-HN103 or 128 socket, LED Status & Zero-cross AC Switching Options		Panel/DIN Mount, Low Profile
Load Type	AC (47...63 Hz)	DC	AC (47...63 Hz)	DC	AC (47...63 Hz)
Load Voltage Range	75...264V AC	3...125V DC	75...264V AC	3...52.8V DC or 3...125V DC	75...264V AC
Load Current Max. (Continuous)	5 A	3 A	3 A	3A @ 48V DC or Z 2A @ 110V DC	5 A/20 A*
Max. Leakage Current to Load	5 mA @ 100V, 10 mA @ 200V	5 mA @ 125V	5 mA @ 100V AC	10 mA @ 200V AC, 5 mA @ 50V DC or 0.1mA @ 100V DC	5 mA @ 100V, 10 mA @ 200V
Zero Cross Load Switching	Yes	Not Applicable	Yes (optional)	Not Applicable	Yes (optional)
Equivalent Electromechanical Relay Contact Arrangement	Form A		Form A		Form A
Rated Control (Input) Voltage	5...24V DC		5...24V DC, 100...110V AC, 200/220V AC	5...24V DC	5V DC, 12V DC, 24V DC
LED Indicator	Yes		Yes (optional)	Yes (optional for 48V DC)	No
Mounting Method	Panel or DIN with socket		Panel or DIN with socket		Panel without heat sink, Panel or DIN with heat sink
Dielectric Strength	1500V AC, 50/60 Hz, 1 min.		1500V AC, 50/60 Hz, 1 min.		2000V AC, 50/60 Hz, 1 min.
Certification	cURus, CE, VDE		cURus, CE, VDE		cURus, CE, TÜV
Max. Ambient Operating Temperature	-30...80 °C, (no condensation)		-30...80 °C (no condensation)		-30...80 °C (no condensation)
Product Selection	page 9-170		page 9-174		Web†

* With heat sink.

† Information for this product line is available on the Industrial Controls Catalog website: www.ab.com/catalogs.

Bulletin No.	700-SF		700-SH	700-SK			
Type	Square Base, Socketed		Hockey Puck	Slim Line, Socketed			
Features	Compatible with 700-HN116 socket, LED status, zero-cross AC switching		Panel/DIN Mount, High Current, Protective Cover, LED Status	Compatible with 700-HN121 socket. Supports Input (sensor) module or Output (SSR) module			
Load Type	AC (47...63 Hz)	DC	AC (47...63 Hz) 3...60V DC	Output Module		Input Module	
				AC (47...63 Hz)	DC	AC (47...63 Hz)	DC
Load Voltage Range	75...264V AC	3 ... 52.8V DC	3...50V DC, 24...265V AC 42...530V AC, 42...265V AC, 42...660V AC	75 ... 264V AC	4 ... 60V DC, 40 ... 200V DC	Field Input: 60... 264V AC	Field Input: 6.6... 32V DC
Load Current Max. (Continuous)	3 A		10 A/100 A*	2 A	2A @ 60V, 1.5A @ 200V	Supply Current: 0.1 ... 100 mA	Supply Current: 0.1 ... 100 mA
Max. Leakage Current to Load	5mA @ 100V AC, 10mA @ 200V AC	5mA @ 50V DC	<3 mA	1.5 mA	1 mA	5 µA	5 µA
Zero Cross Load Switching	Yes	Not Applicable	Yes	Yes (optional)	N/A	No	N/A
Equivalent Electromechanical Relay Contact Arrangement	Form A		Form A	Form A			
Rated Control (Input) Voltage	4V DC or 24V DC		3...32V DC, 4...32V DC, 80...130V AC, 20...260V AC 20...280V AC/22...48V DC	5 ... 24 V DC	5 ... 24 V DC	5 ... 24V DC	5 ... 24V DC
LED Indicator	Yes		Yes	Yes			
Mounting Method	Panel or DIN with socket		Panel without heat sink, Panel or DIN with heat sink	Panel or DIN with socket			
Dielectric Strength	1500V AC, 50/60 Hz, 1 min.		>4000V AC RMS	4000V AC, 50/60 Hz, 1 min.			
Certification	cURus, CE, VDE		cURus, CE, CSA	cURus, CE, TÜV			
Max. Ambient Operating Temperature	-30...80 °C (no condensation)		-20...70 °C (no condensation)	-30...80 °C (no condensation)			
Page Number	page 9-179		page 9-183	page 9-191			

* With heat sink



Bulletin 700-SA — Tube Base Relay







- 5 A (resistive) max. continuous load (output) current
- 264V AC or 125V DC max. load voltage options
- Photocoupler isolation between control and load voltage
- LED indicator (standard) for input/logic ON/OFF status monitoring
- 700-HN100, -HN125, -HN 202, or -HN108 specialty socket compatible
- 700-HT2 timing module

Table of Contents

Product Selection this page
 Accessories..... 9-171
 Specifications..... 9-172
 Approximate Dimensions..... 9-173
Standards Compliance and Certifications
 See page 9-185.

Product Selection

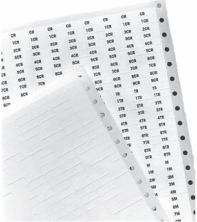
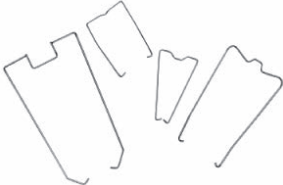
	Input-to-Output Isolation Method	Zero Cross Function	Status Indicator	Output (Load) Max. Continuous Current and Rated Voltage Range	Rated Input (Control) Voltage	Cat. No.
	Photocoupler	Yes	Yes	5 A @ 100...240V AC (47...63 Hz)	5...24V DC	700-SAZY5Z25
		Not Applicable		3 A @ 5...110V DC		700-SANY3Z25

	Description	Pkg. Quantity	Cat. No.
	Screw Terminal Tube Base Socket — Panel or DIN Rail Mounting; Guarded Terminal Construction. 8-Pin for use with DPDT Bulletin 700-HA Relays.	10	700-HN100
	Specialty Socket 8-pin backwired socket with solder terminals	10	700-HN108
	Screw Terminal Tube Base Socket — Panel or DIN Rail Mounting; Open Style Construction. 8-Pin for use with DPDT Bulletin 700-HA Relays. No retainer clip required.	10	700-HN125
	DIN (#3) symmetrical hat rail 35 x 7.5 x 1 m	10	199-DR1
	Pre-Printed Identification Tags — contains 10 sheets of pre-printed and blank tags. Each sheet contains 13 sets of the markings CR...9CR, TR...9TR, M...9M, F, R, 1S, and 117 blank tags. Tags are peel-off with sticky backing for easy placement on relays.	10	700-N40
	Blank Identification Tags — contains 10 sheets of blank identification tags for customer specialized printing. Each sheet contains 546 blank tags. Tags are peel-off with sticky backing for easy placement on relays.	10	700-N41
	Retainer Clip for Sockets with 700-SA AND 700-HB Relays. Secures relay in socket.	10	700-HN158
	8-Pin Socket — Can Be Used With or Without Timing Module or Surge Suppressor. Screw Terminal Tube Base Sockets — panel or DIN Rail mounting. Guarded terminal construction. Used with DPDT Bulletin 700-HA Relays.	10	700-HN204

Control/Input Ratings

Cat. No.	Rated Control Voltage	Max. Operating Control Voltage Range	Max. Reverse Control Voltage	Impedance	Control Voltage Levels	
					Pick-up Voltage	Drop-out Voltage
700-SAZY5Z25	5...24V DC	4...32V DC	-32V DC	15 mA max.*	4V DC max.	1V DC min.
700-SANY3Z25		4...30V DC	-30V DC	1.5 kΩ (+20% -10%)		

Load/Output Ratings

Cat. No.	Rated Load Voltage	Maximum Load Voltage Range	Continuous Load Current (Resistive) [A]		Max. Inrush Current‡
			Min.	Max*§	
700-SAZY5Z25	100...240V AC	75...264V AC	0.1	5.0	80 A, @ 50/60 Hz for 1 cycle
700-SANY3Z25	5...110V DC	3...125V DC	0.1	3.0	12 A (10 ms)

Characteristics

Description	Cat. No. 700-SAZY5Z25	Cat. No. 700-SANY3Z25
Load Switching Method/Device	Triac	Transistor
Pick-up Time	1/2 cycle of load power source cycle time§ + 1 ms max.	0.5 ms max.
Drop-out Time	1/2 cycle of load power source cycle time§ + 1 ms max.	2.5 ms max.
Output ON Voltage Drop	1.6V (RMS) max.	1.5V max.
Output Leakage Current	5 mA max. (at 100V AC); 10 mA max. (at 200V AC)	5 mA max. (at 125V DC)
Output V _{DRM} V _{CEO} (V)	600	150
Output di/dt (A/uS)	50	—
Output dv/dt (V/uS)	500	—
Output I ² t (A ² S)	41.6	—
Output T _j (°C) Max.	125	150
Insulation Resistance	100 MΩ min. (at 500V DC)	
Dielectric Strength	1500V AC, 50/60 Hz for 1 min	
Vibration Resistance (Max.)	10...55 Hz, 1.5 mm double amplitude (10 G)	
Shock Resistance (max.)	1000 m/s ² (100 G)	
Ambient Temperature	Operating	-30...80 °C (-22...176 °F) with no icing or condensation
	Storage	-30...100 °C (-22...212 °F) with no icing or condensation
Ambient Humidity	45...85% (no condensation)	
Standards Compliance	UL 508, CSA C22.2 No. 14, EN 60947-1, -4-3	
Certifications	cURus Recognized (File No. E96956, Guide NMFT2/NMFT8), CE Marked, VDE Certified	
Weight	Approx. 70 g	

* With constant current input system. SSR input impedance varies with a change in input (control) voltage.

§ Refer to the following graph "Load Current vs. Ambient Temperature Characteristics" for additional load current details.

‡ If the SSR operation is continuous ON/OFF, this value should be reduced by 50%. Refer to "Inrush Current Resistivity" graph below.

§ 60 Hz full cycle time = 16.6 ms, 50 Hz full cycle time = 20 ms.

9

Load Current vs. Ambient Temperature Characteristics

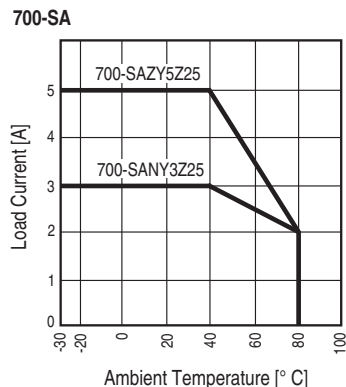

Inrush Current Resistivity*

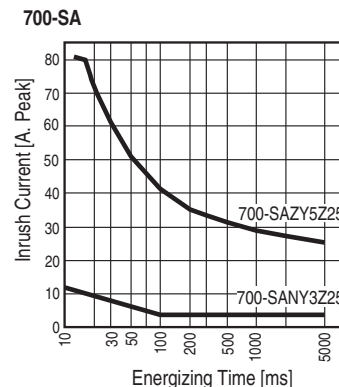

* Inrush current resistivity is the ability of an SSR to withstand a large surge current for a short period of time. Surges are considered non-repetitive (max. repeatability once every 5 seconds). Keep the inrush current to half the rated value if it occurs repetitively. Exceeding the non-repetitive inrush current will damage the SSR.



Terminal Arrangement (Bottom View)

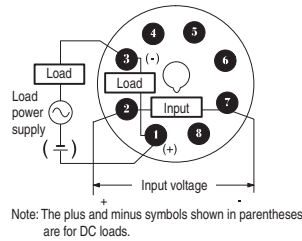

Basic Application Considerations

High Density Mounting of Multiple SSRs

If multiple SSRs are installed side-by-side be aware that the outer case wall of the SSR serves to dissipate heat. Install the relays so that they are adequately ventilated. If poor ventilation is unavoidable, reduce the load current to half.

Protective Component

When controlling AC inductive loads, connect an inrush/surge absorbing device (varistor) across the SSR load terminals. If the SSR has built-in surge suppression (Bulletins 700-SE and 700-SH) and additional surge suppression is required, connect the varistor across the terminals of the load device. Select a varistor that meets the conditions of the load voltage outlined in the table below.

Load Voltage	Varistor Voltage [V]	Varistor Surge Resistance
100...120V AC	240...270	1000 A min.
200...240V AC	440...470	
380...480V AC	820...1000	

Note: For additional details applying solid-state relays, refer to pub. 700-AT001*, Solid-State Relay Application Guide.

For a DC inductive load, a diode should be connected parallel to the load to absorb the counter electromotive force (OFF) of the load.

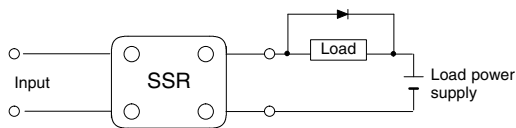

EMC Directive Compliance

1. AC-switching models comply with EMC Directives under the following conditions:

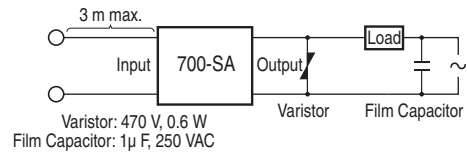

- Connect a varistor between the output terminals.
- Connect a film capacitor to the load power supply.
- The input cable must be less than 3 m.

2. DC-switching models comply with EMC Directives under the following conditions:

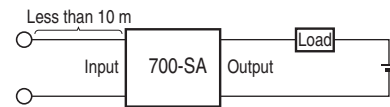

- The input cable must be less than 10 m.

Approximate Dimensions

All units in millimeters unless otherwise indicated. To convert millimeters to inches multiply by 0.0394. Dimensions are not intended to be used for manufacturing purposes.

Bul. 700-SA*

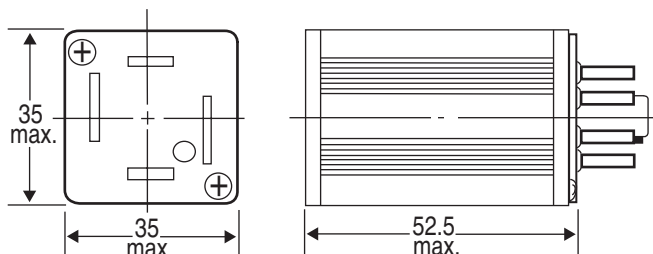

* Bulletin 700-SA is compatible with Cat. Nos. 700-HN100, -108, -125, and -204 (sockets).



Bulletin 700-SC — Ice Cube Relay

- 3 A (resistive) max. continuous load (output) current
- 264V AC, 48V DC or 125V DC max. load voltage options
- 5...24V DC or 110/220V AC control (input) voltage options
- LED indicator (optional) for input/logic On/Off status monitoring
- Bulletins 700-HN103, 700-HN104, or 700-HN128 socket compatible
- Compatible with Bulletins 700-AT1 or 700-AT2 timer module





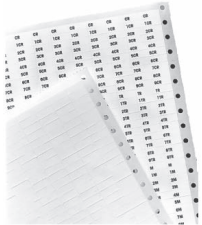
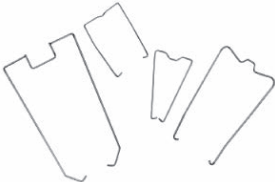

Table of Contents

Product Selection this page
 Accessories..... 9-175
 Specifications..... 9-176
 Approximate Dimensions..... 9-178
Standards Compliance and Certifications
 See page 9-176.

Product Selection

	Input-to-Output Isolation Method	Zero Cross Function	Status Indicator	Output (Load) Max. Continuous Current and Rated Voltage Range	Rated Input (Control) Voltage	Cat. No.
	Photocoupler	Yes	Yes	3 A @ 100...240V AC*	5...24V DC	700-SCZY3Z25
				2 A @ 100...240V AC*	100/110V AC	700-SCZY2A1
		200/220V AC		700-SCZY2A2		
	Phototriac	No		3 A @ 100...240V AC*	24V DC	700-SCTY3Z24
	Photocoupler	Not Applicable	No	3 A @ 4...48V DC	5...24V DC	700-SCNY3Z25
				Yes	4...24V DC	700-SCZN3Z26
	Phototriac	No		3 A @ 100...240V AC*	24V DC	700-SCTN3Z24
	Photocoupler	Not Applicable		3 A @ 4...48V DC	4...24V DC	700-SCNN3Z26
				2 A @ 5...110V DC	5...24V DC	700-SCNN2Z25

* 47...63 Hz

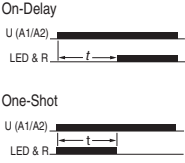
	Description	Pkg. Quantity	Cat. No.	
	Screw Terminal Socket — Panel or DIN Rail Mounting; Guarded Terminal Construction. $I_{th} = 10$ A per pole. 14-blade miniature socket for use with Bulletin 700-SC Relays.	10	700-HN103	
	Screw Terminal Socket — Panel or DIN Rail Mounting; Guarded Terminal Construction $I_{th} = 10$ A per pole. 14-blade miniature socket for use with Bulletin 700-SC relays. This socket has coil and contact separation as well as the ability to plug in optional plug in modules (700-A__ accessories: LED, Surge Suppression, Timing Modules)	10	700-HN104	
	Screw Terminal Base Socket — Panel or DIN Rail Mounting; Open-Style Construction $I_{th} = 10$ A per pole. 14-blade miniature socket for use with Bulletin 700-SC Relays.	10	700-HN128	
	DIN (#3) symmetrical hat rail 35 x 7.5 x 1 m	10	199-DR1	
	Pre-Printed Identification Tags — contains 10 sheets of pre-printed and blank tags. Each sheet contains 13 sets of the markings CR...9CR, TR...9TR, M...9M, F, R, 1S, and 117 blank tags. Tags are peel-off with sticky backing for easy placement on relays.	10	700-N40	
	Blank Identification Tags — contains 10 sheets of blank identification tags for customer specialized printing. Each sheet contains 546 blank tags. Tags are peel-off with sticky backing for easy placement on relays.	10	700-N41	
	Retainer Clip for Cat. Nos. 700-HN103, -HN104 and -HN128 Sockets with 700-HC Relays. Secures relay in socket.	10	* 700-HN114	
	Timing Module On-Delay or One-Shot selectable voltage range: 12...24V AC/DC used with sockets that accept plug-in accessory modules.		1	700-AT3
	Timing Module On-Delay or One-Shot selectable voltage range: 110...125V AC used with sockets that accept plug-in accessory modules.		700-AT3A1	
	Timing Module On-Delay or One-Shot selectable voltage range: 230...240V AC used with sockets that accept plug-in accessory modules.		700-AT3A2	

* Series B retainer clip must be used with Bulletin 700-SC.

Bulletin 700-SC
Solid-State Relays
 Specifications

Control/Input Ratings

Cat. No.	Rated Control Voltage	Max. Operating Control Voltage Range	Max. Reverse Control Voltage [V]	Impedance	Control Voltage Levels	
					Pick-up Voltage	Drop-out Voltage
700-SCZY3Z25	5...24V DC	4...28V DC	-28.8	15 mA max. *	4V DC max.	1V DC min.
700-SCZY2A1	100/110V AC	75...125V AC	NA	41 kΩ± 20%	75V AC max.	20V AC min.
700-SCZY2A2	200/220V AC	150...250V AC	NA	72 kΩ± 20%	150V AC max.	40V AC min.
700-SCTY3Z24	24V DC	19.2...28.8V DC	-28.8	2 kΩ± 20%	19.2V DC max.	1V DC min.
700-SCNY3Z25	5...24V DC	4...28V DC	-28	1.5 kΩ +20%/ -10% ‡	4V DC max.	
700-SCZN3Z26	4...24V DC	3...28V DC	-28.8	15 mA max. *	3V DC max.	
700-SCTN3Z24	24V DC	19.2...28.8V DC	-28.8	2 kΩ± 20%	19.2V DC max.	
700-SCNN3Z26	4...24V DC	3...28V DC	-28	1.5 kΩ +20%/ -10% ‡	3V DC max.	
700-SCNN2Z25	5...24V DC		-28.8			

Load/Output Ratings

Cat. No.	Rated Control Voltage	Max. Load Voltage Range	Continuous Load Current (Resistive) [A]		Max. Inrush Current †			
			Min.	Max. §				
700-SCZY3Z25	100...240V AC	75...264V AC	0.1	3	45 A (@50/60 Hz, 1 cycle)			
700-SCTY3Z24								
700-SCZN3Z26			0.1	2				
700-SCTN3Z24								
700-SCZY2A1			4...48V DC	3...52.8V DC		0.1	3	18 A (10 ms)
700-SCZY2A2								
700-SCNN3Z26	5...110V DC	3...125V DC	0.1	2	10 A (10 ms)			

* With constant current input circuit system. SSR impedance varies with a change in input (control) voltage.

‡ Input impedance attains its maximum at the operating voltage.

† If the SSR operation is continuous ON/OFF, this value should be reduced by 50%. Refer to "Inrush Current Resistivity" graphs on page 9-177 for details.

§ Refer to the following "Load Current Versus Ambient Temperature Characteristics" graphs on page 9-177 for additional load current details.

Characteristics

Description	Cat. No. 700-SCZ...	Cat. No. 700-SCT	Cat. Nos. 700-SCNY, 700-SCNN3...	Cat. Nos. 700-SCNN2...
Load Switching Method/Device	Triac		Transistor	
Pick-up time	1/2 of load power source cycle time ♣ + 1 ms max. (DC input) 3/2 of load power source cycle time ♣ + 1 ms max. (AC input)	1 ms max	0.5 ms max.	0.5 ms max.
Drop-out time	1/2 of load power source cycle time ♣ + 1 ms max. (DC input) 3/2 of load power source cycle time ♣ + 1 ms max. (AC input)	1/2 of load power source cycle time ♣ + 1 ms max	2 ms max.	2.5 ms max.
Output On Voltage Drop	1.6 V (RMS) max.	1.6 V (RMS)	1.5 V max.	1.5 V max.
Output Leakage Current	5 mA max (@ 100 V AC) 10 mA max (@ 200 V AC)	2.5 mA max (@ 100 V AC) 5 mA max (at 200 V AC)	5 mA max (@ 50 V DC)	0.1 mA max (@ 100 V DC)
Output V _{DRM} , V _{CEO} (V)	600	600	80	80
Output di/dt (A/uS)	50	50	—	—
Output dv/dt (V/uS)	250	250	—	—
Output I _t (A ² S)	18	18	—	—
Output T _j (°C) Max.	125	125	150	150
Insulation Resistance	100 MΩ min (@500V DC)			
Dielectric Strength	1500V AC, 50/60 Hz for 1 minute			
Vibration Resistance (max.)	10...55 Hz, 1.5 mm double amplitude (10 G)			
Shock Resistance (max.)	1000 m/s ² (100 G)			
Ambient Temperature	Operating: -30...+80 °C (-22...+176 °F) with no icing or condensation Storage: -30...+100 °C (-22...+212 °F) with no icing or condensation			
Standards Compliance	UL5 08, CSA C22.2 No. 14, EN/IEC 60950, EN 50011, EN 61000-6-2, EN/IEC 60947-1, -4-3			
Certifications	cURus Recognized (File No. E96956, Guide NMFT2/NMFT8), CE Marked, VDE Certified			
Ambient Humidity	Operating: 45...85% (no condensation)			
Weight	Approx. 50 g			

♣ 60 Hz full cycle time = 16.6 ms, 50 Hz full cycle time = 20 ms

Load Current Versus Ambient Temperature Characteristics

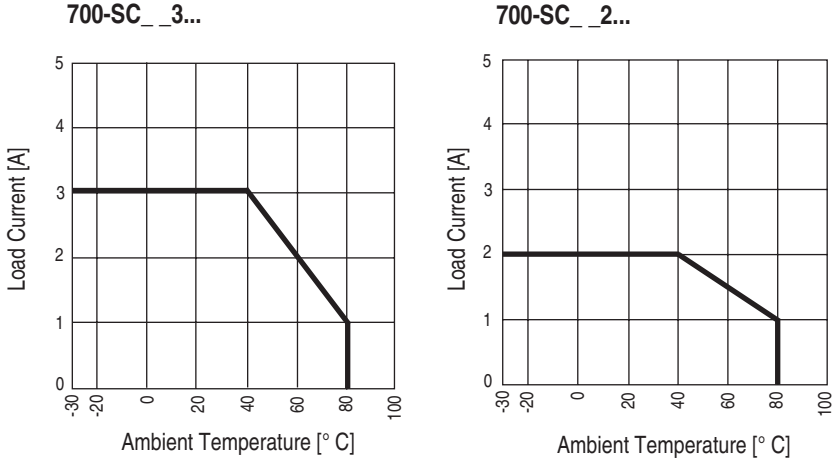

Inrush Current Resistivity*

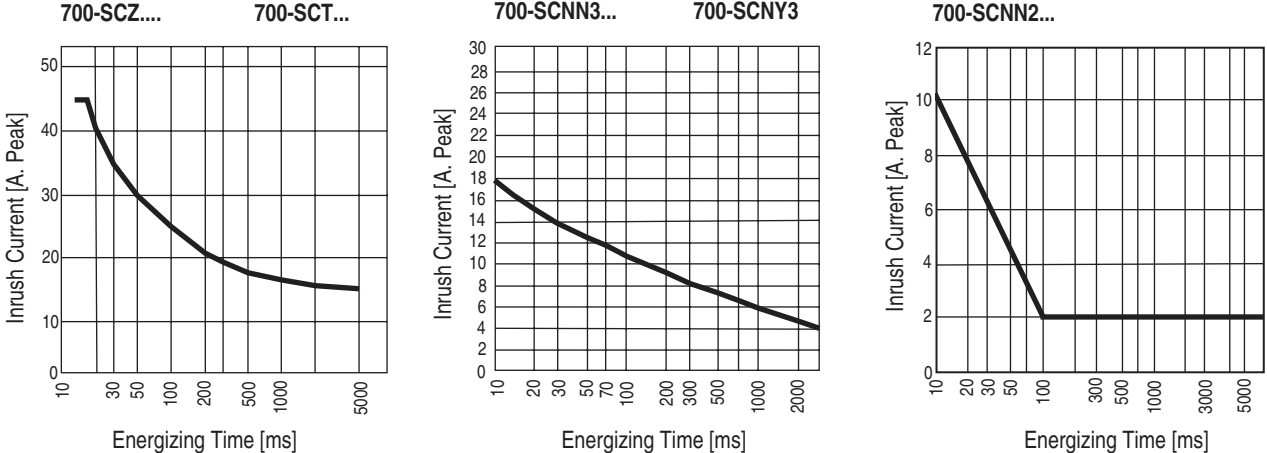

* Inrush current resistivity is the ability of an SSR to withstand a large surge current for a short period of time. Surges are considered non-repetitive (max. repeatability once every 2...5 seconds). Keep the inrush current to half the rated value if it occurs repetitively. Exceeding the non-repetitive inrush current will damage the SSR.

EMC Directive Compliance

1. AC-switching models comply with EMC Directives under the following conditions

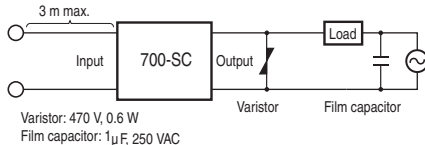

- Connect a varistor between the output terminals.
- Connect a film capacitor to the load power supply.
- The input cable must be less than 3 m.

2. DC-switching models comply with EMC Directives under the following conditions

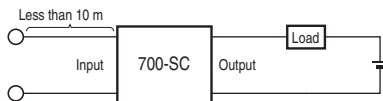

- The input cable must be less than 10 m.

Bulletin 700-SC
Solid-State Relays
 Approximate Dimensions

All units in millimeters unless otherwise indicated. To convert to inches multiply by 0.0394. Dimensions are not intended for manufacturing purposes.

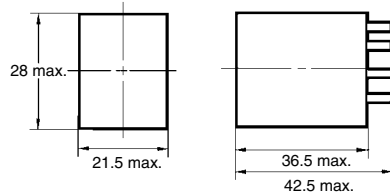
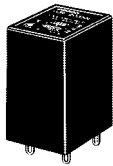

**Terminal Arrangement/
 Internal Connections
 (Bottom View)**

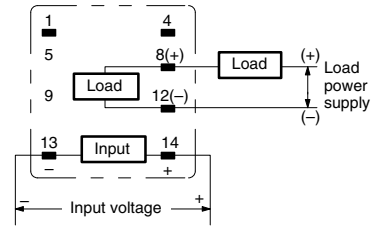

Note: The plus and minus symbols shown in parentheses are for DC loads.

Cat. No 700-SC...*

* Bulletin 700-SC is compatible with Cat. Nos. 700-HN103, -HN104, and -HN128 socket.

Basic Application Considerations For Bulletin 700-SC

Connection

For DC Load Switching, Bulletin 700-SC will operate properly if the load is connected to either the positive or negative SSR load terminal.

High-Density Mounting of Multiple SSRs

If multiple relays are mounted side-by-side, be aware that the outer wall of each SSR works as a radiator.

The SSR casing serves to dissipate heat. Install the relays so that they are adequately ventilated. If poor ventilation is unavoidable, reduce the load current by half.

Protective Component

When controlling AC inductive loads, connect an inrush/surge absorbing device (varistor) across the SSR load terminals. If the SSR has built-in surge suppression (Bulletins 700-SE and 700-SH) and additional surge suppression is required, connect the varistor across the terminals of the load device. Select a varistor that meets the conditions of the load voltage outlined in the table below.

Load Voltage [V AC]	Varistor Voltage [V]	Varistor Surge Resistance
100...120	240...270	1000 A min.
200...240	440...470	
380...480	820...1000	

For a DC inductive load, a diode should be connected parallel to the load to absorb the counter electromotive force (OFF) of the load.

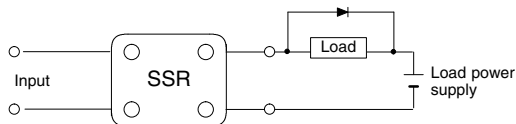



Note: For additional details when using Solid-State Relays, refer to pub. 700-AT001*, Solid-State Relay Application Guide.

	<p>Bulletin 700-SF — Square Base Relay</p> <ul style="list-style-type: none"> • 3 A (resistive) max. continuous load (output) current • 264V AC or 52.8V DC max. load voltage options • 4...24V DC control/input voltage • Photocoupler or phototriac isolation option between control and output voltage • LED Indicator for input/logic ON/OFF status monitoring • Bulletin 700-HN116 socket compatible 	<p>Table of Contents</p> <p>Product Selection this page</p> <p>Accessories..... this page</p> <p>Specifications..... 9-180</p> <p>Approximate Dimensions..... 9-182</p> <p>Standards Compliance and Certifications</p> <p>See page 9-180.</p>
---	--	---

Product Selection

	Input-to-Output Isolation Method	Zero Cross Function	Status Indicator	Output (Load) Max. Continuous Current and Rated Voltage Range	Rated Input Control Voltage	Cat. No.
	Photocoupler	Yes		3 A @ 100...240V AC (47 to 63 Hz)	5...24V DC	700-SFZY3Z25
	Phototriac	No			24V DC	700-SFTY3Z24
	Photocoupler	Not Applicable	Yes	3 A @ 4...48V DC	4...24V DC	700-SFNY3Z25

Accessories

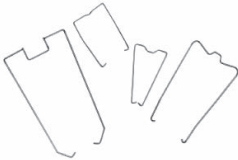
	Description	Pkg. Quantity	Cat. No.
	Screw Terminal Socket — Panel or DIN Rail Mounting 8-blade miniature socket for use with DPDT HF relays.	10	700-HN116
	DIN (#3) symmetrical hat rail 35 x 7.5 x 1 m	10	199-DR1
	Pre-Printed Identification Tags — contains 10 sheets of pre-printed and blank tags. Each sheet contains 13 sets of the markings CR...9CR, TR...9TR, M...9M, F, R, 1S, and 117 blank tags. Tags are peel-off with sticky backing for easy placement on relays.	10	700-N40
	Blank Identification Tags — contains 10 sheets of blank identification tags for customer specialized printing. Each sheet contains 546 blank tags. Tags are peel-off with sticky backing for easy placement on relays.	10	700-N41
	Retainer Clip for Cat. Nos. 700-HN103, -HN104 and -HN128 Sockets with 700-HC Relays. Secures relay in socket.	10	700-HN114*

* Bulletin 700-SF must use Cat. No. 700-HN114 series B retainer clip.

Bulletin 700-SF
Solid-State Relays
 Specifications

Specifications

Control/Input Ratings

Cat. No.	Rated Control Voltage	Max. Operating Control Voltage Range [V DC]	Max. Reverse Control Voltage [V]	Impedance	Control Voltage Levels	
					Pick-up Voltage	Drop-out Voltage
700-SFZY3Z25	5...24V DC	4...28V DC	-32	15 mA max.*	4V DC max.	1V DC min.
700-SFTY3Z24	24V DC	19.2...28.8V DC	-28.8	2 kΩ ± 20%	19.2V DC max.	1V DC min.
700-SFNY3Z25	5...24V DC	4...28V DC	-28.8	1.5 kΩ + 20%/-10%*	4V DC max.	1V DC min.

Load/Output Ratings

Cat. No.	Rated Load Voltage	Max. Load Voltage Range	Continuous Load Current (Resistive) [A]		Max. Inrush Current‡
			Min.	Max.§	
700-SFZY3Z25	100...240V AC	75...264V AC	0.1	3	45 A @ 50/60 Hz, 1 cycle
700-SFTY3Z24			0.1	3	
700-SFNY3Z25	4...48V DC	3...52.8V DC	0.1	3	18 A (10 ms)

Characteristics

Description	Cat. No. 700-SFZY3Z25	Cat. No. 700-SFTY3Z24	Cat. No. 700-SFNY3Z25
Load Switching Method/Device	Triac		Transistor
Pick-up Time	1/2 cycle of load power source cycle time ♣ + 1 ms max.	1 ms max.	0.5 ms max.
Drop-out Time	1/2 cycle of load power source cycle time ♣ + 1 ms max.		2 ms max.
Output ON Voltage Drop	1.6V (RMS) max.		1.5V max.
Output Leakage Current	5 mA max. (@ 100 V AC); 10 mA max. (@ 200 V AC)	2.5 mA max. (@ 100V AC); 5 mA max. (@ 200V AC)	5 mA max. (@ 50V DC)
Output V _{DRM} , V _{CEO} (V)	600	600	80
Output di/dt (A/uS)	50	50	—
Output dv/dt (V/uS)	250	250	—
Output I _{2t} (A ² S)	18	18	—
Output T _j (°C) Max.	125	125	150
Insulation Resistance	100 MΩ min. (at 500V DC)		
Dielectric Strength	1,500V AC, 50/60 Hz for 1 min		
Vibration Resistance (Max.)	10...55 Hz, 1.5 mm double amplitude (10 G)		
Shock Resistance (Max.)	1000 m/s ² (100 G)		
Ambient Temperature	Operating: -30...+80 °C (-22...+176 °F) with no icing or condensation Storage: -30...+100 °C (-22...+212 °F) with no icing or condensation		
Ambient Humidity	45...85% (no condensation)		
Standards Compliance	UL 508, CSA C22.2 No. 14, EN/IEC 60947-1, -4-3, EN/IEC 60950		
Certifications	cURus Recognized (File No. E96956, Guide NMFT2/NMFT8), CE Marked, VDE Certified		
Weight	Approx. 50 g		

* With constant current input circuit system, SSR impedance varies with a change in input voltage.

♣ Input impedance reaches its maximum at the operating voltage.

‡ If the SSR operation is continuous ON/OFF, this value should be reduced by 50%. Refer to the "Inrush Current Resistivity" graphs on page 9-181 for more details.

§ Refer to "Load Current vs. Ambient Temperature Characteristics" on page 9-181 for additional load current details.

♣ 60 Hz full cycle time = 16.6 ms, 50 Hz full cycle time 20 ms.



Note: This data is non-repetitive. Keep the inrush current to half the rated value if it occurs repetitively. Inrush current resistivity is the ability of an SSR to withstand a large surge current for a short period of time. Surges are considered non-repetitive (max. repeatability once every 2...5 seconds). Keep the inrush current to half the rated value if it occurs repetitively. Exceeding the non-repetitive inrush current will damage the SSR.

Load Current vs. Ambient Temperature Characteristics
 700-SF...

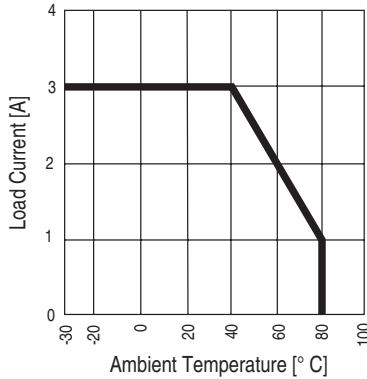

Inrush Current Resistivity*
 700-SFZ... 700SFT...

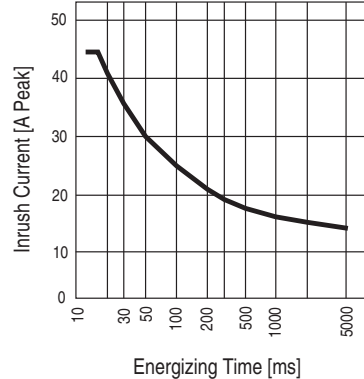

Inrush Current Resistivity*
 700-SFN...

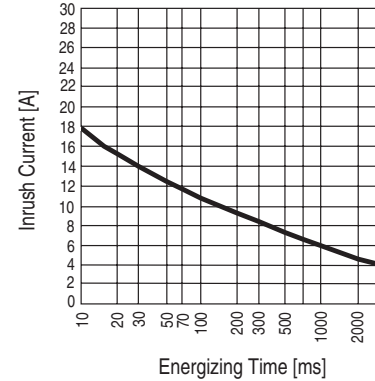

* Inrush current resistivity is defined as the ability of an SSR to withstand a large surge current for a short period of time. Surges are considered non-repetitive (max. repeatability once every 2...5 seconds). Keep the inrush current to half the rated value if it occurs repetitively. Exceeding the non-repetitive inrush current will damage the SSR.

EMC Directive Compliance

1. AC-switching models comply with EMC Directives under the following conditions

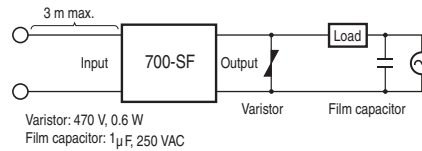

- Connect a varistor between the output terminals.
- Connect a film capacitor to the load power supply.
- The input cable must be less than 3 m.

2. DC-switching models comply with EMC Directives under the following conditions

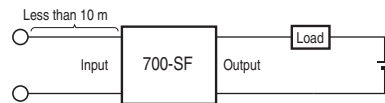

- The input cable must be less than 10 m.

Bulletin 700-SF
Solid-State Relays
 Approximate Dimensions

Approximate Dimensions

All units are in millimeters unless otherwise indicated. To convert to inches multiply by 0.0394. Dimensions are not intended for manufacturing purposes.

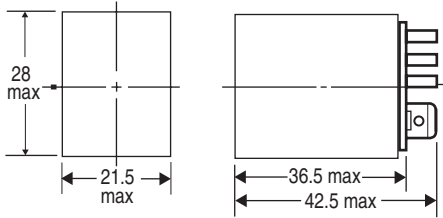

Terminal Arrangement/Input Connections
 (Bottom View)

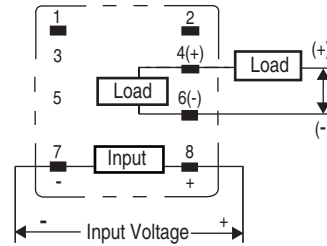

Notes: 1. The plus and minus symbols shown in parentheses are for DC loads.
 2. The coil has no polarity.

Note: Bul. 700-SF is compatible with Cat. No. 700-HN116 socket.

Basic Application Considerations of Bulletin 700-SF

High Density Mounting of Multiple SSRs

If multiple SSRs are mounted side-by-side, be aware that the outer case wall of the SSR acts as a radiator. The SSR case serves to dissipate heat. Install the relays so that they are adequately ventilated. If poor ventilation is unavoidable, reduce the load current by half.

Connection

For DC load switching, the Bul. 700-SF SSR will operate properly if the load is connected to either the positive or negative load terminals.

Protective Component To Extend SSR Life

When controlling AC inductive loads, connect an inrush/surge absorbing device (varistor) across the SSR load terminals. If the SSR has built-in surge suppression (Bulletins 700-SE and 700-SH) and additional surge suppression is required, connect the varistor across the terminals of the load device. Select a varistor that meets the conditions of the load voltage outlined in the table below.

Load Voltage [V AC]	Varistor Voltage [V]	Varistor Surge Resistance
100...120	240...270	1000 A min.
200...240	440...470	
380...480	820...1000	

For a DC inductive load, a diode should be connected parallel to the load to absorb the counter electromotive force (OFF) of the load.

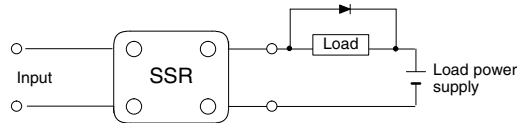

Note: For additional details when using Solid-State Relays, refer to pub. 700-AT001*, Solid-State Relay Application Guide.



Bulletin 700-SH — Hockey Puck Relay

- 100 A max. continuous load (output) current with appropriate heat sink
- 264V AC, 530V AC, or 660V AC max. load voltage options
- 3...32V DC, 4...32V DC, 80...130V AC, 200...260V AC, 20...280V AC/22...48V DC control (input) voltage options
- LED indicator for input/logic ON/OFF status monitoring
- Protective cover for added safety

Table of Contents

Product Selection this page
 Accessories..... 9-184
 Specifications..... 9-185
 Approximate
 Dimensions..... 9-188
**Standards Compliance
 and Certifications**
 See page 9-185.

Product Selection

	Input-to-Output Isolation Method	Zero Cross Function	Status Indicator	Output (Load) Max. Continuous Current and Rated Voltage Range†	Rated Input Control Voltage	Cat. No.*
	Optocoupler	Yes	Yes	10 A @ 42...265V AC	3...32V DC	700-SH10JZ24
				10 A @ 42...265V AC	80...130V AC	700-SH10JA12
				10 A @ 42...265V AC	200...260V AC	700-SH10JA22
				10 A @ 42...530V AC	4...32V DC	700-SH10HZ25 (Series B)
				25 A @ 42...530V AC	4...32V DC	700-SH25HZ25 (Series B)
				25 A @ 24...265V AC	3...32V DC	700-SH25GZ24
				25 A @ 24...265V AC	20...280V AC/22...48V DC	700-SH25GA24
				50 A @ 24...265V AC	3...32V DC	700-SH50GZ24
				50 A @ 24...265V AC	20...280V AC/22...48V DC	700-SH50GA24
				50 A @ 42...530V AC	4...32V DC	700-SH50HZ25
				25 A @ 42...660V AC	4...32V DC	700-SH25VZ25
				25 A @ 42...660V AC	20...280V AC/22...48V DC	700-SH25VA24
				50 A @ 42...660V AC	4...32V DC	700-SH50VZ25
				50 A @ 42...660V AC	20...280V AC/22...48V DC	700-SH50VA24
				75 A @ 42...530V AC	4...32V DC	700-SH75HZ25
				75 A @ 42...660V AC	4...32V DC	700-SH75VZ25
				75 A @ 42...530V AC	20...280V AC/22...48V DC	700-SH75HA24
				75 A @ 42...660V AC	20...280V AC/22...48V DC	700-SH75VA24
				100 A @ 42...530V AC	4...32V DC	700-SH100HZ25
				100 A @ 42...530V AC	20...280V AC/22...48V DC	700-SH100HA24
				100 A @ 42...660V AC	4...32V DC	700-SH100VZ25
100 A @ 42...660V AC	20...280V AC/22...48V DC	700-SH100VA24				
	Yes	No	5A @ 3...60V DC	3...32V DC	700-SH5FZ24	
	Yes	Yes	25 A @ 90...280V AC	4...20 mA DC	700-SH25WA25	
			50 A @ 90...280V AC	4...20 mA DC	700-SH50WA25	

* All catalog numbers are Series A unless noted.
 * This type is also called Phase Angle 0.
 † When used with heat sink.

Bulletin 700-SH
Solid-State Relays
 Accessories

	Description	Pkg. Quantity	Cat. No.
	Heat Sink— Panel or DIN Rail Mount	1	700-SN10
	Heat Sink— Panel or DIN Rail Mount	1	700-SN25
	Heat Sink— Panel or DIN Rail Mount	1	700-SN50
	Heat Sink— Panel or DIN Rail Mount	1	700-SN50HC
	Heat Sink— Panel or DIN Rail Mount	1	700-SN50VHC
	DIN (#3) symmetrical hat rail 35 x 7.5 x 1 m	10	199-DR1
	Thermal Conductive Pads	50	700-SHCPAD
	Plastic Covers — for DC output version	25	700-SHCOV
	Thermal Adapters - for 100 A Wire	10	700-SHTRMA

Control/Input Ratings

Cat. No.	Operating Voltage	Input Current @ Max. Voltage	Voltage Level Pickup Voltage	Drop-Out Voltage
700-SH10J...	3...32V DC	12 mA	2.75V DC max.	1.2V DC min.
	80...130V AC	13 mA	70V AC max.	30V AC min.*
	200...280V AC	13 mA	190V AC max.	90V AC min.
700-SH_ _ H...	4...32V DC	12 mA	4V DC max.	1V DC min.
	20...280V AC/22...48V DC	20 mA	18V AC/DC	6V AC/DC
700-SH_ _ G...	3...32V DC	12 mA	2.5V DC	1.2V DC
	20...280V AC/22...48V DC	20 mA	-32V DC	6V AC/DC
700-SH_ _ V...	4...32V DC	12 mA	3.5V DC	1.2V DC
	20...280V AC/22...48V DC	20 mA	18V AC/DC	6V AC/DC
700-SH_ _ W...	Current Control	4...20 mA	—	—
700-SH_ _ F...	3...32V DC	12 mA	3V DC max.	1.0V DC

* When specified heatsink is used.

Output Ratings

Cat. No.	Load Voltage Range	Applicable Load Current with Heat Sink [A]*
700-SH5FZ24	3...60V DC	0.001...5 A DC
700-SH10J...	42...265V AC	0.15...10
700-SH10H...	42...530V AC	0.15...10
700-SH25G...	24...265V AC	0.15...25
700-SH25H...	42...530V AC	0.15...25
700-SH25V...	42...660V AC	0.15...25
700-SH25W...	90...280V AC	0.15...25
700-SH50G...	24...265V AC	0.15...50
700-SH50H...	42...530V AC	0.15...50
700-SH50V...	42...660V AC	0.15...50
700-SH50W...	90...280V AC	0.15...50
700-SH75H...	42...530V AC	0.15...75
700-SH75V...	42...660V AC	0.15...75
700-SH100H...	42...530V AC	0.15...100
700-SH100V...	42...660V AC	0.15...100

* AC unless indicated.

Characteristics

Description	Cat. Nos. 700-SH10, 25, 50 (not including 700-SH_ _W)	Cat. Nos. 700-SH75, 100
Pick-up Time	1/2 of load power source cycle time(DC input) 1 of load power source cycle time (AC input)	
Drop-out Time	1/2 of load power source cycle time (DC input) 2 of load power source cycle time (AC input)	
Output ON Voltage Drop	1.6V (RMS) max.	
Output Leakage Current	<3 mArms 100 MΩ min (@ 500V DC)	
Insulation Resistance	100 MΩ min. (at 500V DC)	
Dielectric Strength	>4000 VACrms	
Vibration Resistance	Malfunction: 10...55 Hz, 1.5 mm double amplitude	
Shock Resistance	Malfunction: 1000 m/s ²	
Ambient Temperature	Operating: -20...+70 °C with no icing or condensation Storage: -40...+100 °C with no icing or condensation	
Ambient Humidity	0...95% no condensing	
Standards Compliance	UL 508, CSA C22.2 No. 14, EN/IEC 60947-1, -4-2, -4-3, EN 61000-6-2, EN 61000-6-4	
Certifications	cURus Recognized (File No. E14843, Guide NPNT2), CSA Certified (File No. 240924)	
Weight	Approx. 60 g	Approx. 100 g

Characteristics

Description	Cat. No. 700-SH_W
Pick-up Current	4.2 mA
Drop-out Current	4.1 mA
Voltage Drop	<10V DC @ 20 mA
Leakage Current	<3 mA
Insulation Voltage	<4000 Vrms
Vibration Resistance	Malfunction: 10...55 Hz, 1.5 mm double amplitude
Shock Resistance	Malfunction: 1000 m/s ²
Ambient Temperature	Operating: -20...+70 °C with no icing or condensation
Ambient Humidity	0...95% no condensing
Standards Compliance	UL 508, CSA C22.2 No. 14, EN/IEC 60947-1, -4-2, -4-3, EN 61000-6-2, EN 61000-6-4
Certifications	cURus Recognized (File No. E14843, Guide NPNT2), CSA Certified (File No. 24024)
Weight	Approx. 60 g

Description	Cat. No. 700-SH5FZ24
Pick-up Voltage	<3V DC
Drop-out Voltage	>1V DC
Activating Frequency	<100 Hz
Input Impedance	1kΩ
Response Time Pick-up @ Vin > 5V	<4000 μS
Response Time Drop-out	<1 mS
On-state Voltage Drop @ Rated Current	<1.5V
Off-state Current Drop @ Rated Voltage	<1 mA
Insulation Voltage	<1 mA
Vibration Resistance	Malfunction: 10...55 Hz, 1.5 mm double amplitude
Shock Resistance	Malfunction: 1,000 m/s ²
Ambient Temperature	Operating: -20...+70 °C with no icing or condensation
Ambient Humidity	0...95% no condensing
Standards Compliance	UL 508, CSA C22.2 No. 14, EN/IEC 60947-1, -4-2, -4-3, EN 61000-6-2, EN61000-6-4
Certifications	cURus Recognized (File No. E14843, Guide NPNT2), CSA Certified (File No. 240924)
Weight	Approx. 60 g

Surge Current vs. Ambient Temperature Characteristics

9

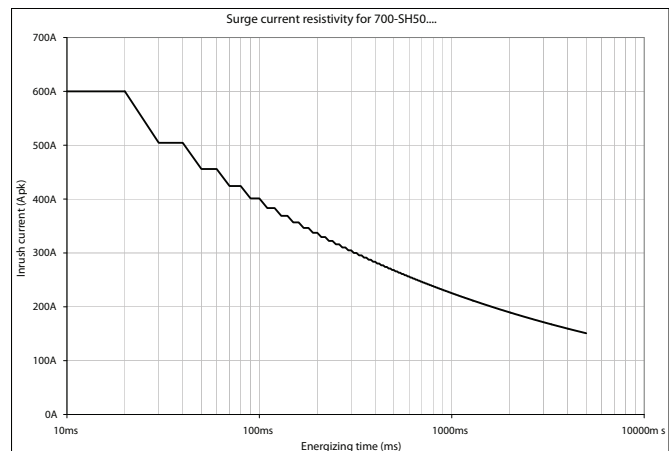
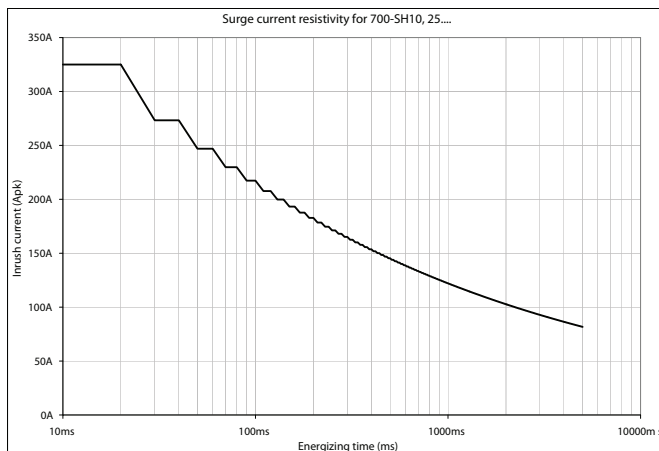

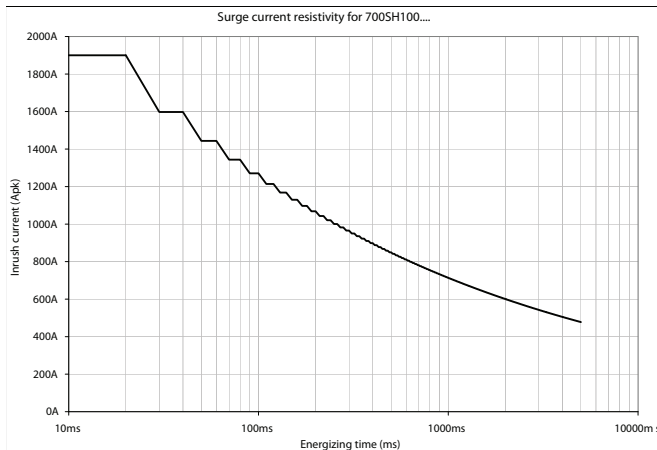
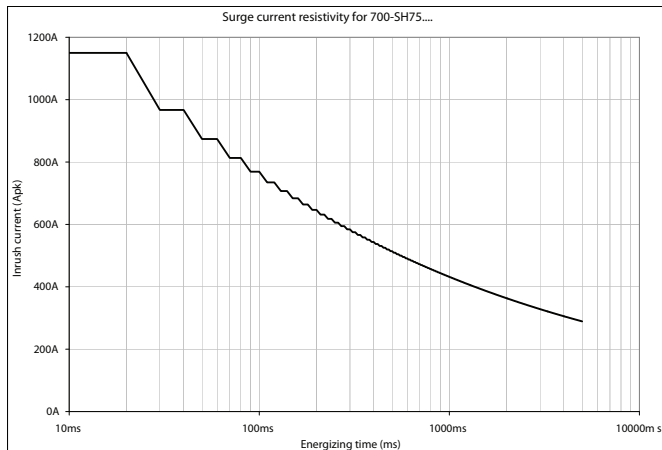

Load Current vs. Ambient Temperature Characteristics

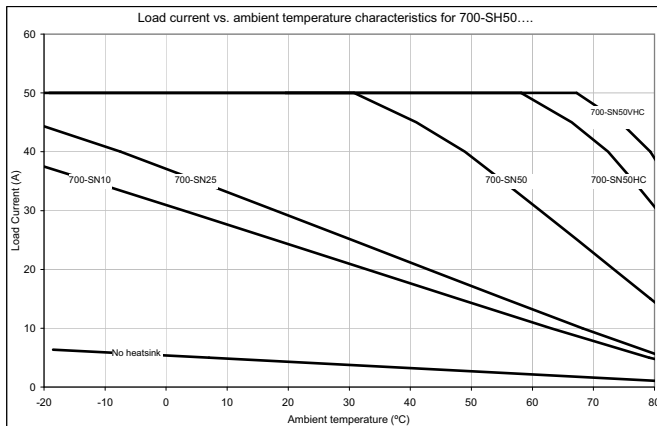
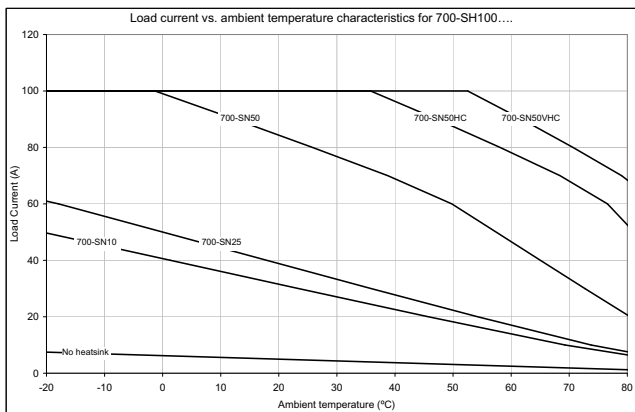
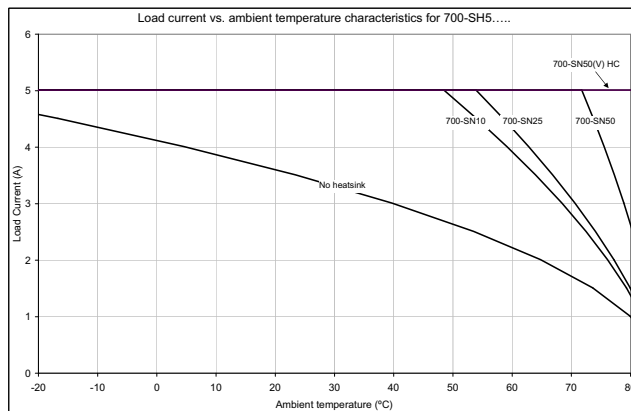
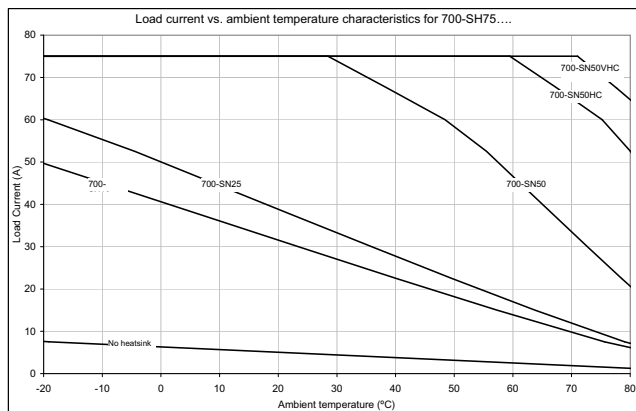
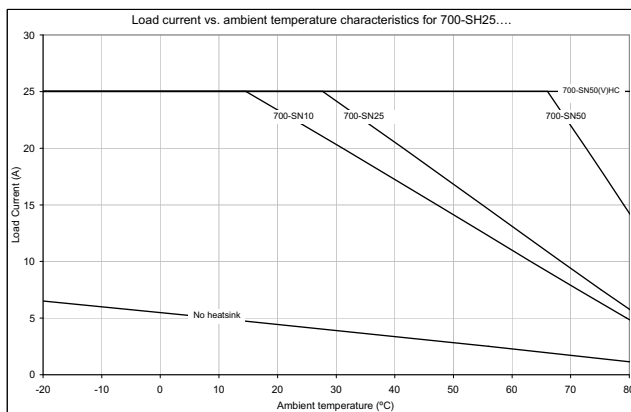
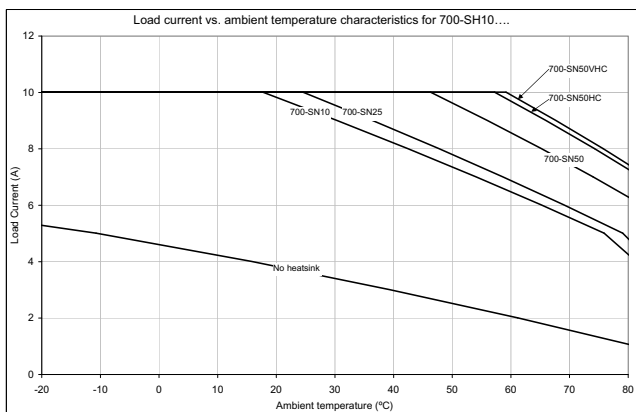

Bulletin 700-SH
Solid-State Relays
 Approximate Dimensions

Mounting Considerations * ‡ † ‡

All units are in mm's unless otherwise indicated. To convert to inches multiply by 0.0394. Dimensions are not intended for manufacturing purposes.

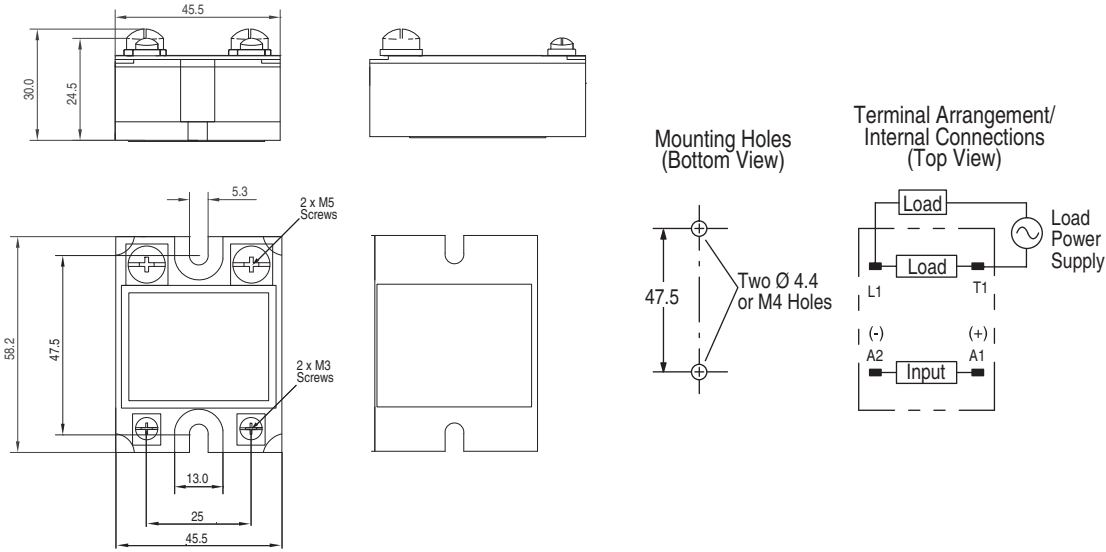

Cat. No. 700-SH5F...

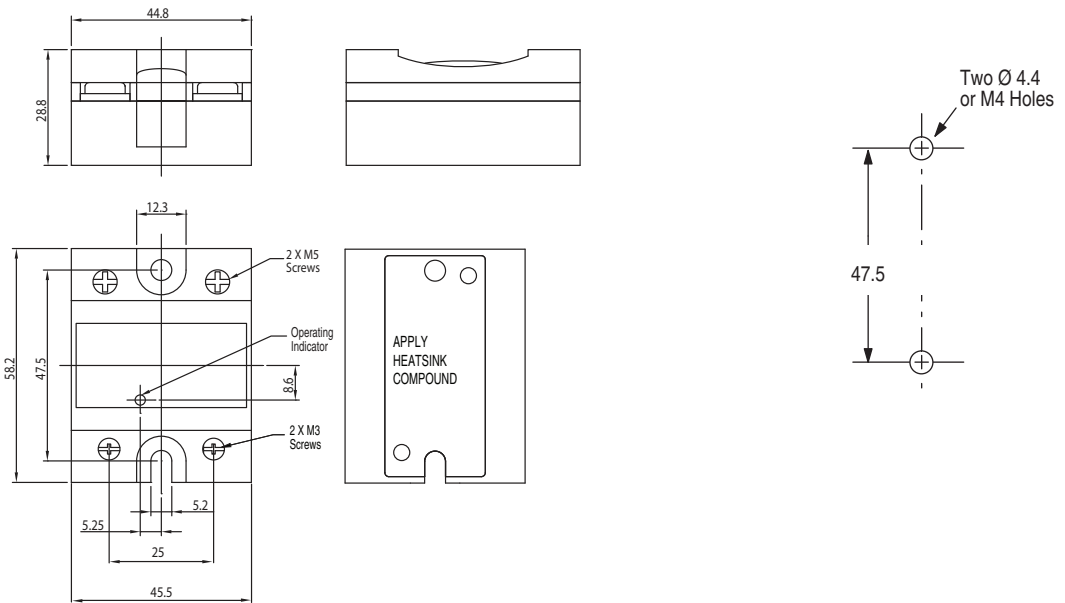

Cat. No. 700-SH10, -SH25, -SH50, -SH75, -SH100

- * The proper mounting orientation of the heat sink is so the heat fins run perpendicular to the floor (vertical) to maximize ventilation flow. If the fins do not run perpendicular to the floor, a 30% current derating is required.
- ‡ When attaching a heat sink to Bulletin 700-SH, apply a thin layer of heat conductive grease (approximately 0.002 in. thick) on the heat sink to maximize heat transfer between the SSR and the heat sink. Recommended types: Silicon based, Dow Corning 340, Toshiba YG6240; Non-silicon based, AOS company type 53300 (Cat. No. 46801-010-01).
- † Tighten the SSR panel/heat sink mounting screws to a torque of 0.78...0.98 N•m (6.9...8.7 lb•in).
- ‡ Tighten the SSR terminal wiring screws as follows M4: 0.98...1.37 N•m (8.67...12.12 lb•in), M5: 1.57...2.35 N•m (13.89...20.8 lb•in).

700-SN10

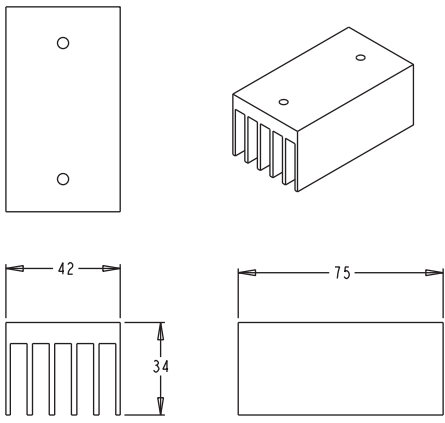

700-SN25

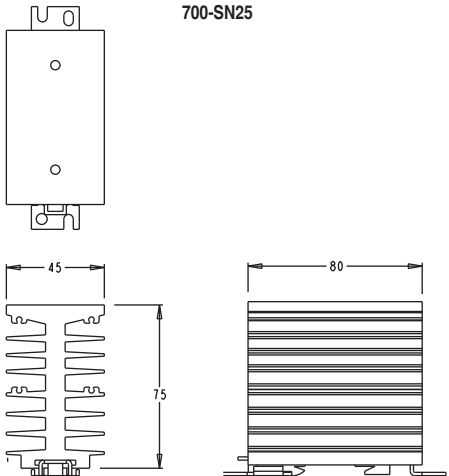

700-SN50

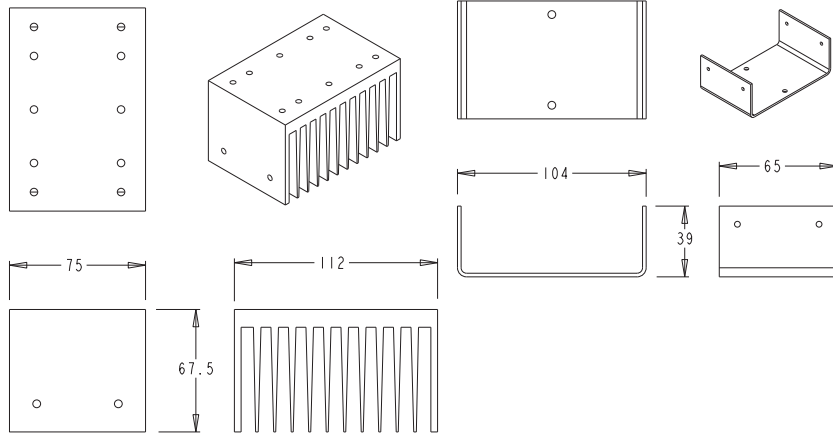

700-SN50HC

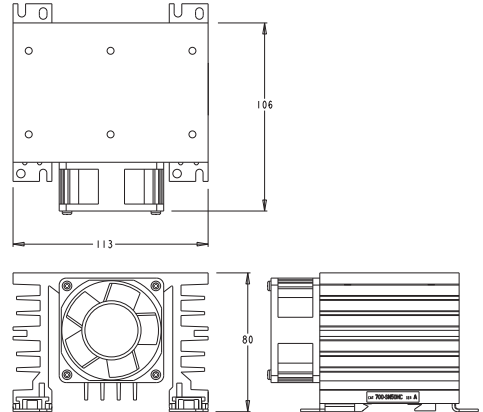

700-SN50VHC

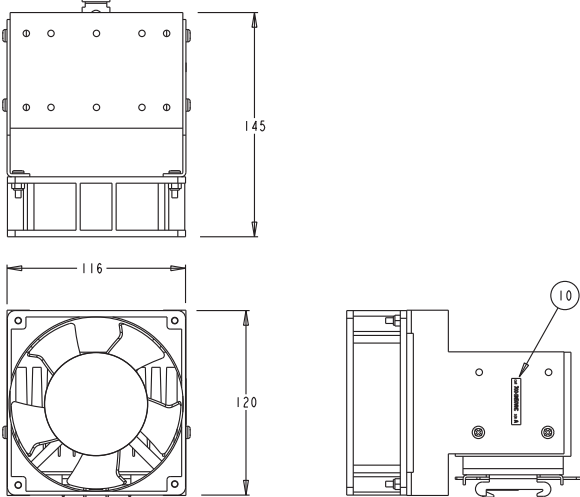

► Tighten the heat sink mounting screws (M4) to a torque of 0.98...1.37 N•m (8.67...12.12 lb•in).
 ⚙️ Heat sink weight: Cat. Nos. 700-S10 = 200 g, 700-S20 = 400 g, 700-S30 = 560 g.

Bulletin 700-SH
Solid-State Relays

Approximate Dimensions/ Basic Applications Considerations

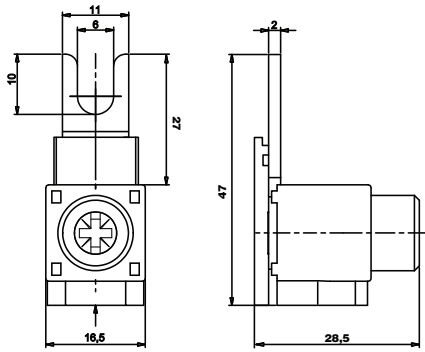

Cat. No. 700-SHTRMA

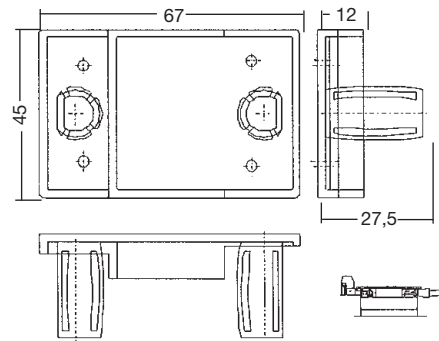

Cat. No. 700-SHCOV

Load Connection

- For an AC load, use a power supply rated at 50 or 60 Hz. The maximum operating frequency is 10 Hz.
- The Bulletin 700-SH has a built-in varistor for surge/inrush protection of AC loads. If additional suppression is required, connect an external varistor across the load device terminals. Select a varistor which meets the load voltage condition outlined in the table below.

Load Voltage [V AC]	Varistor Voltage [V]	Varistor Surge Resistance
100...120	240...270	1000 A min.
200...240	440...470	
380...480	820...1000	

Zero Cross Function

A SSR with a zero cross function operates when an AC load voltage reaches the zero point or its vicinity. This reduces clicking noises when the load is switched and minimizes the influence of an inductive load, (e.g., lamp, heater, or motor) on the power supply because the inrush current of the load is reduced. This can also minimize the scale of the inrush current protection circuit.

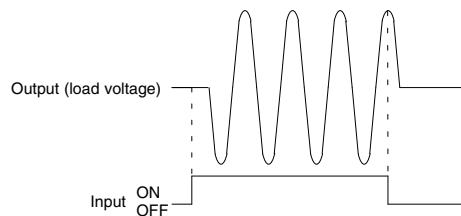

At a low applied voltage (e.g., 24V AC) the load current is not fully supplied. When the unit is switched ON, the voltage required to power the unit deprives the output signal of the necessary voltage level and thus creates loss time. The lower the load voltage is, the greater the loss time is. This condition, however, will not create any serious problems.

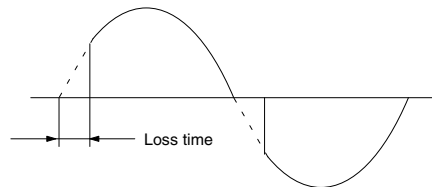

For a DC inductive load, a diode should be connected parallel to the load to absorb the counter electromotive force (OFF) of the load.

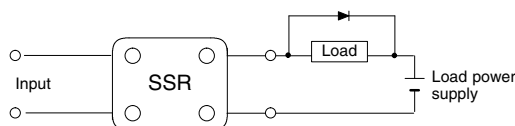

Note: For additional details when using Solid-State Relays, refer to pub. 700-AT001*, Solid-State Relay Application Guide.

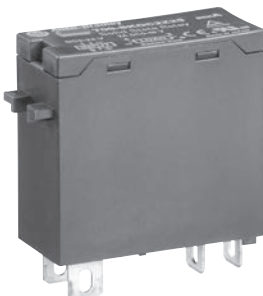
	<p>Bulletin 700-SK — Slim Line Relay</p> <ul style="list-style-type: none"> • High-response speed models • Input sensor module to slow high voltage 100...240V AC or 12...24V DC sensor • Interface to low voltage (logic) device such as a PC output module for typical SSR applications • LED indicator • Input modules and output modules can be used with the Bulletin 700-HN121 or 700-HN221 sockets 	<p>Table of Contents</p> <p>Product Selection this page</p> <p>Accessories..... this page</p> <p>Specifications..... 9-192</p> <p>Approximate Dimensions..... 9-194</p> <p>Standards Compliance and Certifications</p> <p>See page 9-193.</p>
---	---	---

Product Selection

Input/Sensor Module



Input-to-Output Isolation Method	Status Indicator	Response Frequency	Logic Level		Rated Input Sensor Voltage	Cat. No.
			Supply Voltage	Supply Current		
Photocoupler	Yes	10 Hz	4...32V DC	0.1...100 mA	100...240V AC*	700-SKICA18
		1 kHz			12...24V DC	700-SKICZ24

Output/SSR Module

Input-to-Output Isolation Method	Zero Cross Function	Status Indicator	Output (Load) Max. Continuous Current and Rated Voltage Range	Rated Input Control Voltage	Cat. No.
Phototriac	Yes	Yes	2 A @ 100...240V AC*	5...24V DC	700-SKOZ2Z25
	No		700-SKON2Z25		
Photocoupler	Not Applicable		2 A @ 5...48V DC		700-SKOC2Z25
			1.5 A @ 48...200V DC		700-SKOC1Z25

* 47...63 Hz

Accessories

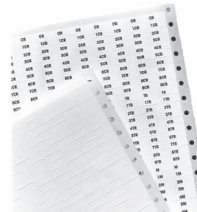
	Description	Pcs./Pkg.	Cat. No.
	Screw Terminal Socket — Panel or DIN Rail Mounting 5-blade miniature socket with 10 A rating for use with 1-pole, Bulletin 700-HK relays. Accepts forked lug conductors. Socket includes a retainer clip.	10	700-HN121
	Screw Terminal Socket — Panel or DIN Rail Mounting 5-blade miniature socket with 16 A rating for use with 1-pole, Bulletin 700-HK relays. Retainer clips are packaged separately with socket. Guarded terminal construction and compatible with optional plug-in module accessories.	10	700-HN221
	DIN (#3) symmetrical hat rail 35 x 7.5 x 1 m	10	199-DR1
	Pre-Printed Identification Tags — contains 10 sheets of pre-printed and blank tags. Each sheet contains 13 sets of the markings CR...9CR, TR...9TR, M...9M, F, R, 1S, and 117 blank tags. Tags are peel-off with sticky backing for easy placement on relays.	10	700-N40
	Blank Identification Tags — contains 10 sheets of blank identification tags for customer specialized printing. Each sheet contains 546 blank tags. Tags are peel-off with sticky backing for easy placement on relays.	10	700-N41

Bulletin 700-SK
Solid-State Relays
 Specifications

Input Sensor Module

Input Sensor Ratings

Cat. No.	Rated Input Voltage	Max. Operating Input Voltage Range	Input Current	Pick-up Voltage	Drop-out Voltage
700-SKICZ24	12...24V DC	6.6...32V DC	8 mA max.	6.6V DC max.	3.6V DC min.
700-SKICA18	100...240V AC	60...264V AC	15 mA max.	60V AC max.	20V AC min.

Output Logic Ratings

Cat. No.	Logic Level Supply Voltage	Logic Level Supply Current Draw
700-SKICZ24	4...32V DC	0.1...100 mA
700-SKICA18		

Characteristics

Description	Cat. No. 700-SKICA18	Cat. No. 700-SKICZ24
Pick-up time	20 ms max.	0.1 ms max.
Drop-out time	20 ms max.	0.1 ms max.
Response frequency	10 Hz	1 kHz
Output ON voltage drop	1.6V max.	
Leakage current	5 μ A max.	
Output V_{DRM} , V_{CEO} (V)	80 (ref. value)	80 (ref. value)
Output di/dt (A/ μ S)	—	—
Output dv/dt (V/ μ S)	—	—
Output I^2t (A ² S)	—	—
Output Tj (°C) Max.	150	150
Insulation Resistance	100 M Ω min. between input and output	
Dielectric Strength	4000V AC, 50/60 Hz for 1 min between input and output	
Vibration Resistance (Max.)	10...55 Hz, 1.5 mm double amplitude (10 G)	
Shock Resistance (Max.)	1000 m/s ² (100 G)	
Ambient Temperature	Operating	-30...+80 °C (-22...+176 °F) with no icing or condensation
	Storage	-30...+100 °C (-22...+212 °F) with no icing or condensation
Standards Compliance	UL 508, CSA C22.2 No. 14, EN/IEC 60950	
Certifications	cURus Recognized (File No. E96956, Guide NMFT2/NMFT8), CE Marked, TÜV Certified	
Ambient humidity Operating	45...85% (no condensation)	
Weight	Approx. 18 g	

Output SSR Module

Control/Input Ratings

Cat. No.	Rated Control Voltage	Max. Operating Control Voltage Range	Max. Reverse Control Voltage	Impedance*	Pick-up Voltage	Drop-out Voltage
700-SKOZ2Z25	5...24V DC	4...32V DC	-32V DC	15 mA max. at 25 °C (77 °F)	4V DC max.	1V DC min.
700-SKON2Z25						
700-SKOC2Z25						
700-SKOC1Z25				8 mA max.		

Load/Output Ratings

Cat. No.	Rated Load Voltage	Maximum Load Voltage Range	Continuous Load Current (Resistive) [A]		Max. Inrush Current*
			Min.	Max.†	
700-SKOZ2Z25	100...240V AC	75...264V AC	0.05	2	30 A (@50/60 Hz, 1 cycle)
700-SKON2Z25					
700-SKOC2Z25	5...48V DC	4...60V DC	0.1	2	8 A (10 ms)
700-SKOC1Z25	48...200V DC	40...200V DC	0.1	1.5	8 A (10 ms)

* With a constant current input system. SSR impedance varies with a change in input voltage.

† If the SSR operation is continuous ON/OFF, this value should be reduced by 50%. Refer to the "Inrush Current Resistivity" graphs on page 9-193 for more details.

‡ Refer to "Load Current vs. Ambient Temperature Characteristics" graphs on page 9-193 for additional details.

Output Module, Continued

Characteristics

Description	Cat. No. 700-SKOZ2Z25	Cat. No. 700-SKON2Z25	Cat. No. 700-SKOC2Z25	Cat. No. 700-SKOC1Z25
Load Switching Method/Device	Triac			Transistor
Pick-up Time	1/2 cycle of load power source cycle time* + 1 ms max.			1 ms max.
Drop-out Time	1/2 of load power source cycle time* + 1 ms max.			2 ms max.
Response Frequency	20 Hz			100 kHz
Output ON Voltage Drop	1.6V max.			2.5V max.
Leakage Current	1.5 mA max.			1 mA max.
Output V _{DRM} , V _{CEO} (V)	600 (ref.value)	600 (ref.value)	80 (ref.value)	400 (ref.value)
Output di/dt (A/uS)	30	30	—	—
Output dv/dt (V/uS)	300	300	—	—
Output I ² t (A ² S)	10.4	10.4	—	—
Output T _j (°C) Max.	125	125	150	150
Insulation Resistance	100 MΩ min. between input and output			
Dielectric Strength	4000V AC, 50/60 Hz for 1 min between input and output			
Vibration Resistance (Max.)	10...55 Hz, 1.5 mm double amplitude (10 G)			
Shock Resistance (Max.)	1000 m/s ² (100 G)			
Ambient Temperature	Operating	-30...+80 °C (-22...+176 °F) with no icing or condensation		
	Storage	-30...+100 °C (-22...+212 °F) with no icing or condensation		
Standards Compliance	UL 508, CSA C22.2 No. 14, EN/IEC 60950			
Certifications	cURus Recognized (File No. E96956, Guide NMFT2/NMFT8), CE Marked, TÜV Certified			
Ambient Humidity	Operating	45...85% (no condensation)		
Weight	Approx. 18 g			

* 60 Hz cycle time = 16.6 ms, 50 Hz cycle time = 20 ms.

Load Current vs. Ambient Temperature Characteristics

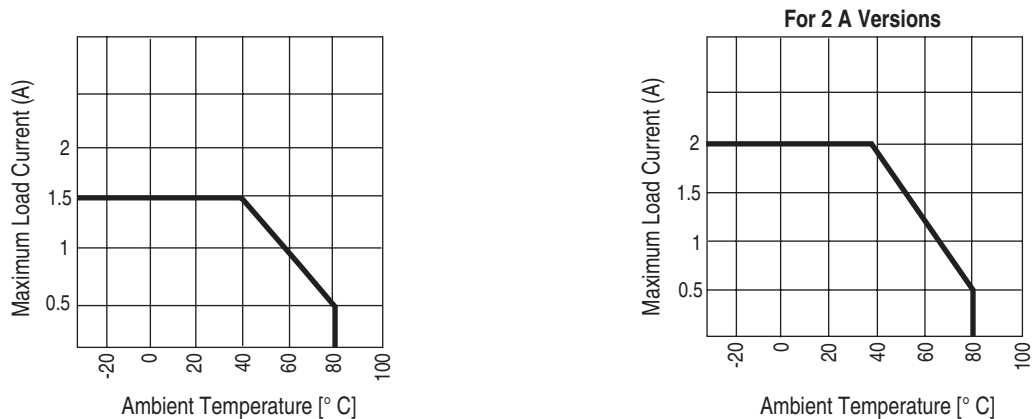

Inrush Current Resistivity*

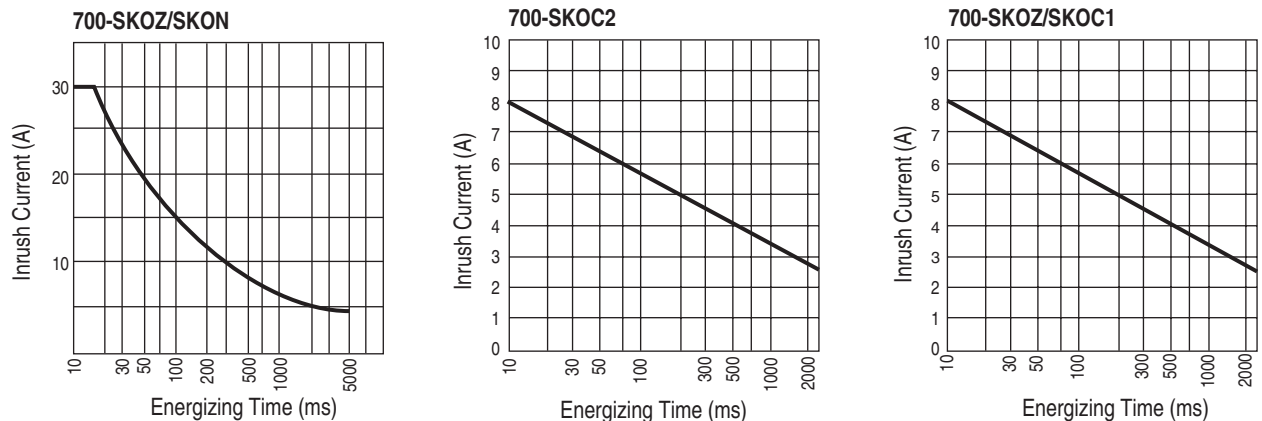

* Inrush current resistivity is the ability of an SSR to withstand a large surge current for a short period of time. Surges are considered non-repetitive (max. repeatability once every 2...5 seconds). Keep the inrush current to half the rated value if it occurs repetitively. Exceeding the non-repetitive inrush current will damage the SSR.

Bulletin 700-SK
Solid-State Relays
Approximate Dimensions

All units are in millimeters unless otherwise indicated. To convert to inches multiply by 0.0394. Dimensions are not to be used for manufacturing purposes.

Note: The input module (Bul. 700-SKI) and output module (Bul. 700-SKO) are compatible with the Cat. No. 700-HN121 socket.

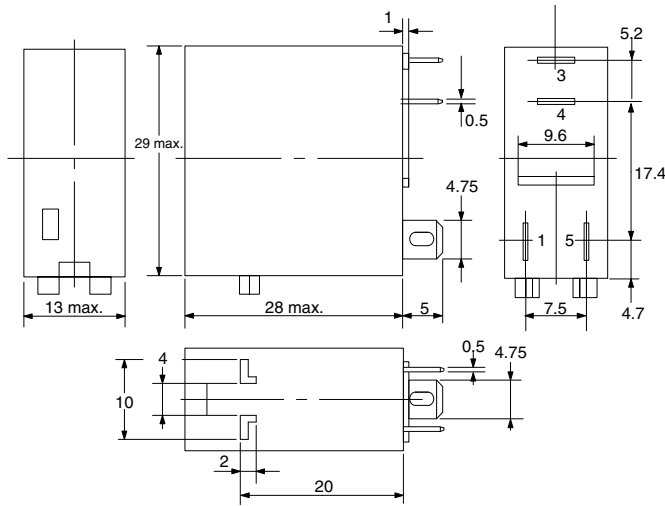

**Terminal Arrangement/
 Internal Connections
 (Bottom View)**

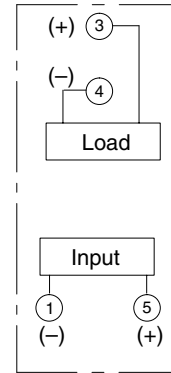

Application Considerations of Bulletin 700-SK

Connection

For DC load switching, Bulletin 700-SK SSR will operate properly if the load is connected to either the positive or negative SSR load terminal. The load can be connected to either positive or negative output terminals of the SSR.

Protective Element (to extend SSR life)

Since the SSR does not incorporate a surge absorption component, be sure to connect a surge absorption component when using the SSR to control an inductive load.

For additional details applying solid-state relays, refer to pub. 700-AT001A*, Solid-State Relay Application Guide.



**Bulletin
900-TC32**



**Bulletin
900-TC16**



**Bulletin
900-TC8**

Bulletin 900-TC — Temperature/Process Controllers

- Single-loop, high value, ON/OFF, or analog output controllers
- 1/8 DIN (Bulletin 900-TC8), 1/16 DIN (Bulletin 900-TC16), and 1/32 DIN (Bulletin 900-TC32) sizes
- Various sensor inputs
 - Thermocouple and 0...50 mV
 - Platinum RTD
 - Non-contact temperature sensor
 - Analog input **4...20 mA, 0...20 mA, 1...5, 0...5 or 0...10V DC** and 0...50 mV (TC8 & TC16)
- Auto-tuning and self-tuning available to simplify startup
- Heating, cooling, or heating/cooling control available
- **Manual output control (TC8 and TC16)**
- High visibility 4-digit, 11-segment LED displays, easy to see in high levels of ambient light
- Integral keypad with tactile feedback for setup and modification of parameters
- Security modes/levels
- Event input (TC8 and TC16) for multiple SP selection, controller RUN/STOP and auto/manual mode change
- Water-resistant construction, IP66 for indoor use
- On-board wiring diagrams to simplify startup

Table of Contents

Product Selection 9-196
 Specifications § 9-199
 Approximate Dimensions..... 9-205

Standards Compliance

UL 61010-1
 CSA C22.2, No. 1010.1

Certifications

cULus Listed (File No. E 197887, Guide No. QUXX, QUXX7)
 CE Marked

Item	Bulletin No.		
	900-TC8	900-TC16	900-TC32
Dimensions	48 x 96 x 78 mm	48 x 48 x 78 mm	48 x 24 x 99 mm
Sample Rate	250 ms		
Indication Accuracy	Thermocouple: ±0.3% of PV; RTD: ±0.2% of PV; Analog: ±0.2% of F.S.		
Heating/Cooling Control Mode	Yes	Yes	Yes
Control Method	ON/OFF or 2-PID (auto-tune and self-tune) with time proportioning ON/OFF outputs or Analog Output		
Inputs	Thermocouple Input and 0...50 mV	Yes	Yes
	Platinum Resistance Temperature Sensor	Yes	Yes
	Analog Input 0...20 mA, 4...20 mA, 1...5V DC, 0...5V DC, 0...10V DC	—	—
	Non-Contact Temperature Sensor	Yes	Yes
Control Output 1 Type	ON/OFF Relay Output (Electro-Mechanical)	Yes	Yes
	ON/OFF Voltage Output for Solid-State Relay	Yes	Yes
	ON/OFF Triac (AC Only)	Yes	Yes
	4...20 and 0...20 mA (DC) Analog	Yes	Yes
Control Output 2 Types	ON/OFF Relay	No ☹	No ☹
	ON/OFF Triac	Yes >	No
	ON/OFF Voltage SSR	Yes >	Yes ‡
Maximum Number of Alarms	None	—	—☹
	1 Point	—	—
	2 Points	—	—
	3 Points	Yes	Yes
RS-232C Communications Function	Yes §	No	No
RS-485 Communications Function	Yes §	Yes §	Yes >
Event Input	Yes §	Yes §	No
Run/Stop via Keypad or Interrupts	Yes	Yes	Keypad
Multiple SP Selection via Keypad or Interrupts	Yes ♣	Yes ♣	Keypad
Manual Output Control via Keypad or Interrupts	Yes ♣	Yes ♣	No
Transfer Output Function (Requires Analog Output)	Yes	Yes	No
Heater Burnout and Heater Short Alarm (1- or 3-Phase)	Yes †	Yes †	No
Product Selection	Page 9-196	Page 9-197	Page 9-197

☹ When RS-485 communication is required.

‡ Requires an option unit with an SSR output. Refer to Option Unit table on page 9-198

§ Requires an option unit. Refer to Option Unit table on page 9-198.

♣ Interrupts require an event input option unit. Refer to Option Unit table on page 9-198

> Determined by controller catalog number.

☹ One of the controller alarm relays can be used as a second control output (e.g., a heating and cooling application).

† Requires addition of hardware. One current transformer (900-CT1 or 900-CT2) for single-phase and two current transformers for 3-phase detection. For the 900-TC16, the appropriate option unit must be purchased. Refer to Option Units on page 9-198.

Bulletin 900-TC
Digital Temperature Controller
 Product Selection

Bulletin 900-TC8 Controller Models

Bulletin No.	DIN Size	Sensor Input Type	Power Supply Voltage	Max No. of Auxiliary Outputs Supported >	Control Output 1 Type	Control Output 2 Type	Supports Heater Burnout (Open) and Heater Short-Circuit Alarm	Controller Cat. No.
900-TC8 *⊛	1/8 DIN 48 mm (W) x 96 mm (H) x 78 mm (D)	Thermocouple or RTD	100... 240V AC	3	Relay	—	No	900-TC8RGTZ25
						—	Yes (1-Phase)	900-TC8RGTH1Z25
						Voltage (for driving SSR)	No	900-TC8RVGTZ25
						—	Yes (3-Phase)	900-TC8RGTH3Z25
					Voltage (for driving SSR)	—	No	900-TC8VGTZ25
						—	Yes (1-Phase)	900-TC8VGTH1Z25
						TRIAC ⊛	No	900-TC8VYGTZ25
						Voltage (for driving SSR)	No	900-TC8VVGZ25
						—	Yes (3-Phase)	900-TC8VGTH3Z25
						—	No	900-TC8ACGTZ25
						TRIAC ⊛	No	900-TC8ACYGTZ25
					0...20 or 4...20 mA Analog Output	Voltage (for driving SSR)	No	900-TC8ACVGTZ25
						—	No	900-TC8RGTU25
						—	Yes (1-Phase)	900-TC8RGTH1U25
					Thermocouple or RTD	24V AC/DC	3	Relay
	—	Yes (1-Phase)	900-TC8RGTH1U25					
	Voltage (for driving SSR)	—	No	900-TC8VGTU25				
		—	Yes (1-Phase)	900-TC8VGTH1U25				
	Analog Current & Voltage 0...20 and 4...20 mA 0...5, 1...5, and 0...10V DC	100... 240V AC	3	Relay	—	Yes (1-Phase)	900-TC8RABH1Z25	
					—	No	900-TC8RABZ25	
				Voltage (for driving SSR)	—	Yes (1-Phase)	900-TC8VABH1Z25	
—					No	900-TC8VABZ25		
Voltage (for driving SSR)				TRIAC ⊛	No	900-TC8VYABZ25		
				0...20 or 4...20 mA Analog Output	—	No	900-TC8ACABZ25	

* A current transformer (CT) is not provided with the unit.

⊛ When the heating and cooling function or the heater burnout alarm is used, one of the relay alarm outputs will be disabled for each function used.

⊛ For AC voltage operation only

> Typically used for alarms or cooling output in a heat/cool application



Bulletin 900-TC16 Controller Models

Bulletin No.	DIN Size	Sensor Input Type	Power Supply Voltage	Max No. of Auxiliary Outputs Supported >	Control Output Type §	Supports Heater Burnout (Open) and Heater Short-Circuit Alarm	Controller Cat. No.
900-TC16 *⊛	1/16 DIN 48 mm (W) x 48 mm (H) x 78 mm (D)	Thermocouple or RTD	100... 240V AC	2	Relay Output	Yes ‡	900-TC16RGTU25
					TRIAC ⚡	Yes ‡	900-TC16YGTZ25
					Voltage output (for driving SSR)	Yes ‡	900-TC16VGTZ25
					0...20 or 4...20 mA Analog Output	No	900-TC16ACGTZ25
		Thermocouple or RTD	24V AC/DC	2	Relay Output	Yes ‡	900-TC16RGTU25
					Voltage output (for driving SSR)	Yes ‡	900-TC16VGTU25
					0...20 or 4...20 mA Analog Output	No	900-TC16ACGTZ25
					Relay	Yes ‡	900-TC16RABZ25
		Analog Current & Voltage 0...20 and 4...20 mA 0...5, 1...5, and 0...10V DC	100... 240V AC	2	TRIAC ⚡	Yes ‡	900-TC16YABZ25
					Voltage (for driving SSR)	Yes ‡	900-TC16VABZ25
			0...20 or 4...20 mA Analog Output		No	900-TC16ACABZ25	
			24V AC/DC		Relay	Yes ‡	900-TC16RABU25
Voltage (for driving SSR)	Yes ‡	900-TC16VABU25					
0...20 or 4...20 mA Analog Output	No	900-TC16ACABU25					

- * A current transformer (CT) is not provided with the unit.
- ⊛ When the heating and cooling function or the heater burnout alarm is used, one of the relay alarm outputs can be used as the heating or cooling output or heater burnout alarm.
- ‡ To implement the single-phase or three-phase heater burnout and heater short alarm function, an option module must be inserted into the 900-TC16 controller. For a list of 900-TC16 option modules, refer to the Option Units table, page 9-198 The heater burnout and heater short alarm is available by mounting the appropriate option module into any 900-TC16 controller that supports (yes) the heater burnout (open) or heater short-circuit feature.
- § The Bulletin 900-TC16 can have a second ON/OFF control output (SSR) by adding an option unit to the controller. Refer to Option Units table on page 9-198.
- ⚡ For AC voltage operation only
- > Typically used for alarms or cooling output in a heat/cool application

Bulletin 900-TC32 Controller Models

Bulletin No.	DIN Size	Power Supply Voltage	Max No. of Alarms Supported ❖	Control Output Type	Supports Heater Burnout (Open) and Heater Short-Circuit Alarm	Controller Cat. No. with Thermocouple and Platinum RTD Support
900-TC32 ⊛+	1/32 DIN 48 mm (W) x 24 mm (H) x 100 mm (D)	100... 240V AC	1	Relay Output	No	900-TC32RGTZ25
				Voltage output (for driving SSR)		900-TC32VGTZ25
		24V AC/DC	1	Relay Output	No	900-TC32RGTU25
				Voltage output (for driving SSR)		900-TC32VGTU25
		100... 240V AC	RS485	Relay Output	No	900-TC32CRGTZ25
				Voltage output (for driving SSR)		900-TC32CVGTZ25
		24V AC/DC	RS485	Relay Output	No	900-TC32CRGTU25
				Voltage output (for driving SSR)		900-TC32CVGTU25

- ⊛ If the heating/cooling function is used, ALM1 will be used for the cooling control output and so the alarm output relay will not be available.
- + Cat. Nos. with a C designator (e.g., Cat. No. 900-TC32C___) include RS-485 communications, but do not have an alarm (or cooling) output.
- ❖ Typically used for alarms or cooling output in a heat/cool application

Bulletin 900-TC
Digital Temperature Controller
 Product Selection/ Accessories

Option Units (Bulletins 900-TC8 and 900-TC16 — Only One Option Unit per Controller)

The unit provides communications or event input functionality.

Bulletin No.	Name	Function	Cat. No.
900-TC8	Communications Unit	RS-232C communications ‡	900-TC8232(B)❖
		RS-485 communications	900-TC8COM(B)❖
	Event Input Unit	Event input⌘	900-TC8EIM
900-TC16	Communications and 1-Phase Heater Burnout Unit and Heater Short	RS-485 communications with single-phase heater burnout (open) and heater short-circuit failure detection †	900-TC16NCOM(B)▲§
	Event Input Unit with 1-Phase Heater Burnout and Heater Short	Event Input with single-phase heater burnout (open) and heater short-circuit failure detection⌘ †	900-TC16NEIM(B)▲
	Event Input Unit	Event Input⌘	900-TC16NACEIM(B)▲
	Communications Unit	RS-485 communications	900-TC16NACCOM(B)▲§
	Communications and 3-Phase Heater Burnout and Heater Short Unit	RS-485 communications with 3-phase heater burnout (open) and heater short-circuit failure detection	900-TC16NCOMP3(B)▲§
	Communications and Second Voltage (SSR) Output Unit	RS-485 communications and a second voltage (SSR) output	900-TC16NCOMV2(B)▲§
	1-Phase Heater Burnout and second voltage (SSR) output	1-Phase Heater burnout (open) and heater short-circuit failure detection with a second control voltage (SSR) output	900-TC16P1V2(B)▲

‡ Enables direct RS-232 connection to personal computer using 900Builder™ Lite software. A Cat. No. 900-CP1X cable or equivalent is also required.

⌘ Provides two event inputs. Allows selecting up to 4 different pre-configured set points, controller Run/Stop or Auto/Manual mode, from 2 external inputs.

† Heater burnout is not available for 0...20 or 4...20 mA analog output style 900-TC16 controllers such as the 900-TC16AC.

❖ To obtain 57.6 k baud rate, Series B communication units must be used with any 900-TC8 controller catalog number from the Product Selection table on the previous page.

▲ Series B option units must be used with Series B 900-TC16 controllers. Series A option units cannot be used with Series B controllers and vice versa.

§ Series B provides 57.6 K baud rate.

Accessories

Current Transformer (Use with Bulletins 900-TC8 and 900-TC16 Only for Heater Burnout or Heater Short)

For Use With Bulletin No.	Hole Diameter*	Cat. No.
900-TC8, 900-TC16	5.8	900-CT1
	12.0	900-CT2

* The hole diameter is the only functional difference between the Cat. No. 900-CT1 and the Cat. No. 900-CT2. Current output to controller is the same.

Interface Converter (RS-232/USB to RS-485) Model

Converts personal computer RS-232 or USB (Ser. B or later) communications to RS-485. Use for interface with a single Bulletin 900-TC8, or Bulletin 900-TC16 with a Cat. No. 900-TCxxCOM unit installed or a single Cat. No. 900-TC32C_ designated controller. Also allows interface to up to 31 controllers connected on a RS-485 link/network. See 900-CONV for additional details.

Bulletin No.	Size	Power Supply Voltage	Cat. No.
900-CONV	30 mm (W) x 80 mm (H) x 78 mm (D)	100...240V AC	900-CONVZ25
		24V AC/DC	900-CONVU25

RS-232 Interface Cable

Allows connection between a 900-TC8 with a 900-TC8232 option unit and a PC using 900Builder Lite software or PC with software and a 900-CONV RS232-to-RS485 converter.

Accessory	Cat. No.
RS-232 cable with 9-pin female D shell and 3 flying leads (3 m)	900-CP1X



900Builder™ Lite Personal Computer Configuration Software for Bulletin 900-TC Controllers

Free software. Allows online configuration and monitoring (direct or network) plus program upload/download capability to/from PC disk media for any Bulletin 900-TC8, 900-TC16, or 900-TC32 controller.

Note 1: To obtain the free software, go to <http://ab.rockwellautomation.com/Sensors-Switches/Temperature-Sensors/900Builder-Lite-Temperature-Controller-Software>

Note 2: Version 1.2 of 900Builder Lite is required to configure 900-TC8 and 900-TC16 Series B controllers. 900 BuilderLite Version 1.1 saved parameter cannot be downloaded to a Series B controller and 900Builder Lite Version 1.1 cannot be used with Series B controllers. Version 1.3 must be used for 900-TC32 Series B. Version 1.2 or later must be used with the Series B 900-TC8 and 900-TC16. Version 1.1 must be used with Series A 900-TC8 and 900-TC16.

Accessory	Cat. No.
Free configuration software for Bulletin 900-TC8, 900-TC16, and 900-TC32 controllers.	900-BLDLTSW1

USB Direct Communication Cable

This cable allows direct 1-to-1 (no network capability) communication between a PC USB port and the 4-pin serial port located at the bottom of a Bulletin 900-TC16 or a 900-TC8 controller. No communication option unit is required. The cable can be used with the 900Builder™ Lite software to modify parameters, monitor controller operation, and upload or download parameters to/from PC disk media.

Note: Series B controllers allow simultaneous use of this cable and controller network communications.

Accessory	Cat. No.
USB-Serial Conversion Cable	900-CPOEM1

USB-Serial Conversion Cable (900-CPOEM1)

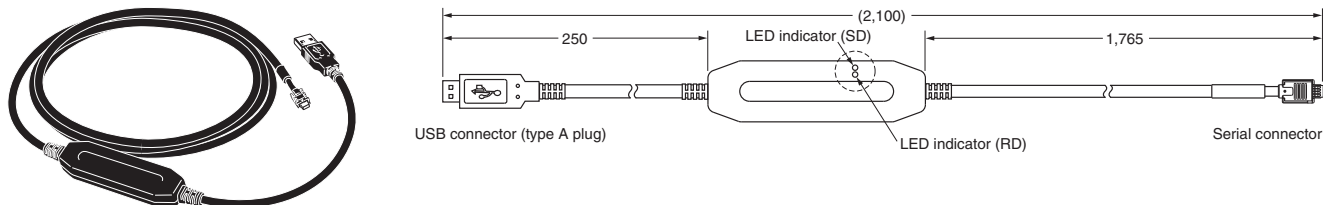



- **Note:** To use the cable you must first download a USB driver (free download). To get the driver, go to <http://www.ab.com> and use the A-Z Product Directory under "Resources" to locate the Temperature Controller home page. When the Bulletin 900-TC Single-Loop Controller website is displayed, go to "Get Software" selection in the upper right and click on 900-CPOEM1 driver. Follow the instructions.
- Do not connect or disconnect the Conversion Cable connector repeatedly over a short period of time. The computer may malfunction.
- Do not connect the Conversion Cable through a USB hub. Doing so may damage the Conversion Cable.
- Do not use an extension cable to extend the Conversion Cable length when connecting to the computer. Doing so may damage the Conversion Cable.
- When using this cable with 900 BuilderLite software, the software communication settings (ComSet) must be as follows:

Communications Parameter	Set-up Value
Unit No.	.01
Baud Rate	38.4 (kbps)
Data Length	7 (bits)
Stop Bits	2
Parity	Even

Specifications §
 General Functions
 Bulletin 900-TC8

Operation Indicators

1. SUB 1 - Lights when auxiliary 1 output is ON
 SUB 2 - Lights when auxiliary 2 output is ON
 SUB 3 - Lights when auxiliary 3 output is ON
2. HA (red heater burnout alarm display) - Lights when a heater burnout is detected. The heater burnout alarm remains ON by setting the heater burnout latch. To reset, turn the power supply OFF and then ON or set the heater burnout alarm value to 0.0 A.
3. OUT1, OUT2 (amber control output 1, control output 2) - lights when control output 1 and or control output 2 are ON.
4. STOP (amber stop) - lights when control of the Bulletin 900-TC8 has stopped. During control, this indicator lights when an event or run/stop function has become stopped. Otherwise, this indicator is out.
5. CMW (amber communications writing control) - Lights when communications writing is enabled and is out when it is disabled.
6. MANU (Manual Mode) - Lights when the controller mode is in manual
7.  (Key) - Lights when the settings change protection in ON
 Keys disabled.

Temperature Unit

Temperature units are displayed when the display unit parameter is configured for temperature. Indication is determined by the currently selected temperature unit parameter set value. When this parameter is set to °C, c is displayed, and when set to °F, f is displayed.

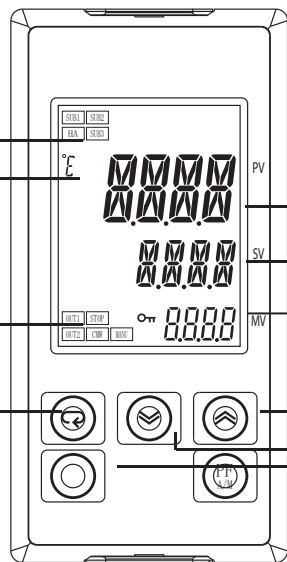

No. 1 Display (Green, Red, Amber)
 Displays the process value or parameter type.

No. 2 Display (Green)
 Displays the set point, manipulated variable, or configured value (setup) of the parameter.

No. 3 Display (Amber)
 Displays manipulated variable soak time remaining or multi SP.

Up Key
 Each press of this key increases values displayed on the No. 2 display. Holding down this key continuously increases values.

Down Key
 Each press of this key decreases values displayed on the No. 2 display. Holding down this key continuously decreases values.



Function Group Selection Key
 Press this key to select the setup function group. This setup function group is selected in order operation function group ↔ adjustment function group ↔ communications setting function group.

Function Group + Mode Keys
 This key combination sets the Bulletin 900-TC8 to the protect function group.

Mode Key
 Press this key to select parameters within each function group.

4-pin Serial Port for USB Cable (900-CPOEM 1)

Operation Indicators

1. SUB 1 - Lights when auxiliary 1 output is ON
 SUB 2 - Lights when auxiliary 2 output is ON
2. HA (red heater burnout alarm display) - Lights when a heater burnout is detected. The heater burnout alarm remains ON by setting the heater burnout latch. To reset, turn the power supply OFF and then ON or set the heater burnout alarm value to 0.0 A.
3. OUT1, OUT2 (amber control output 1, control output 2) - lights when control output 1 and or control output 2 are ON.
4. STOP (amber stop) - lights when control of the Bulletin 900-TC16 has stopped. During control, this indicator lights when an event or run/stop function has become stopped. Otherwise, this indicator is out.
5. CMW (amber communications writing control) - Lights when communications writing is enabled and is out when it is disabled.
6. MANU (Manual Mode) - Lights when the controller mode is in manual
7.  (Key) - Lights when the settings change protection in ON
 Keys disabled.

Temperature Unit

Temperature units are displayed when the display unit parameter is configured for temperature. Indication is determined by the currently selected temperature unit parameter set value. When this parameter is set to °C, c is displayed, and when set to °F, f is displayed.

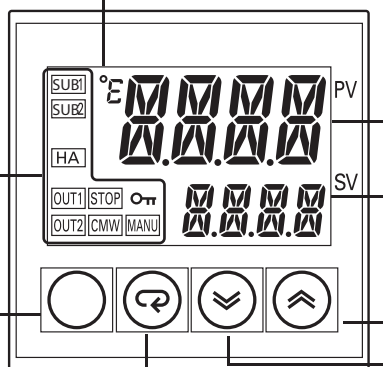

No. 1 Display (Green, Red, Amber)
 Displays the process value or parameter type.

No. 2 Display (Green)
 Displays the set point, manipulated variable, or configured value (setup) of the parameter.

Up Key
 Each press of this key increases values displayed on the No. 2 display. Holding down this key continuously increases values.

Down Key
 Each press of this key decreases values displayed on the No. 2 display. Holding down this key continuously decreases values.

Mode Key
 Press this key to select parameters within each function group.

Function Group + Mode Keys
 This key combination sets the Bulletin 900-TC16 to the protect function group.

Function Group Selection Key
 Press this key to select the setup function group. This setup function group is selected in order operation function group ↔ adjustment function group communications ↔ setting function group.

4-pin Serial Port For USB Cable (900-CPOEM 1)

Bulletin 900-TC
Digital Temperature Controller
Specifications

Bulletins 900-TC8, 900-TC16, and 900-TC32*

Technical/Control Ratings			
Supply Voltage (Line)	100...240V AC, 50/60 Hz	24 V AC, 50/60 Hz / 24 V DC	
Operating Voltage Range (Line)	85...110% of rated supply voltage		
Power Consumption	900-TC8	10 VA	
	900-TC16	7.5 VA	
	900-TC32	5.5 VA	
Temperature Input	Thermocouple	J, K, T, E, L, U, N, R, S, B, W and PL11 (controller applies cold junction compensation)	
	Platinum Resistance Thermometer	Pt100, JPt100 (controller RTD excitation current: approx. 1 mA) 2- or 3-wire configuration	
	Non-Contact Temperature Sensor	10...70 °C, 60...120 °C, 115...165 °C, 140...260 °C	
	Millivolt Input	0...50 mV	
900-TC8 and 900-TC16	Analog Voltage Input	1...5V DC, 0...5V DC and 0...10V DC	
	Analog Current Input	4...20 mA and 0...20 mA	
Analog Input Impedance	Current Input:	150 Ω max.	
	Voltage:	1 MΩ max.	
Control Output	Electromechanical Relay output	900-TC8	SPST-NO, 250V AC @ 5 A, 30V DC @ 10 A (max. resistive load), electrical life: 100 000 operations, min. load 5V, 10 mA
		900-TC16	SPST-NO, 250V AC @ 3 A, 30V DC @ 10 A (max. resistive load), electrical life: 100 000 operations, min. load 5V, 10 mA
		900-TC32	SPST-NO, 250V AC @ 2 A, 30V DC @ 2 A (max. resistive load), electrical life: 100 000 operations
	Voltage output (SSR compatible)	900-TC8	12V DC +15%/-20% (PNP), max. load current: 40 mA, with current limit protection Output 2 max. load current 21 mA
		900-TC16	12V DC ±15% (PNP), max. load current: 21 mA, with current limit protection
		900-TC32	12V DC (PNP), max. load current: 21 mA, with current limit protection
	Triac output (AC only)	900-TC8	SPST-No, 250V AC @ 3 A (max. resistive load)§
		900-TC16	SPST-NO, 250V AC @ 3 A (max. resistive load)§
		900-TC32	NA
	Analog Output	900-TC8	DC: 4...20 mA, 0...20 mA, max. load 600 ohms, resolution 10,000
900-TC16		DC: 4...20 mA, 0...20 mA, max. load 600 ohms, resolution 10,000	
900-TC32		NA	
Auxiliary Output	900-TC8, 900-TC16	SPST-NO, 250V AC @ 3 A, 30V DC @ 5 A (max. resistive load), electrical life: 100 000 operations, min. load 5V, 10 mA	
	900-TC32	SPST-NO, 250V AC @ 2 A, 30V DC @ 2 A (max. resistive load), electrical life: 100 000 operations, min. load 5V, 10 mA	
Event Input ‡	Contact	ON: 1K Ω (max.) OFF: 100K Ω (min.)	
	Non-contact	ON: Voltage Drop 1.5V (max.) OFF: Leakage current 0.1 mA (max.)	
Control Method	ON/OFF control or 2-PID (auto-tune and self-tune)		
Configuration Method	Digital configuration using front panel keys or 900Builder Lite software for 900-TC8x and 900-TC16x, and 900-TC32x		
Indication Method	11-segment digital display and individual indicators: Bulletin 900-TC8 and 900-TC16, and 900-TC32.		
Character Height	900-TC8	Process Value Display: 11.8 mm; Set Point Display: 8.1 mm; MV Display: 5.8	
	900-TC16	Process Value Display: 11 mm; Set Point Display: 6.5 mm	
	900-TC32	Process Value Display: 7.5 mm; Set Point Display: 3.6 mm	
Indication Accuracy	Thermocouple	±0.3 % of indicated value or ±1°C, whichever greater ±1 digit max. *	
	Platinum Resistance Thermometer (RTD)	±0.2 % of indicated value or ±1°C, whichever greater ±1 digit max.	
	Analog Input (900-TC8, 900-TC16)	±0.2% FS±1 digit max.	
	CT Input (900-TC8, 900-TC16)	±5% FS±1 digit max.	
Affect of Signal Source Resistance	Thermocouple: 0.1°C/ohm max. (100 ohm max.)* Platinum RTD: 0.1°C/ohm max.		

* Unless noted, specifications apply to Bulletins 900-TC8, 900-TC16, and 900-TC32.

‡ The indication of K thermocouples in the -200...+1300 °C range, and T and N thermocouples at a temperature of -100 °C or less, and U and L thermocouples at any temperature is ±2 °C ±1 digit maximum. The indication of B thermocouples at a temperature of 400 °C or less is not specified. The indication of R and S thermocouples at a temperature of 200 °C or less is ±3 °C ±1 digit maximum.

‡ Applies to 900-TC8 or 900-TC16.

§ Electrical life: 1 million operations, Load Power Supply voltage: 75 to 250V AC (NA DC), Minimum Load: 5V, 10 mA, Leakage Current: 5 mA at 250V AC 60 Hz. 900-TC8 and 900-TC16, 0.1°C/ohm max. for all thermocouple types, 900-TC32,B, R, and S sensors: 0.2° C/ohm max. (100 ohm max.)



Bulletins 900-TC8, 900-TC16, and 900-TC32, Continued

Technical/Control Ratings	
Influence of Ambient Temperature ⁺ and Line Voltage ⁺	<ul style="list-style-type: none"> • R, S, B, W, PL11 Thermocouple Inputs: ±1% of PV or ±10°C, whichever is great, ±1 digit max. • Other Thermocouple Inputs: ±1% of PV or ±4°C, whichever is greater ±1 digit max. Note: For a Type-K thermocouple for -100°C or less ±10°C • RTD Sensors: ±1% of PV or ±2°C, whichever is greater. ±1 digit max. • Analog Inputs: ±1% of full scale ±1 digit max.
Hysteresis (Controller with Temperature Inputs)	0.1...999.9 EU (in units of 0.1 EU) ^{>}
Hysteresis (Controller with Analog Inputs)	0.01 to 99.99% FS (in units of 0.01% Full Scale)
Proportional Band (P) Controller with Temperature Inputs	0.1...999.9 EU (in units of 0.1 EU) ^{>}
Proportional Band Controller with Analog Inputs	0.1 to 999.9% FS (in units of 0.1% FS)
Integral Time (I)	0...3999 s (in units of 1 s)
Derivative Time (D)	0...3999 s (in units of 1 s) [⌘]
Control Period	0.5, 1...99 s (in units of 1 s)
Manual Reset Value	0.0...100.0% (in units of 0.1%)
Alarm Setting Range	-1999...+9999 (decimal point position depends on input type)
Sampling Period	250 ms
Other Functions	According to Controller model

[>] Engineering Unit (EU) is used as the unit after scaling. For a temperature sensor, the EU is °C or °F.
[⌘] When Robust Tuning (RT) is on, the differential is 0.0... 999.9 in units of 0.1 sec.
⁺ Conditions: Ambient temperature: -10°C to 23°C to 55°C. Voltage Range: -15% to +10% of rated voltage.

General/Environmental Ratings		
Weight (includes carton)	900-TC8	Approx. 360 g (12.7 oz.) with mounting bracket
	900-TC16	Approx. 160 g (5.6 oz.) with mounting bracket
	900-TC32	Approx. 100 g (3.5 ounces)
	900-TC8232, COM, EIM	Approx. 20 g (0.7 ounces)
	900-TC16COM, EIM	Approx. 35 g (1.2 ounces)
Ambient Temperature	-10...+55 °C (with no condensation or icing)	
Ambient Humidity	25...85%	
Storage Temperature	-25...+65 °C (with no condensation or icing)	
Insulation Resistance	20 MΩ min. (at 500V DC)	
Dielectric Strength	2300V AC, 50 or 60 Hz for 1 min. (between terminals with different charge)	
Maximum Operating Vibration	10...55 Hz, 20 m/s ² (2 G) for 10 minutes each in X, Y, and Z directions	
Maximum Shock Operating	100 m/s ² (10 G), 3 times each in X, Y, and Z directions.	
Protective Structure	Front panel: IP66 (IEC61010-1) Rear case: IP20, Terminals: IP00	
Installation Environment	Installation category II, pollution class 2 (IEC 61010-1 compliant)	
Memory Protection	EEPROM (non-volatile memory) (number of writes: 100 000)	
EMC	EMI	EN 61326
	Radiated Interference Electromagnetic Field Strength	EN 55011 Group 1, class A
	Noise Terminal Voltage	EN 55011 Group 1, class A
	EMS	EN 61326
	ESD Immunity	EN 61000-4-2
	Electromagnetic Field Immunity	EN 61000-4-3
	Burst Noise Immunity	EN 61000-4-4
	Conducted Disturbance Immunity	EN 61000-4-6
	Surge Immunity	EN 61000-4-5
	Power Frequency Magnetic Field Immunity	EN 61000-4-8
Voltage Dip/Interrupting Immunity	EN 61000-4-11	
Conformed Standards	Conforms to EN61010-1 (IEC 61010-1) and VDE 0106/part 100 (finger protection) when the terminal cover is installed, Pollution Level 2, Overcurrent Category II	

* RS-232C communications is only supported for Bulletin 900-TC8 (Cat. No. 900-TC8232 option board installed). All controllers support RS-485 communications (32 linked/networked devices) by appropriate option unit or correct controller catalog number.
[⌘] The baud rate, data bit length, stop bit length, or vertical parity can be individually set using the communications configuration function group.

Bulletin 900-TC
Digital Temperature Controller
Specifications

Communications		
Transmission Path Connection	RS485 Multiple points	
Communications Method *	900-TC8	RS-232C or RS-485 (2-wire, half duplex)
	900-TC16	RS-485 (2-wire, half duplex)
	900-TC32	RS-485 (2-wire, half duplex)
Synchronization Method	Start-stop synchronization	
Protocol	900TC proprietary or Modbus RTU Slave	
Baud Rate †	1200/2400/4800/9600/19 200, 38 400, 57 600 bps	
Data Bit Length †	7 or 8 bits	
Stop Bit Length †	1 or 2 bits	
Error Detection	Vertical Parity (None, even, odd) BCC or with ModBus CRC-16	
Flow Control	Not available	
Interface	900-TC8 *	RS-485/RS-232C
	900-TC16 *	RS-485
	900-TC32 *	RS-485
Retry Function	Not available	
Communications Response Wait Time	0...99 ms (Default: 20 ms)	
Communications Buffer	217 bytes	

* RS-232C communications is only supported for Bulletin 900-TC8 (Cat. No. 900-TC8232 option board installed). All controllers support RS-485 communications (32 linked/networked devices) by appropriate option unit or correct controller catalog number.

† The baud rate, data bit length, stop bit length, or vertical parity can be individually set using the communications configuration function group.

* The temperature controller is mounted on the flat surface of an enclosure that is rated and marked "Type 4X for Indoor Use Only"

Current Transformer (Sold Separately) Ratings (Use with Bulletins 900-TC8 and 900-TC16 Only)		
Dielectric Strength	1000V AC (1 min.)	
Vibration Resistance	50 Hz 98 m/s ² (10 G)	
Weight (includes carton)	900-CT1	Approx. 19 g (0.67 ounces)
	900-CT2	Approx. 65 g (2.3 ounces)

Heater Burnout and Heater Short-Circuit and overcurrent Failure Alarm (Use with Bulletins 900-TC8 and 900-TC16 Only—Current Transformer Required)	
Max. Heater Current	Single-Phase AC 50 A
Input Current Readout Accuracy	±5%FS ±1 digit max.
Alarm Setting Range	0.1...49.9 A (0.1 A units) ‡
Min. Detection ON or OFF Time	100 ms §

Approved Standards	
Standards	UL 61010-1, CSA C22.2 No. 1010.1

§ When the heater ON/OFF time is less than 100 ms, heater current cannot be measured and the heater burnout alarm (ON) or SSR failure alarm (OFF) will not activate.

‡ When the configured value of the alarm is 00 A, the alarm will always be OFF for heater burnout and ON for SSR failure. When the configured value is 50.0 A, the heater burnout alarm will always be ON and the SSR failure will be OFF.

USB-Serial Cable (900-CPOEM1)	
Applicable OS	Windows 2000, XP or Vista
Applicable Configuration Software	900Builder Lite
Applicable Models	Cat. No. 900-TC8, 900-TC16, and 900-TC32
USB Interface Standard	Conforms to USB Specification 1.1
DTE Speed	38400 bps
Connector Specifications	Computer: USB (type A plug) Temperature Controller : 4-pin Serial
Power Supply	Bus Power (Supplied from USB host controller)
Power Supply Voltage	5V DC
Current Consumption	70 mA
Ambient Operating Temperature	0...55 °C (with no condensation or icing)
Ambient Operating Humidity	10%...80%
Storage Temperature	-20...-60 °C (with no condensation or icing)
Storage Humidity	10%...80%
Altitude	2000 m max.
Weight	Approx. 100 g

Note: A USB driver (available free, go to: <http://ab.rockwellautomation.com/Sensors-Switches/Temperature-Sensors/Temperature-Sensor-Interface-Converter#/tab6>) must be installed in the PC before the cable can be used.



Approximate Dimensions

Approximate dimensions are shown in millimeters unless otherwise indicated. Dimensions are not to be used for manufacturing purposes.

Bulletin 900-TC8

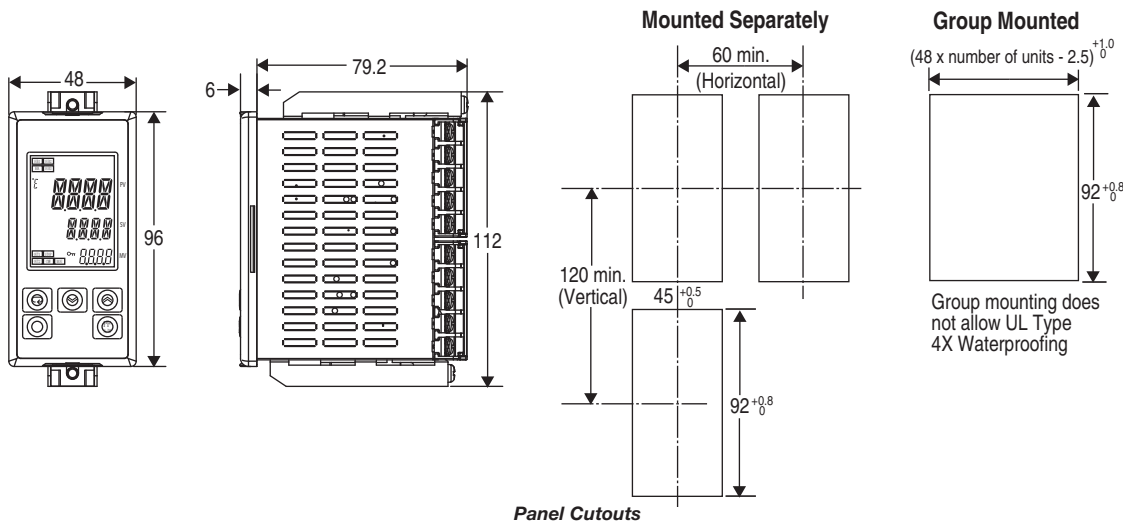

- Recommended panel thickness is 1...8 mm.
- Group mounting is not possible in the vertical direction. (Maintain the specified mounting space between controllers when they are group mounted. UL Type 4X is not possible when group mounting.)
- To mount the unit so that it is waterproof, apply the waterproof gasket to the unit
- When two or more units are mounted together, make sure that the surrounding ambient temperature does not exceed the allowable operating temperature specification.

Safety Terminal Cover*

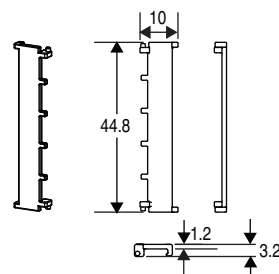

Bulletin 900-TC16

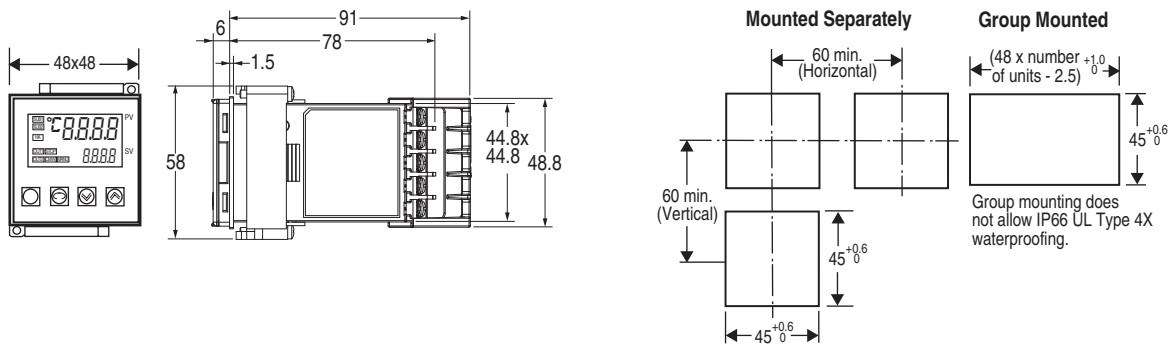

Safety Terminal Cover*

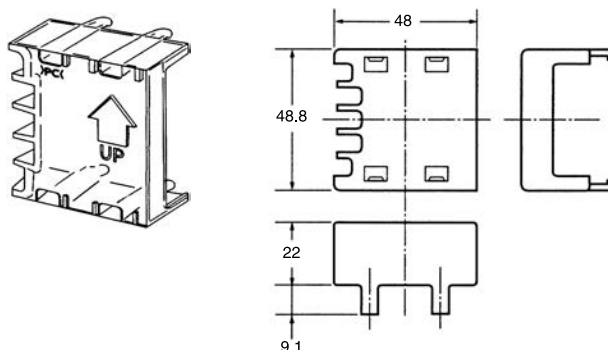

- Recommended panel thickness is 1...5 mm.
- Group mounting is not possible in the vertical direction. (Maintain the specified mounting space between Controllers when they are group mounted. IP66 UL Type 4X is not possible when group mounting.)
- To mount the unit so that it is waterproof, apply the waterproof gasket to the unit.
- When two or more units are mounted together, make sure that the surrounding ambient temperature does not exceed the allowable operating temperature specification.

* Conforms to VDE 0106 (finger protection) when installed on the controller.

Approximate dimensions are shown in millimeters unless otherwise indicated. Dimensions are not to be used for manufacturing purposes.

Bulletin 900-TC
Digital Temperature Controller
 Approximate Dimensions

Bulletin 900-TC32

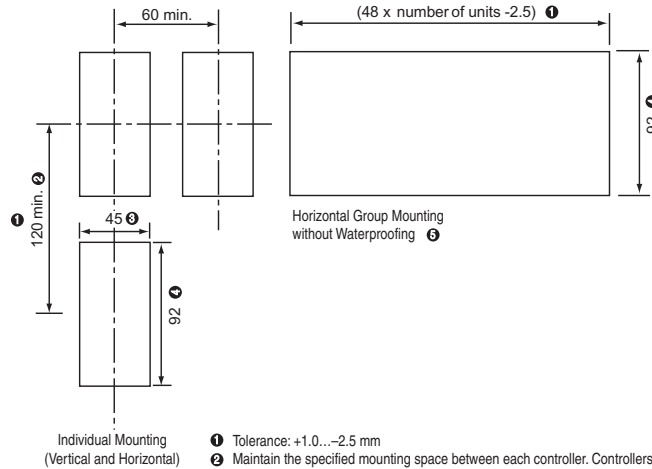
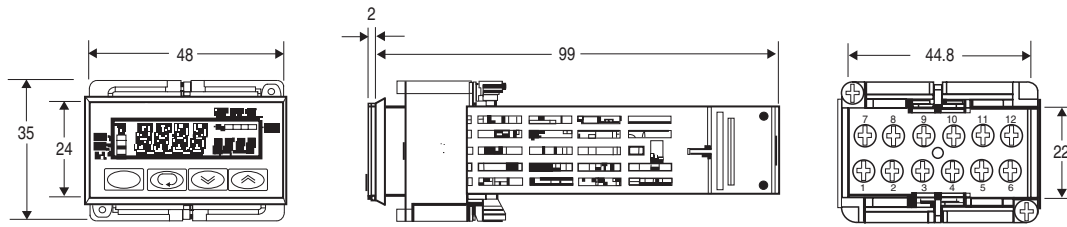

- ❶ Tolerance: +1.0...-2.5 mm
- ❷ Maintain the specified mounting space between each controller. Controllers must not be group mounted vertically.
- ❸ Tolerance: +0.6...0.0 mm
- ❹ Tolerance: +0.8...0.0 mm
- ❺ This is a configuration in which the controllers are contiguously mounted (side-by-side). Therefore, the water-proof gasket cannot provide protection.

Panel Cutouts

- Recommended panel thickness is 1...5 mm.
- When carrying out maintenance on the unit, the I/O wiring terminal block can be removed from the module with the terminal leads still attached.
- Group mounting is not possible in the vertical direction. (Maintain the specified mounting space between controllers when they are group mounted. IP66 UL Type 4X is not possible when group mounting.)
- To mount the unit so that it is waterproof, apply the waterproof gasket to the unit.
- When two or more units are mounted together, make sure that the surrounding ambient temperature does not exceed the allowable operating temperature specification.

9

Current Transformer (Sold Separately) (Bulletins 900-TC8 and 900-TC16 Only)

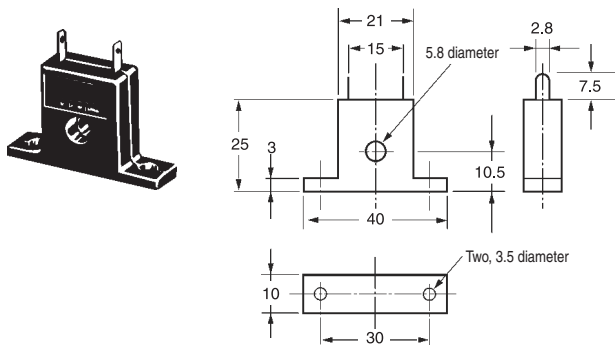

Cat. No. 900-CT1

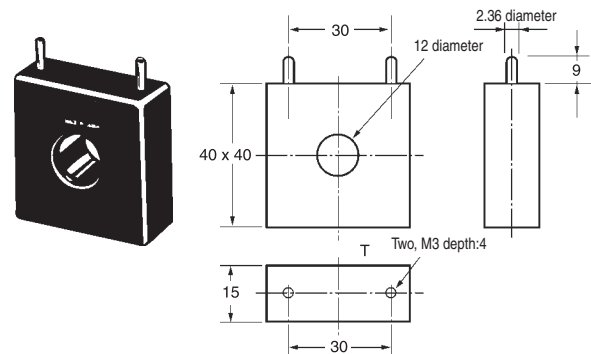

Cat. No. 900-CT2

Note: The hole diameter is the major functional difference between Cat. Nos. 900-CT1 and 900-CT2. The current output signal is the same.

Ratings	
Dielectric Strength	1000V AC for 1 min.
Vibration Resistance	50 Hz, 98 m/s ²
Weight	900-CT1: Approx. 11.5 g, 900-CT2: Approx. 50 g

900-CT1 Thru-current (I_o) vs. Output Voltage (E_o) Reference Values

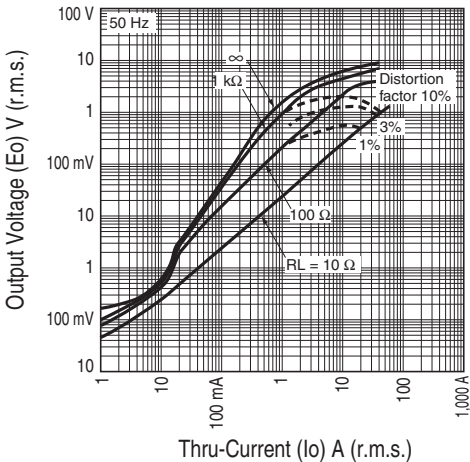

900-CT2 Thru-current (I_o) vs. Output Voltage (E_o) Reference Values

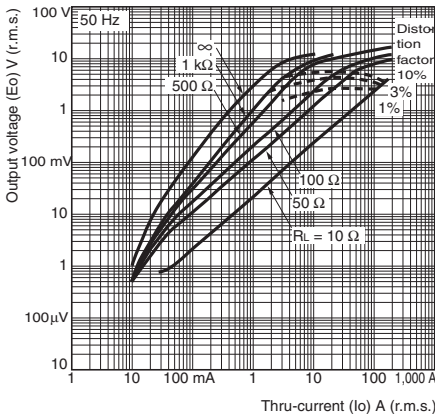

Bulletin 900-TC

Digital Temperature Controller

Wiring Terminals

Wiring Terminals — General Guidelines

Bulletins 900-TC8 and 900-TC16

- The voltage output (SSR control output) is not electrically isolated from the controller's internal circuits. When using a grounded thermocouple, do not connect the control output terminals to earth ground. If the control output terminals are connected to earth ground, errors will occur in the measured temperature values as a result of ground loop leakage current.
- Standard insulation ratings exist between any of the following: power supply terminals, input terminals, output terminals, and communication terminals. If reinforced insulation is required, provide additional insulation, such as spacial distance or material insulation, as defined by IEC 60664.
- Separate input leads and power lines to protect the Bulletin 900-TC8/900-TC16 and its lines from external noise.
- Solderless lugs are recommended when wiring to the Bulletin 900-TC8/900-TC16 wire terminals. However, if lugs are not used, the controller's screw terminals will accept two solid or stranded wires (no mixing) 14...24 AWG.
- Tighten the terminal screws using a torque 0.74...0.90 N•m.
- Use a 7.2 mm open or round solderless lug for M3.5 screws.
- Never attempt to remove the controller terminal block from the controller case. Damage may result.

Note: Input power supply available: 100...240 V AC, or 24 V AC/DC

Bulletin 900-TC8 — Wiring Terminals

Option Unit Terminals, refer to page 9-211.

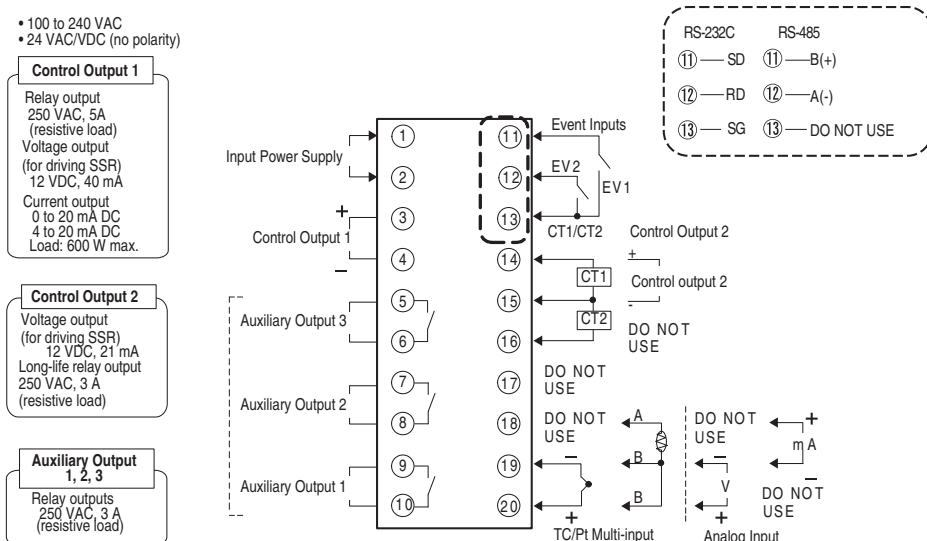

Bulletin 900-TC16 — Wiring Terminals

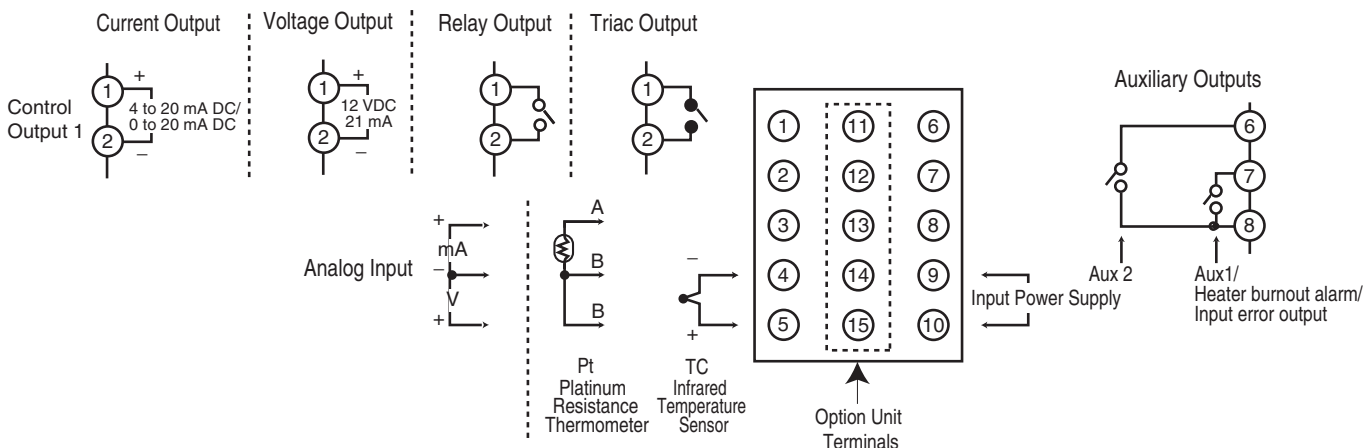

The input power supply depends on the power supply specification of the Controller and is either 100 to 240 VAC or 24 VAC/DC (no polarity).



Wiring Terminals — General Guidelines

Bulletin 900-TC16 Option Unit Terminals, refer to Option Unit Wiring

Bulletin 900-TC32 — Wiring Terminals

- The voltage output (SSR control output) is not electrically isolated from the controller's internal circuits. When using a grounded thermocouple, do not connect the control output terminals to earth ground. If the control output terminals are connected to earth ground, errors will occur in the measured temperature values as a result of ground loop leakage current.
- Standard insulation ratings exist between any of the following: power supply terminals, input terminals, output terminals, and communication terminals. If reinforced insulation is required, provide additional insulation, such as spacial distance or material insulation, as defined by IEC 60664.
- Separate input leads and power lines to protect the Bulletin 900-TC8/900-TC16 and its lines from external noise.

Note: Input power supply available: 100...240 V AC, or 24 V AC/DC

Bulletin 900-TC32

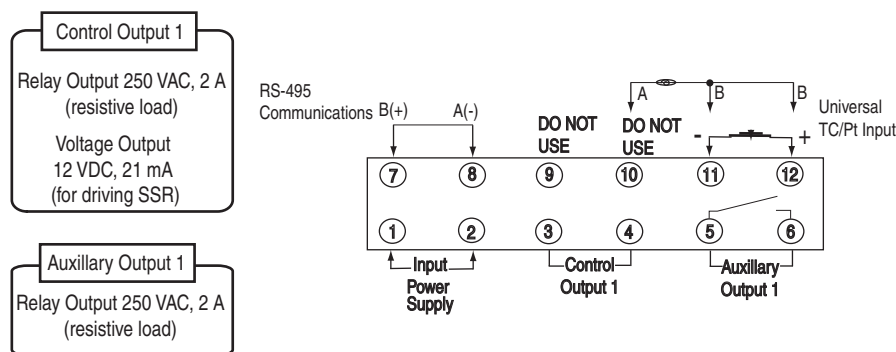

Option Units

Bulletin 900-TC8 — Option Unit Wiring

Cat. No. 900-TC8232

RS-232C Communications Unit (Series B) §

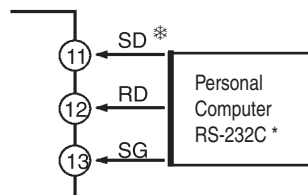

Cat. No. 900-TC8EIM

Event Input Unit

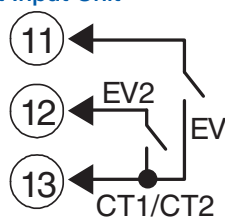

Cat. No. 900-TC8COM

RS-485 Communications Unit (Series B) ‡§

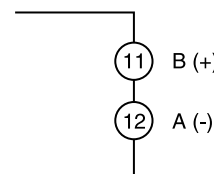

* With 900Builder Lite Software

‡ 900-CP1x or equivalent cable provides the physical connection between the PC and controller.

‡ Typically, an RS-232 to RS-485 converter such as the Cat. No. 900-CONVZ25 (see page 9-213) will be required between the personal computer (with 900Builder Lite software) and the Bulletin 900-TCx controller. In that case, a 900-CPx or equivalent cable provides the physical connection between the converter and the PC. RS-485 allows linking up to 31 controllers with a single personal computer.

§ Series B provides baud rates up to 57.6 K bps.

Bulletin 900-TC16 — Option Unit Wiring

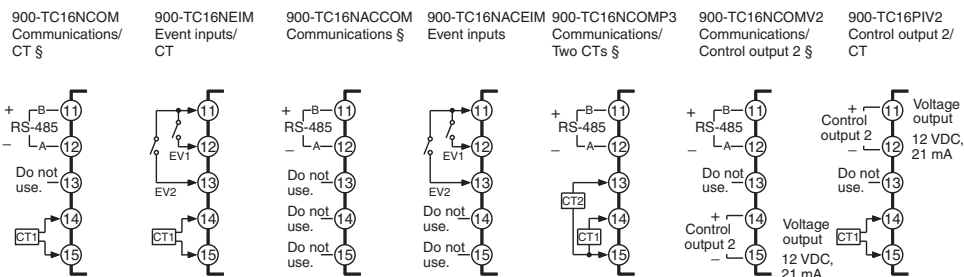

Attach the appropriate terminal labels.

§ Series B provides baud rates up to 57.6 K bps.

Installation

Bulletin 900-TC8

Panel Mounting

1. Insert the Bulletin 900-TC8 into the mounting hole in the panel from the front (panel thickness: 1 to 8 mm). Ensure the waterproof gasket is in place if this is a UL Type 4X enclosure.
2. Push the mounting bracket along the Bulletin 900-TC8 body from the rear terminals up to the panel, and secure it temporarily.
3. Tighten the screws on each mounting bracket alternately until the ratchet stops tightening.

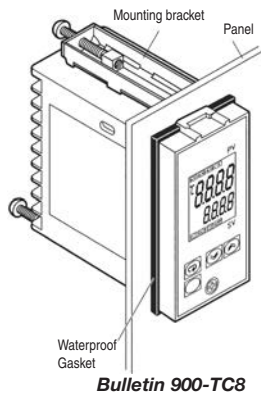

Removing the Unit from its Case

1. Insert a flat blade screwdriver into the two tool insertion holes (one on the top and one on the bottom) to release the hooks.
2. Insert the flat blade screwdriver in the gap between the front panel and rear case (two on the top and two on the bottom), and use it to pry and pull out the front panel slightly. Then, pull out on the front panel gripping both sides. Be sure not to impose excessive force on the panel.
3. When inserting the body of the Temperature Controller into the case, make sure the printed circuit boards are parallel to each other, make sure that the sealing rubber is in place, and press the 900-TC8 toward the rear case until it snaps into position. While pressing the 900-TC8 into place, press down on the hooks on the top and bottom surfaces of the rear case so that the hooks securely lock in place. Make sure that electronic components do not come into contact with the case.

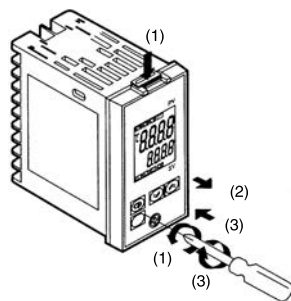

Bulletin 900-TC16

Panel Mounting

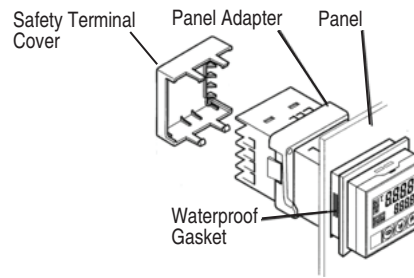

Mounting the Bulletin 900-TC16 in a Panel/Enclosure

1. Insert the Bulletin 900-TC16 into the mounting hole in the panel (panel thickness: 1 to 8 mm).
2. Ensure the waterproof gasket is in place if this is a IP66 UL Type 4X
3. Push the panel adapter along the Bulletin 900-TC16 body from the rear terminals up to the panel, and secure it temporarily.
4. Tighten the two screws on the adapter. When tightening the two screws, tighten them alternately, keeping the torque to 0.29...0.39 N•m (2.57...3.45 lb•in).

Attaching the Safety Terminal Cover

Make sure that the UP arrow mark is facing up, and then fit the terminal cover into the holes on the top and bottom of the controller. All Bulletin 900-TC16 controllers are provided with a terminal cover.

Installing the Option Units

If communications, event input, or heater burnout functions are required, mount the applicable option unit into the controller. The heater burnout function is supported on either the 900-TC16EIM or 900-TC16COM units. One option unit (max.) per controller.

Assembly Directions

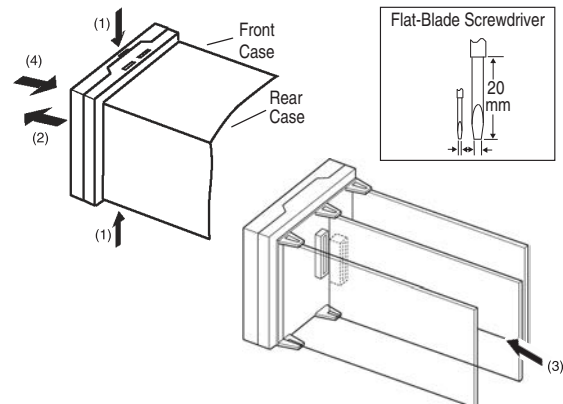

1. Insert the tools (see drawing above) into the slots (one on the top and one on the bottom) and release the case hooks
2. Insert the tool in the space between the front and rear case selections and slightly pull out the front case. Hold the top and bottom of the front case and pull it toward yourself to remove it.
3. Mount the option unit in the center position. Match the upper and lower option unit (board) retaining claws with the connection points and insert/lock the option unit in place.
4. Before inserting the unit into the panel/enclosure, confirm that the waterproof gasket is in place. Insert the front case into the rear case until you hear a click. When inserting the front case, press down the hooks on the top and bottom of the rear case so that they firmly hook together. Make sure that electronic parts do not come in contact with the case.

Bulletin 900-TC32

Panel Mounting

Note: For waterproof mounting, waterproof packing must be installed on the controller. Waterproofing is not possible when group mounting several controllers. Waterproof packing is not necessary when there is no need for the waterproofing function.

1. For waterproof mounting: Install waterproof packing on the controller.
2. Insert the 900-TC32 into the mounting hole in the panel.
3. Push the adapter from the terminals up to the panel, and temporarily fasten the 900-TC32
4. Tighten the two fastening screws on the adapter. Alternately tighten the two screws little by little to maintain a balance. Tighten the screws to a torque of 0.29...0.39 N·m.

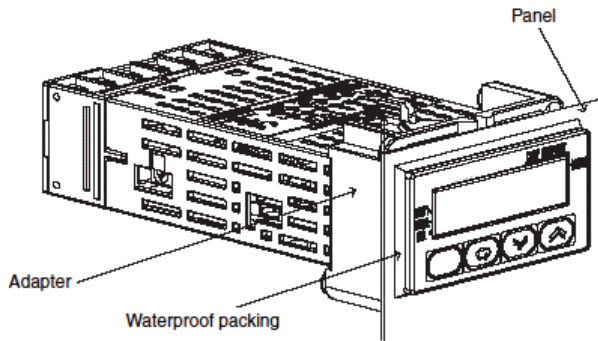

Removing and Attaching the Wiring Terminal Cover Plate

A damaged Bulletin 900-TC32 can quickly be replaced by removing the field terminal plate.

1. Insert a flat-blade screwdriver into the tool holes (one on the top and one on the bottom) to release the hooks. Do not apply excessive force.

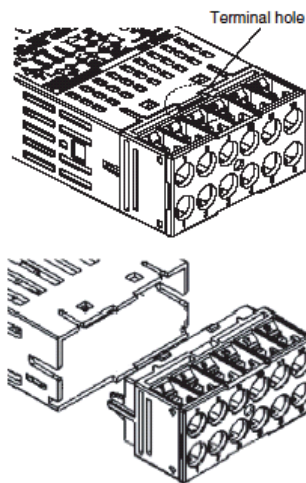

2. Pull the terminal block out while the hooks are released.

Wiring Precautions

Bulletin 900-TC32

Connect the terminals as specified below.

Terminal No.	Cables
All	AWG 24...18

The exposed current-carrying part to be inserted into terminals must be 6...8 mm.

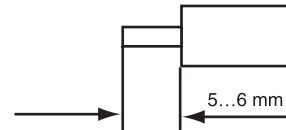

Electrical wire
 Tighten the terminal screws to the torque specified below.

Terminal No.	Screw	Maximum Tightening Torque
All	M3	0.5 N·m

Electrical Life Expectancy Curve for Electro-Mechanical Relays (Reference Values)

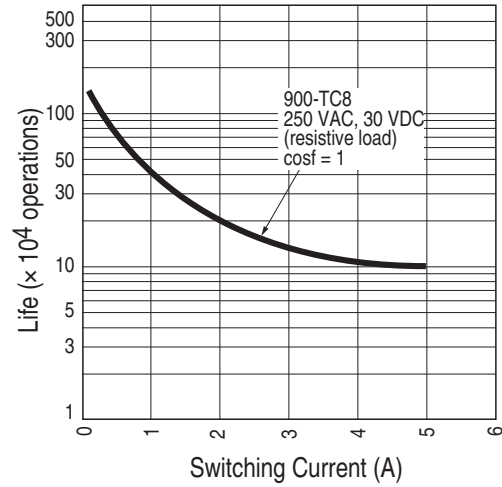
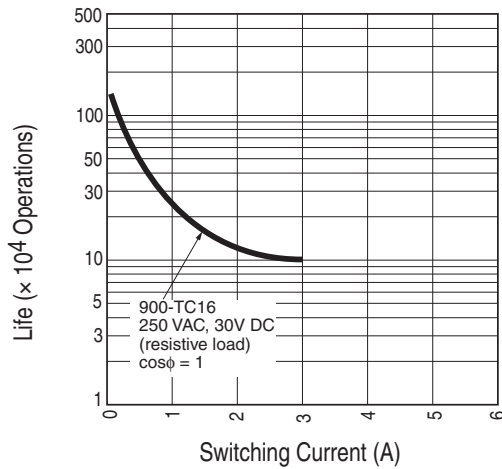

Peripheral Devices

Temperature Controller Connection to a Solid-State Relay (SSR)

The 12V DC output of a temperature controller is typically used to interface to an SSR, such as the Allen-Bradley Bulletin 700-Sx line. An SSR provides high current (e.g., 40 A) switching capability plus longer life than a mechanical relay. See the Relays and Timers Selection Guide (Publication 700-SG003x-EN-P) for additional information.

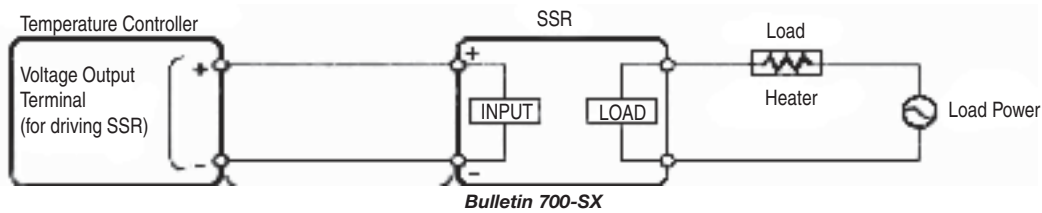

Controller Configuration from Keypad

Controller configuration of parameters can be done using the four keys on the bottom of the controller along with the two LED displays. The configuration system is structured, which means a set path must be followed to get from one parameter to another. User manuals, which provide details about configuring the Bulletin 900-TCx controllers, are available on-line at the Literature Library web site http://literature.rockwellautomation.com/idc/groups/public/documents/webassets/browse_category.hcst:

- Bulletin 900-TC8, -TC16, and -TC32: Series B, Publication 900-UM007*



Bulletin 900-CONV — Interface Converter

- Enables RS-232 or USB * (ser. B or later converter) to RS-485 Communications between a Personal Computer (PC) using 900Builder™ Lite (900-TC8/ 900-TC16) or 900Builder™ (900-TC32) Software and up to 31 Bulletin 900-TCx Controllers — ideal for industrial applications
- All signal lines have 1500V AC insulation at the RS-232C (USB: 500 V AC) and RS-485 sides using opto-couples; power supply lines have 1500V AC insulation using a transformer
- Diagnostic LEDs indicate power available and active data transmission
- On-Board wiring and data configuration diagrams simplify startup
- DIN Rail or panel mountable
- * Use of the USB mode requires the download of free software onto your PC. This software is FREE can be found online at: <http://ab.rockwellautomation.com/Sensors-Switches/Temperature-Sensors/900Builder-Lite-Temperature-Controller-Software>

Table of Contents

Product Selection this page
 Specifications..... this page
 Approximate Dimensions..... 9-214
 External Connections/Front Display Operations.... 9-215

Standards Compliance

UL 508
 CSA C22.2, No. 14
 CE Marked

Certifications

cURus Listed (File No. E 113724, Guide No. NRAQ2, NRAQ8)

Product Selection
Standard Models

Bulletin No.	Size	Power Supply Voltage	Cat. No.
900-CONV*	30 mm (W) x 80 mm (H) x 78 mm (D)	100...240V AC	900-CONVZ25
		24V AC/DC	900-CONVU25

* Converts personal computer RS-232/USB communications to RS-485. Use for interface with a single Bulletin 900-TCx, or multiple (up to 31) controllers with RS-485 communications.

Specifications

Technical/Control Ratings			
Communications Method	Master Device (PC)	RS-232C	
	Slave Device (900-TCx Controller)	RS-485 (2-wire, half duplex) (selectable)	
Synchronization Method		Start-stop synchronization	
Master Device (PC)	RS-232C Interface	Max. transmission distance	15 m
		Max. number of connectable units	1 unit
	USB Interface	Max. transmission distance	5 m or when the total time (hub delay time plus the cable delay time) is less than or equal to 70 ns
		Max. number of connectable slave units	1 unit
Slave Device (900-TCx) RS-485 Interface	Max. transmission distance	500 m	
	Max. number of connectable slave units	31 units (for multi-drop connection)	
Baud Rate		1200/2400/4800/9600/19 200/38 400 bps (Default setting: 9600)	
Data Bit Length		7 or 8 bits (Default setting: 7)	
Stop Bit Length		1 or 2 bits (Default setting: 2)	
Communications Parity		None, even, odd (Default setting: Even)	
Echoback Selection		Echoback: With/without (Default setting: Without)	
Selection Switch Response Delay		Approx. 30 ms	
General/Environmental Ratings			
Supply Voltage		100...240V AC, 50/60 Hz 24 V AC, 50/60 Hz or 24 V DC	
Operating Voltage Range		85...110% of rated supply voltage	
Power Consumption		5 VA max. 24 V AC: 3 VA max., 24 V DC: 3 W max.	
Ambient Temperature	RS-232C	-10...+55 °C (with no icing)	
	USB	0...+55 °C (with no icing)	
Ambient Humidity		25...85% (with no condensation)	
Storage Temperature		-20...+65 °C	



Bulletin 900-CONV
Interface Controller
 Specifications

Specifications, Continued

General/Environmental Ratings		
Insulation Resistance		20 MΩ min. measured at 500V DC between the following: External terminals ↔ casing RS-232C terminals ↔ RS-485 terminals power supply terminals
	Isolation Method	Communications Phototransistor coupler Power supply Isolating transformer
Dielectric Strength		1,500 V AC for 1 min. between the external terminal and case, and between the RS-232C RS-485 block power supply terminal
Noise Immunity		500 V AC for 1 min. between the RS-232C/USB block and RS-485 block
Vibration (Max.)		10...55 Hz, 0.5 mm single amplitude for 10 min. each in X, Y, and Z directions (1 G)
Shock (Max.)		98 m/s ² (10 G), 3 times each in X, Y, and Z directions
Weight		Approx. 150 g
Enclosure Rating	Front Panel Operation Parts	Conforms to IEC standards, equivalent to IP20 (when terminal cover mounted) *
	Terminals	Equivalent to VDE 0106/100 (when terminal cover mounted) *
Memory Protection		No protective functions (communications data is not protected for power interruptions during communications)
EMC	Radiated Emission	EN61326 class A
	Conducted Emission	EN61326 class A
	Immunity ESD	EN61000-4-2: 4 kV contact discharge (level 2); 8 kV air discharge (level 3)
	Immunity RF-Interference	EN61000-4-3: 10V/m (amplitude modulated, 80 MHz...1 GHz) (level 3) 10V/m (pulse modulated, 900 MHz)
	Immunity Conducted Disturbance	EN61000-4-6: 10V (0.15...80 MHz) (level 3)
	Immunity Burst	EN61000-4-3: 2 kV power-line (level 3); 2 kV I/O signal-line (level 4)
Conformity to Standards		UL508, CSA C22.2 No. 14-95 Conforms to EN50081-2, EN50082-2, EN61010-1 (IEC 61010-1) Conforms to VDE 0106/part 100 (Finger Protection), when the terminal cover is mounted.

* When USB communication is used, the cover must be removed

Approximate Dimensions

Approximate dimensions are shown in millimeters unless otherwise indicated. Dimensions are not to be used for manufacturing purposes.

Cat. No. 900-CONVZ25

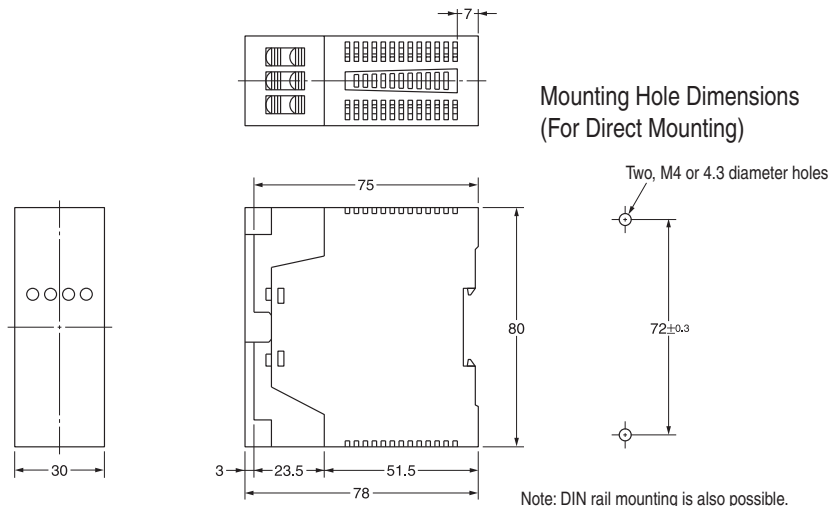
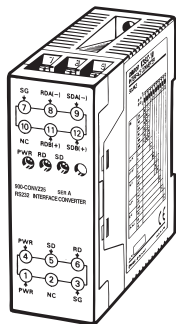

External Connections
RS-485 Connection

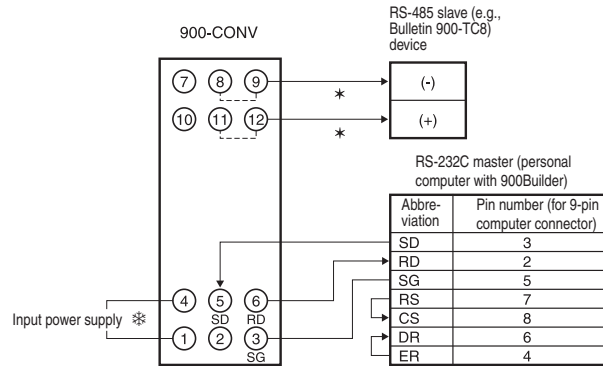

- * If RS-485 is selected as the communications method (i.e., pin 9 of the DIP switch is set to OFF), terminals 8 and 9, and terminals 11 and 12 are connected internally.
- * A 100...240 V AC, 24 V AC, or 24 V DC (not polarity sensitive) input power supply is required.

Function	Terminal Number	Name	Signal Direction	Explanation
For connecting the operating power supply	1 and 4	PWR	—	100...240V AC or 24 V AC/DC model
Connection terminals for RS-232C communications with master device (DIP switch pin 8: OFF)	3	SG	—	Connect to signal ground.
	5	SD	Input	Receives data from SD of the master device.
	6	RD	Output	Sends data to RD of the master device.
Used for RS-485 communications with slave device (DIP switch pin 9: OFF)	8	RDA (-)	Input/output	SD and RD for RS-485 (cold side) Terminals 8 and 9 are connected internally when pin 9 of the DIP switch is set to OFF.
	9	SDA (-)		
	11	RDB (+)	Input/output	SD and RD for RS-485 (hot side) Terminals 11 and 12 are connected internally when pin 9 of the DIP switch is set to OFF.
	12	SDB (+)		

Note: Terminals 2 and 10 are not used.

Connection to an RS-232C Master Device

Set the same communications conditions (baud rate, stop bits, data length, and parity) for the master device, the Interface Converter, and slave devices.

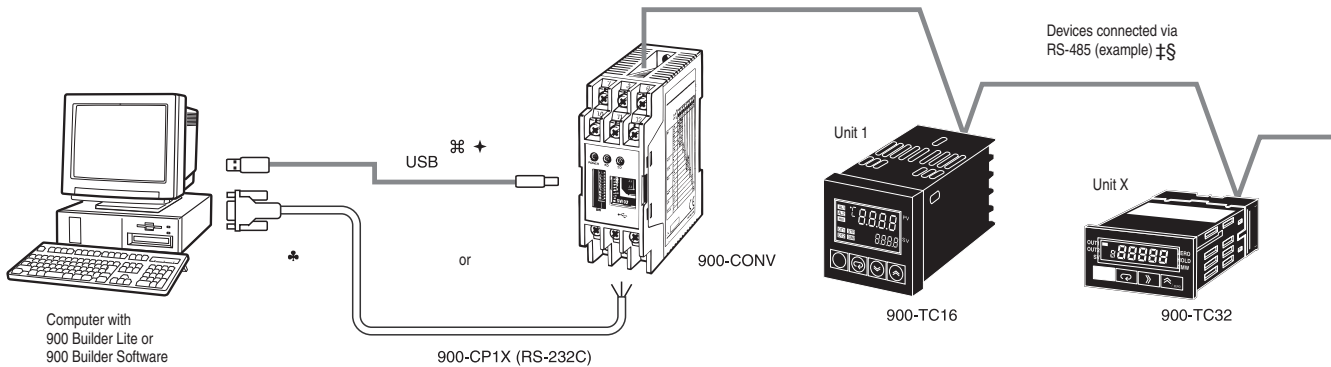

- ‡ With RS-485 communications, connect a terminating resistance (120Ω, 1/2 W recommended) to both ends of the communications link/network.
- § The Bulletin 900-TCx communications number must be set.
- * A pre-fabricated 3 m RS-232 cable with a 9-pin female D-shell connector on one end and three flying leads at the other is available from Allen-Bradley (Cat. No. 900-CP1X).
- > RS-485 allows connecting 32 devices.
- ⌘ Use a commercially available USB cable
- + To use the USB mode requires the download of "free" software into your PC. This software can be found at: <http://ab.rockwellautomation.com/Sensors-Switches/Temperature-Sensors/900Builder-Lite-Temperature-Controller-Software>

Terminal Specifications

Make sure to check the input and output specifications for the signal pins of connected devices before connecting the terminals.

Bulletin 900-CONV
Interface Controller
 Front Display/Operations

Bulletin 900-CONV Front Display/Operations

Terminal Cover



Note: Cover the terminals to prevent electric shock.

Power Indicator
 Lights (green) when line power is supplied.

Communications Setting Switch
 Used to set the communications conditions for connected devices

Switch	Setting
1	
2	Baud Rate
3	
4	
5	Data Length
6	
7	Parity
8	
9	Master Device
10	Slave Device
	Echoback

Bulletin 900-CONVx
 without Terminal Cover

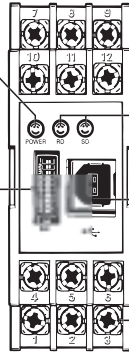

Communications Status Indicators
 RD: Amber lights when receiving RS-485 communications
 SD: Amber lights when sending RS-485 communications

USB Port

M3.5 Terminal Screw

Caution: Make sure to use the Bulletin 900-CONV with the terminal cover mounted when using in machinery that must conform to EN/IEC standards.



**Bulletin 900 — 900Builder™ Lite Software (Version 1.3*)
 FREE Personal Computer (PC) Configuration Software for
 Bulletin 900-TC8, 900-TC16, and 900-TC32 Series B
 Temperature/Process Controllers.**

- Provides a tabular fill-in-the-blanks on-line configuration and monitoring option to using the 900-TC8, 900-TC16, 900-TC32 controller's keypad and LED display
 - Simplifies controller configuration
 - Ability to save parameters to PC storage devices and retrieve as required
 - Configuration and monitoring can be done via direct or RS485 networked connection
 - Parameters can be saved as a .CSV format for use by Excel
- * Version 1.3 must be used for 900-TC32 Series B. Version 1.2 or later must be used with the Series B 900-TC8 and 900-TC16. Version 1.1 must be used with Series A 900-TC8 and 900-TC16.

Table of Contents

Product Selection this page

Product Selection

Description	Cat. No.
900Builder Lite Personal Computer Configuration Software for Bulletin 900-TC8 and 900-TC16 Temperature/Process Controllers with Enhanced Features	900-BLDLTSW1 *

* This software is a FREE and can be found online at: <http://ab.rockwellautomation.com/Sensors-Switches/Temperature-Sensors/900Builder-Lite-Temperature-Controller-Software>

Minimum Computer Hardware Requirements

- 300 MHz CPU
- 650 MB free disk space
- SVGA resolution monitor (XGA recommended)
- Microsoft Windows supported mouse
- Available serial 9-pin COM port (COM address 1 to 8) for connection to RS-232 option unit of 900-TC8 or RS-232 to RS-285 converter (Bulletin -CONVxx) for network connection to 31 Bulletin 900-TC8 and/or 900-TC15 controllers
- Available USB port for a direct connection to the 4-pin serial port of a Bulletin 900-TC8 or 900-TC16 using the 900-CPOEM1 to serial communication cable.

Computer Operating System Requirements

The following systems can be used with 900BuilderLite software:

- Microsoft Windows 2000/XP/Vista

Relays, Timers, & Temperature Controllers

Notes

9