

RKC

Konfektionierbarer Steckverbinder, M12-Kupplung mit Schraubverschluss, Konfektionierung über Schraubklemmen

Field attachable connector, M12 female connector with threaded joint, assembling with screw terminals

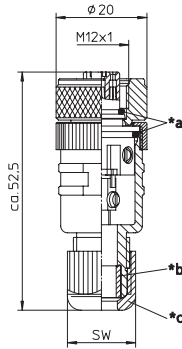

- *a O-Ring
O-ring
- *b Dichtung
gasket
- *c Hutmutter
cap nut

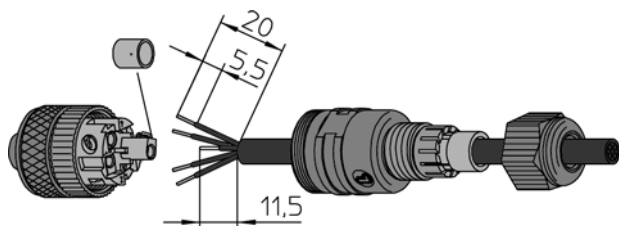

RKCW

Konfektionierbarer Steckverbinder, M12-Winkelkupplung mit Schraubverschluss, Konfektionierung über Schraubklemmen

Field attachable connector, M12 female right angle connector with threaded joint, assembling with screw terminals

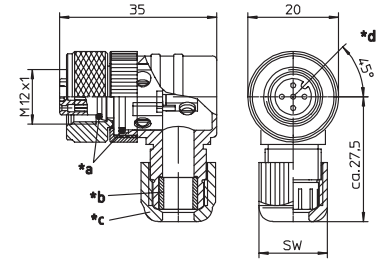

- *a O-Ring
O-ring
- *b Dichtung
gasket
- *c Hutmutter
cap nut
- *d Einsatz um 90° drehbar
insert 90° rotatable

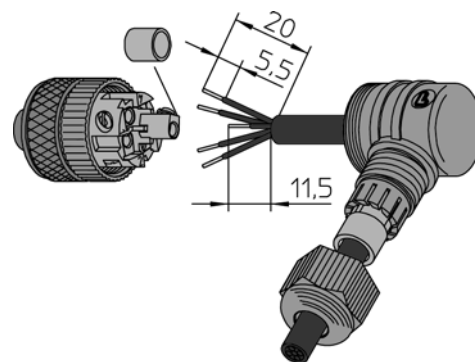

Pinbelegung
Pin assignment

3-polig
3 poles



4-polig
4 poles



5-polig
5 poles















8-polig
8 poles



Technische Daten	
Umgebungstemperatur	-25°C / +90°C
Werkstoffe	
Gehäuse / Griffkörper	PBT
Kontaktträger	PBT
Kontakt	CuZn, unterkupfert, CuSnZn 8-polig unternickelt, vergoldet
Gewindebuchse / Rändel- schraube/-mutter / Sechskant- schraube/-mutter / Hülse	CuZn, vernickelt
O-Ring	FKM
Mechanische Daten	
Schutzart	IP 67 Nur im verschraubten Zustand mit den dazugehörigen Gegen- stücken.
Anschlussart	Schraubanschluss
Anschließbarer Leiter	3- bis 5-polig max. 0,75 mm ² 8-polig max. 0,50 mm ²
Elektrische Daten	
Durchgangswiderstand	≤ 5 mΩ
Nennstrom bei 40°C	3- bis 5-polig 4 A 8-polig 2 A
Nennspannung	3- bis 4-polig 240 V 5-polig 60 V 8-polig 30 V
Bemessungsspannung	3- bis 4-polig 250 V 5-polig 63 V 8-polig 36 V
Prüfspannung	3- bis 4-polig 2,0 kV eff. / 60 s 5-polig 1,5 kV eff. / 60 s 8-polig 0,9 kV eff. / 60 s
Isolationswiderstand	> 10 ⁹ Ω
Verschmutzungsgrad	3

Technical data	
Operating temperature range	-25°C / +90°C
Materials	
Housing / Molded body	PBT
Insert	PBT
Contact	CuZn, pre-coppered, CuSnZn 8-poles pre-nickel- gold-plated
Receptacle shell / knurled screw/ nut / hexagon screw/nut / sleeve	CuZn, nickel-plated
O-ring	FKM
Mechanical data	
Degree of protection	IP 67 Only in locked position with its proper counterparts.
Mode of connection	screw terminals
Connectable conductor	3–5 poles max. 0.75 mm ² 8 poles max. 0.50 mm ²
Electrical data	
Contact resistance	≤ 5 mΩ
Nominal current at 40°C	3–5 poles 4 A 8 poles 2 A
Nominal voltage	3–4 poles 240 V 5 poles 60 V 8 poles 30 V
Rated voltage	3–4 poles 250 V 5 poles 63 V 8 poles 36 V
Test voltage	3–4 poles 2.0 kV eff. / 60 s 5 poles 1.5 kV eff. / 60 s 8 poles 0.9 kV eff. / 60 s
Insulation resistance	> 10 ⁹ Ω
Pollution degree	3

Bestellbezeichnung Designation		Polzahl Poles	Kabelverschraubung Screw joint for cable	
RKC 4/3/7	RKCW 4/3/7	3	Ø 3,0–6,5 mm /SW 15	 
RKC 4/3/9	RKCW 4/3/9		Ø 4,0–8,0 mm /SW 19	 
RKC 4/7	RKCW 4/7	4	Ø 3,0–6,5 mm /SW 15	 
RKC 4/9	RKCW 4/9		Ø 4,0–8,0 mm /SW 19	 
RKC 5/7	RKCW 5/7	5	Ø 3,0–6,5 mm /SW 15	 
RKC 5/9	RKCW 5/9		Ø 4,0–8,0 mm /SW 19	 
RKC 8/9	RKCW 8/9	8	Ø 4,0–8,0 mm /SW 19	