

# Timers

## True delay on release

### Types DBB02, PBB02

CARLO GAVAZZI



DBB02



PBB02

- Time range 60 s to 10 h - battery powered
- 3 time ranges selectable by DIP-switches
- Knob-adjustable time setting
- Automatic start after drop-out of power supply
- Repeatability:  $\leq 0.2\%$
- Output: 8 A SPDT or 8 A DPDT relay
- For mounting on DIN-rail in accordance with DIN/EN 50 022 or Plug-in
- 22.5 mm Euronorm or 36 mm Plug-in module housing
- Combined AC and DC power supply
- LED indication for relay status and power supply ON

### Product Description

Multi voltage true delay on release timer with 3 time ranges from 60 s to 10 h selectable by DIP-switches. The built-in battery (NiCd)

will be charged while the power supply is applied. For mounting on DIN-rail (DBB02) or Plug-in (PBB02).

### Ordering key

**DBB 02 C M24**

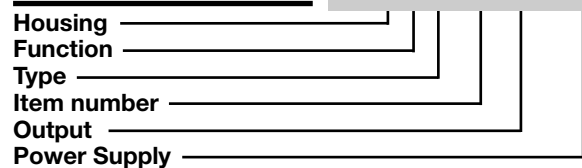

### Type Selection

Mounting	Output	Housing	Supply: 24 to 240 VAC/DC
For DIN-rail	SPDT DPDT	D - Housing D - Housing	<b>DBB 02 C M24</b> <b>DBB 02 D M24</b>
Plug-in	SPDT DPDT	P - Housing P - Housing	<b>PBB 02 C M24</b> <b>PBB 02 D M24</b>

### Time Specifications

<b>Time ranges</b> Selectable by DIP-switches	60 to 600 s 0.1 to 1 h 1 to 10 h	<b>Time variation</b> Within rated battery voltage $\leq 1\%$ Within rated power supply $\leq 0.05\%$ Within ambient temperature $\leq 0.2\%$
<b>Repeatability</b>	$\leq 0.2\%$	<b>Reset</b> Power supply applied for min. 200 ms

### Output Specifications

<b>Output</b>	SPDT or DPDT relay
<b>Rated insulation voltage</b>	250 VAC (RMS)
<b>Contact Ratings(AgNi)</b>	$\mu$
Resistive loads	AC 1 8 A @ 250 VAC DC 12 5 A @ 24 VDC
Small inductive loads	AC 15 2.5 A @ 250 VAC DC 13 2.5 A @ 24 VDC
<b>Mechanical life</b>	$\geq 2 \times 10^6$ operations
<b>Electrical life</b>	AC 1 $\geq 10^5$ operations (at 8 A, 250 V, $\cos \varphi = 1$ )
<b>Operating frequency</b>	$< 3600$ operations / h
<b>Dielectric strength</b>	
Dielectric voltage	2 kVAC (RMS)
Rated impulse withstand voltage	4 kV (1.2/50 $\infty$ s)

### Supply Specifications

<b>Power supply</b>	Overvoltage cat. III (IEC 60664, IEC 60038)
Rated operational voltage through terminals: (DBB02) A1, A2 (PBB02) 2, 10	24 to 240 VAC/DC +10% -15%, 45 to 65 Hz
<b>Voltage interruption</b>	$\leq 40$ ms
<b>Rated operational power</b>	AC supply: 3.7 VA DC supply: 1.3 W
<b>Built-in battery for time function</b>	
Nominal voltage	4.8 VDC
Min./max. battery voltage	4.2 VDC/6.2 VDC
Charging current	2 mA
Discharging current	0.5 mA
Capacity	80 mA/h

## General Specifications

<b>Power ON delay</b>	≤ 200 ms	<b>Housing</b>	Dimensions	DBB02	22.5 x 80 x 99.5 mm
<b>Power OFF delay</b>	≤ 100 ms			PBB02	36 x 80 x 94 mm
<b>Indication for</b> Power supply ON Output relays ON	LED, green LED, yellow (flashing when timing)	<b>Weight</b>			Approx 130 g
<b>Environment</b> Degree of protection Pollution degree	(EN 60529) IP 20 3 (DBB02), 2 (PBB02) (IEC 60664)	<b>Screw terminals</b> Tightening torque			(DBB02) Max 0.5 Nm according to IEC EN 60947
Operating temperature up to 265 VAC, 135 VDC from 135 VDC @5A	0 to 60 °C, R.H. < 95% 0 to 45 °C, R.H. < 95%	<b>Approval</b>			UL, CSA
Storage temperature	-30 to 80 °C, R.H. < 95%	<b>CE Mark</b>			Yes
		<b>EMC</b> Immunity Emission			Electromagnetic Compatibility According to EN 61000-6-2 According to EN 61000-6-3
		<b>Timer Specifications</b>			According to EN 61812-1

## Mode of Operation

The relay(s) operates as soon as the power supply is applied.

When the power supply is interrupted the time period starts and, at the expiration of the set time period, the relay releases.

If the power supply is reapplied before the relay released the time is reset and the relay remains ON.

The built-in battery (NiCd) will be charged while the power supply is applied.

**Note:**  
DBB02 and PBB02 should not be operated by pulses shorter than 200 ms.  
For these purposes the relays DMB01 or PMB01, operated by external contact function, should be used.

The battery test is performed on terminals + and A2 or 7 and 10.

It is recommended to connect DBB02 and PBB02 to the power supply for 42 h before it is put into regular service in order to compensate for energy losses due to, for example, a long storage period.

## Range/Time Setting

Adjust the time range setting the DIP-switches 1 and 2 as shown below.  
To access the DIP-switches open the plastic cover using a screwdriver as shown below.

**Centre knob:**  
Time setting on relative scale: 1 to 10 with respect to the chosen range.

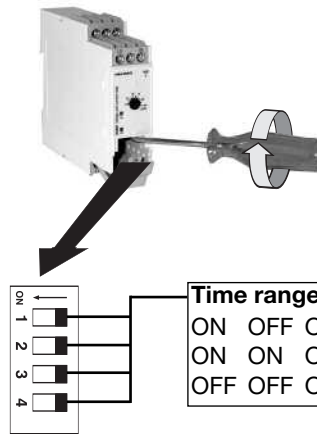

## Operation Diagram

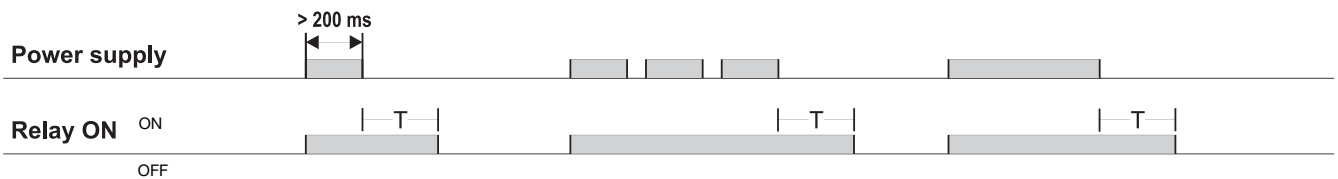

## Curves

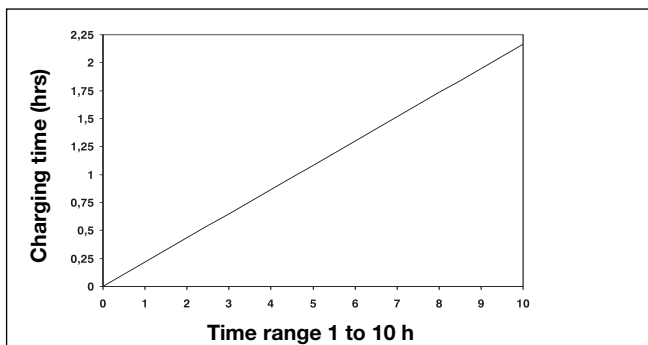
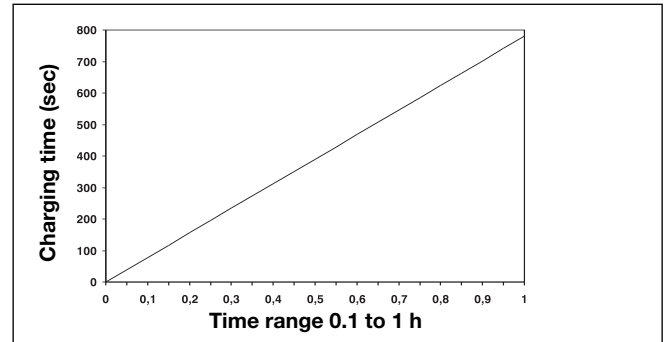
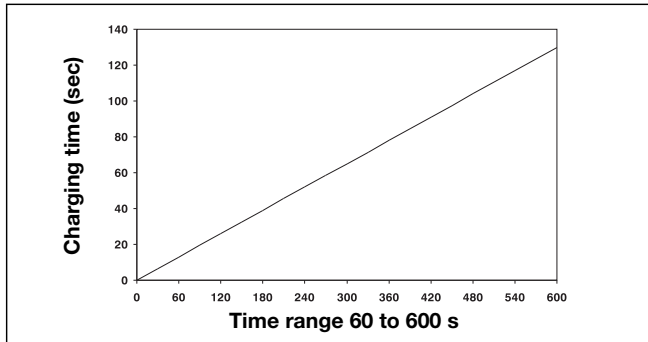

The tables indicate the charging time needed to keep the built-in battery fully charged for a certain adjusted time period.

At 5 operations: 5 x 10 h, battery charging will be 5 x 2,2 h. If the calculated charging time cannot be obtained, then the battery voltage has to be checked, as it must not drop below 4.2 VDC (min. battery voltage).

**Example**  
Adjusted time period 10h, battery charging time will be about 2.2 h.

Test can be performed on terminals + and A2 or 7 and 10.

## Wiring Diagrams

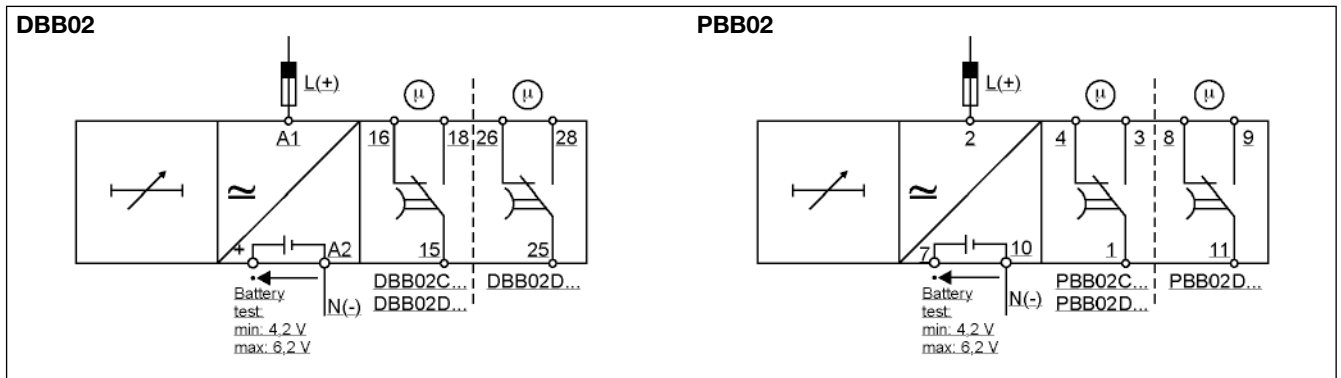

## Dimensions

