

SKM195GAL126D



SEMITRANS® 2

Trench IGBT Modules

SKM195GAL126D

Features

- Trench = Trenchgate technology
- $V_{CE(sat)}$ with positive temperature coefficient
- High short circuit capability, self limiting to $6 \times I_C$
- UL recognized, file no. E63532

Typical Applications*

- Electronic welders
- DC/DC – converter
- Brake chopper
- Switched reluctance motor

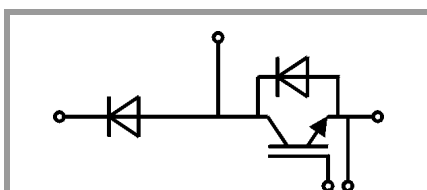

GAL

Absolute Maximum Ratings				
Symbol	Conditions		Values	Unit
IGBT				
V_{CES}	$T_j = 25\text{ °C}$		1200	V
I_C	$T_j = 150\text{ °C}$	$T_c = 25\text{ °C}$	220	A
		$T_c = 80\text{ °C}$	164	A
I_{Cnom}			150	A
I_{CRM}	$I_{CRM} = 2 \times I_{Cnom}$		300	A
V_{GES}			-20 ... 20	V
t_{psc}	$V_{CC} = 600\text{ V}$	$T_j = 125\text{ °C}$	10	μs
	$V_{GE} \leq 15\text{ V}$			
	$V_{CES} \leq 1200\text{ V}$			
T_j			-40 ... 150	$^{\circ}\text{C}$
Inverse diode				
I_F	$T_j = 150\text{ °C}$	$T_c = 25\text{ °C}$	143	A
		$T_c = 80\text{ °C}$	98	A
I_{Fnom}			100	A
I_{FRM}	$I_{FRM} = 2 \times I_{Fnom}$		200	A
I_{FSM}	$t_p = 10\text{ ms, sin } 180^{\circ}, T_j = 25\text{ °C}$		1110	A
T_j			-40 ... 150	$^{\circ}\text{C}$
Freewheeling diode				
I_F	$T_j = 150\text{ °C}$	$T_c = 25\text{ °C}$	143	A
		$T_c = 80\text{ °C}$	98	A
I_{Fnom}			100	A
I_{FRM}	$I_{FRM} = 2 \times I_{Fnom}$		200	A
I_{FSM}	$t_p = 10\text{ ms, sin } 180^{\circ}, T_j = 25\text{ °C}$		1110	A
T_j			-40 ... 150	$^{\circ}\text{C}$
Module				
$I_{t(RMS)}$			200	A
T_{stg}			-40 ... 125	$^{\circ}\text{C}$
V_{isol}	AC sinus 50 Hz, $t = 1\text{ min}$		4000	V

Characteristics						
Symbol	Conditions		min.	typ.	max.	Unit
IGBT						
$V_{CE(sat)}$	$I_C = 150\text{ A}$ $V_{GE} = 15\text{ V}$ chipelevel	$T_j = 25\text{ °C}$	1.71	2.10		V
		$T_j = 125\text{ °C}$	2.00	2.45		V
V_{CE0}	chipelevel	$T_j = 25\text{ °C}$	1	1.2		V
		$T_j = 125\text{ °C}$	0.9	1.1		V
r_{CE}	$V_{GE} = 15\text{ V}$ chipelevel	$T_j = 25\text{ °C}$	4.7	6		$\text{m}\Omega$
		$T_j = 125\text{ °C}$	7.3	9		$\text{m}\Omega$
$V_{GE(th)}$	$V_{GE} = V_{CE}, I_C = 6\text{ mA}$		5	5.8	6.5	V
I_{CES}	$V_{GE} = 0\text{ V}$ $V_{CE} = 1200\text{ V}$	$T_j = 25\text{ °C}$			2	mA
		$T_j = 125\text{ °C}$				mA
C_{ies}	$V_{CE} = 25\text{ V}$ $V_{GE} = 0\text{ V}$	$f = 1\text{ MHz}$		10.8		nF
C_{oes}		$f = 1\text{ MHz}$		0.56		nF
C_{res}		$f = 1\text{ MHz}$		0.49		nF
Q_G	$V_{GE} = -8\text{ V...} + 20\text{ V}$			1380		nC
R_{Gint}	$T_j = 25\text{ °C}$			5		Ω

SKM195GAL126D



SEMITRANS® 2

Trench IGBT Modules

SKM195GAL126D

Features

- Trench = Trenchgate technology
- $V_{CE(sat)}$ with positive temperature coefficient
- High short circuit capability, self limiting to $6 \times I_C$
- UL recognized, file no. E63532

Typical Applications*

- Electronic welders
- DC/DC – converter
- Brake chopper
- Switched reluctance motor

Characteristics						
Symbol	Conditions		min.	typ.	max.	Unit
$t_{d(on)}$	$V_{CC} = 600\text{ V}$	$T_j = 125\text{ °C}$		280		ns
t_r	$I_C = 150\text{ A}$	$T_j = 125\text{ °C}$		50		ns
E_{on}	$V_{GE} = +15/-15\text{ V}$	$T_j = 125\text{ °C}$		16		mJ
$t_{d(off)}$	$R_{G\ on} = 2\ \Omega$	$T_j = 125\text{ °C}$		560		ns
t_f	$R_{G\ off} = 2\ \Omega$	$T_j = 125\text{ °C}$		70		ns
E_{off}		$T_j = 125\text{ °C}$		24.5		mJ
$R_{th(j-c)}$	per IGBT				0.16	K/W
Inverse diode						
$V_F = V_{EC}$	$I_F = 100\text{ A}$	$T_j = 25\text{ °C}$		2.00	2.50	V
	$V_{GE} = 0\text{ V}$	$T_j = 125\text{ °C}$		1.80	2.30	V
	chipllevel					
V_{F0}		$T_j = 25\text{ °C}$		1.1	1.45	V
	chipllevel	$T_j = 125\text{ °C}$		0.85	1.2	V
r_F		$T_j = 25\text{ °C}$		9	11	m Ω
	chipllevel	$T_j = 125\text{ °C}$		9.5	11	m Ω
I_{RRM}	$I_F = 100\text{ A}$	$T_j = 125\text{ °C}$		86		A
Q_{rr}	$di/dt_{off} = 2200\text{ A}/\mu\text{s}$	$T_j = 125\text{ °C}$		17		μC
E_{rr}	$V_{GE} = -15\text{ V}$	$T_j = 125\text{ °C}$		5.8		mJ
	$V_{CC} = 600\text{ V}$					
$R_{th(j-c)}$	per diode				0.32	K/W
Freewheeling diode						
$V_F = V_{EC}$	$I_F = 100\text{ A}$	$T_j = 25\text{ °C}$		2.00	2.50	V
	$V_{GE} = 0\text{ V}$	$T_j = 125\text{ °C}$		1.80	2.30	V
	chipllevel					
V_{F0}		$T_j = 25\text{ °C}$		1.1	1.45	V
	chipllevel	$T_j = 125\text{ °C}$		0.85	1.2	V
r_F		$T_j = 25\text{ °C}$		9	11	m Ω
	chipllevel	$T_j = 125\text{ °C}$		9.5	11	m Ω
I_{RRM}	$I_F = 100\text{ A}$	$T_j = 125\text{ °C}$		86		A
Q_{rr}	$di/dt_{off} = 2200\text{ A}/\mu\text{s}$	$T_j = 125\text{ °C}$		17		μC
E_{rr}	$V_{GE} = \pm 15\text{ V}$	$T_j = 125\text{ °C}$		5.8		mJ
	$V_{CC} = 600\text{ V}$					
$R_{th(j-c)}$	per Diode				0.32	K/W
Module						
L_{CE}				30		nH
R_{CC+EE}	terminal-chip	$T_C = 25\text{ °C}$		0.75		m Ω
		$T_C = 125\text{ °C}$		1		m Ω
$R_{th(c-s)}$	per module			0.04	0.05	K/W
M_s	to heat sink M6			3	5	Nm
M_t		to terminals M5		2.5	5	Nm
						Nm
w					160	g

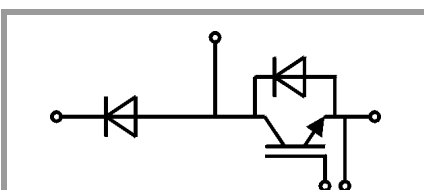

GAL

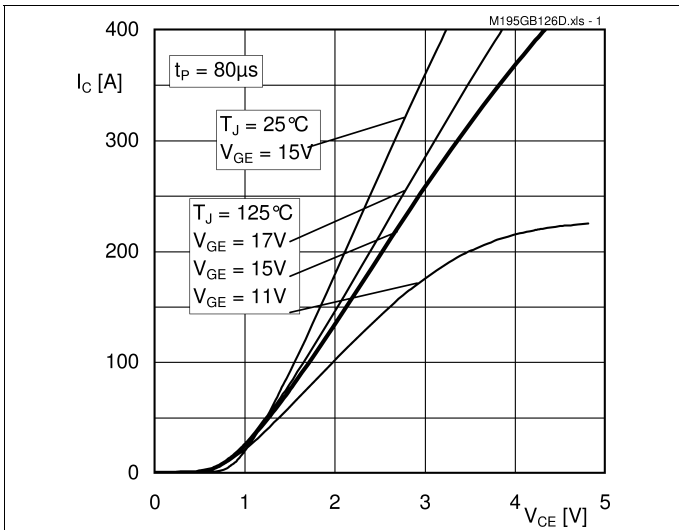

Fig. 1: Typ. output characteristic, inclusive R_{CC+EE}

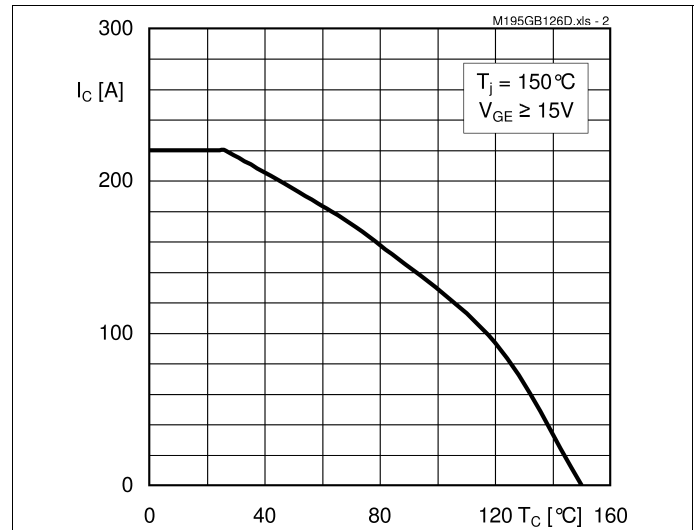

Fig. 2: Rated current vs. temperature $I_C = f(T_C)$

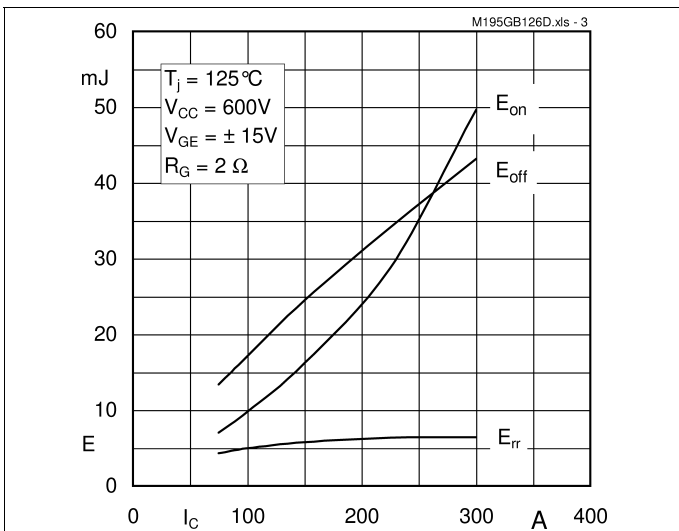

Fig. 3: Typ. turn-on /-off energy = $f(I_C)$

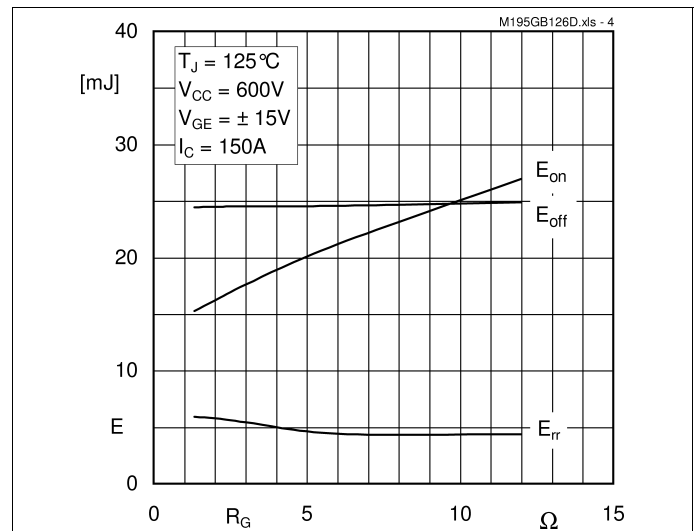

Fig. 4: Typ. turn-on /-off energy = $f(R_G)$

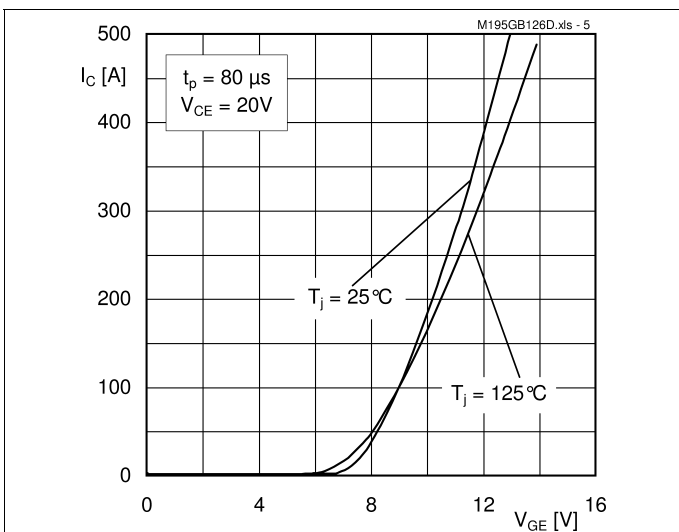

Fig. 5: Typ. transfer characteristic

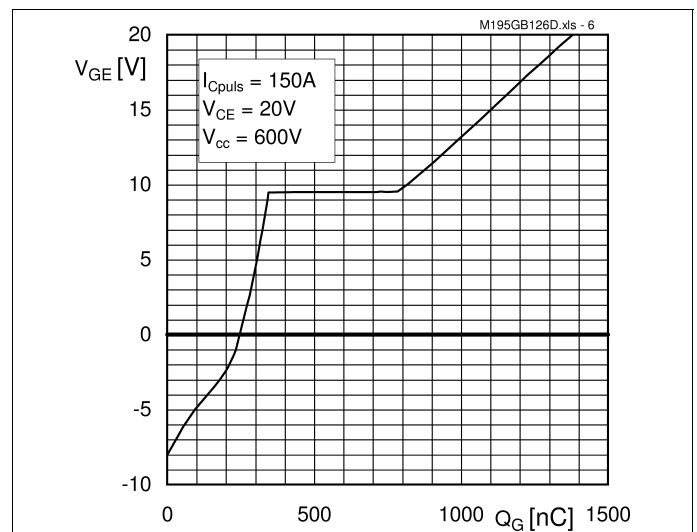

Fig. 6: Typ. gate charge characteristic

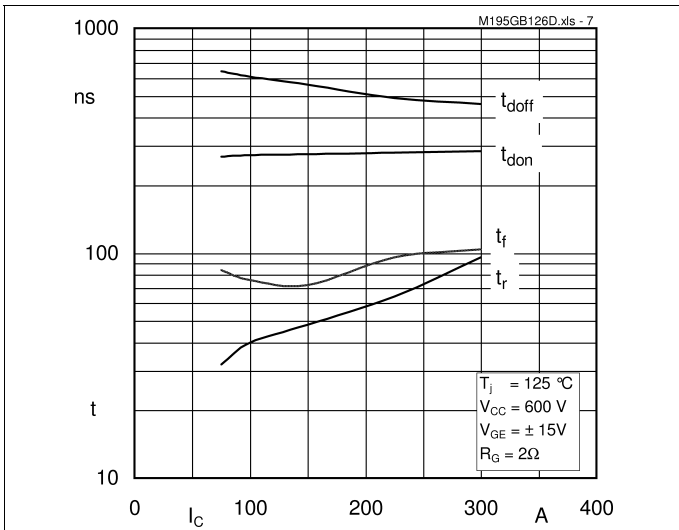

Fig. 7: Typ. switching times vs. I_C

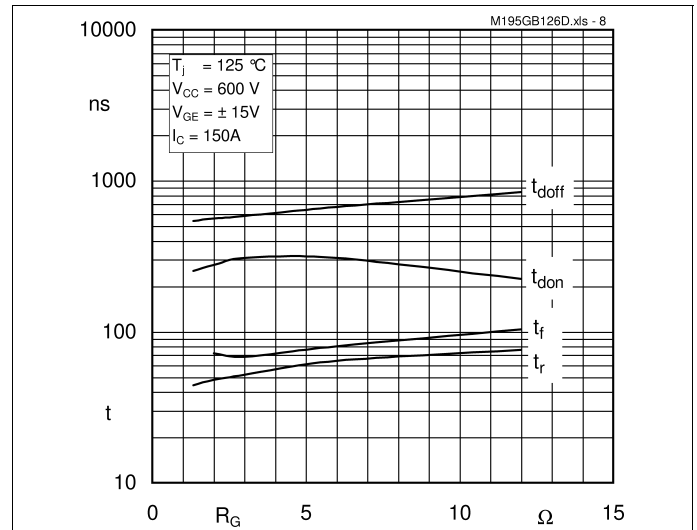

Fig. 8: Typ. switching times vs. gate resistor R_G

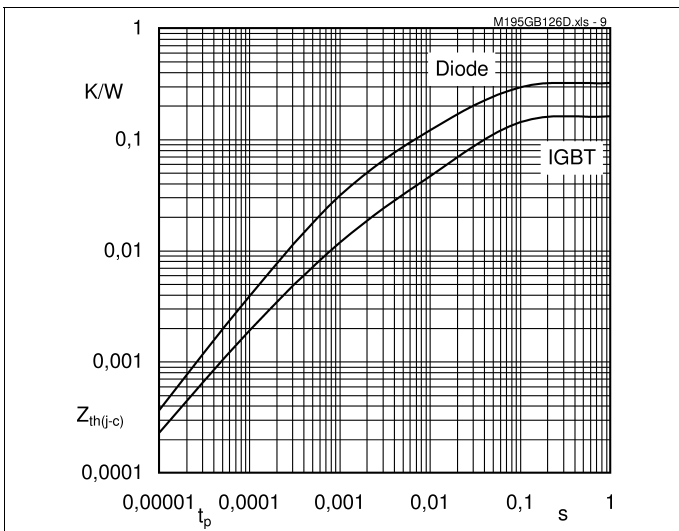

Fig. 9: Transient thermal impedance

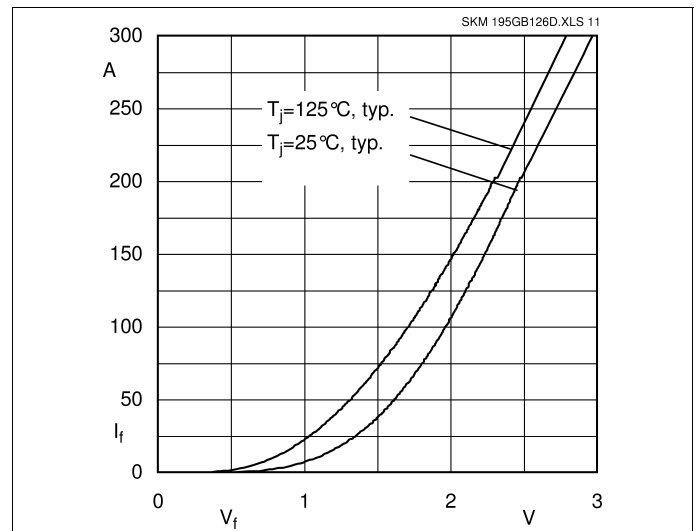

Fig. 10: Typ. CAL diode forward charact., incl. R_{CC+EE}

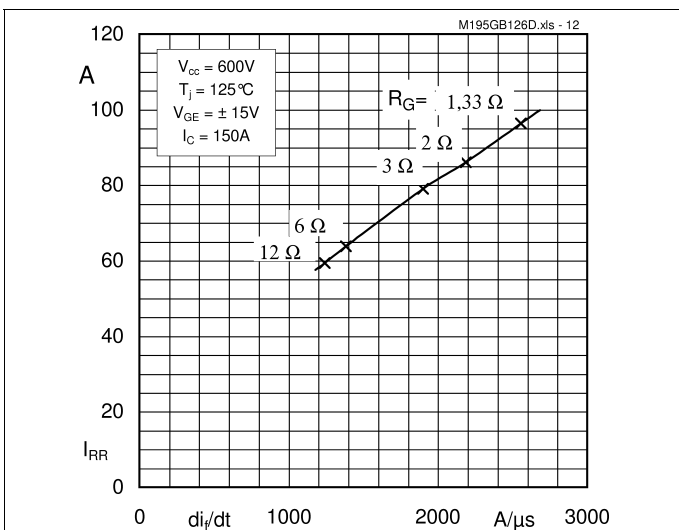

Fig. 11: Typ. CAL diode peak reverse recovery current

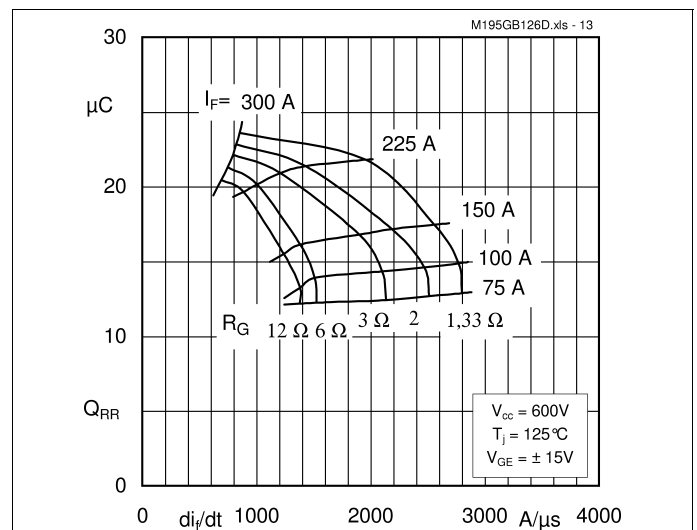
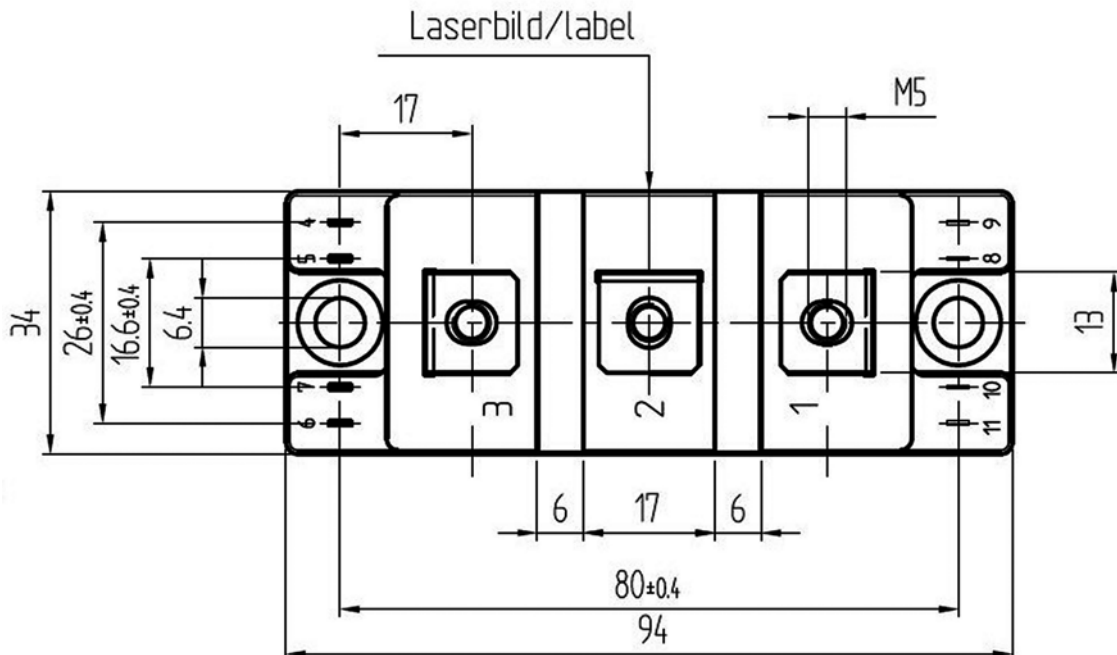
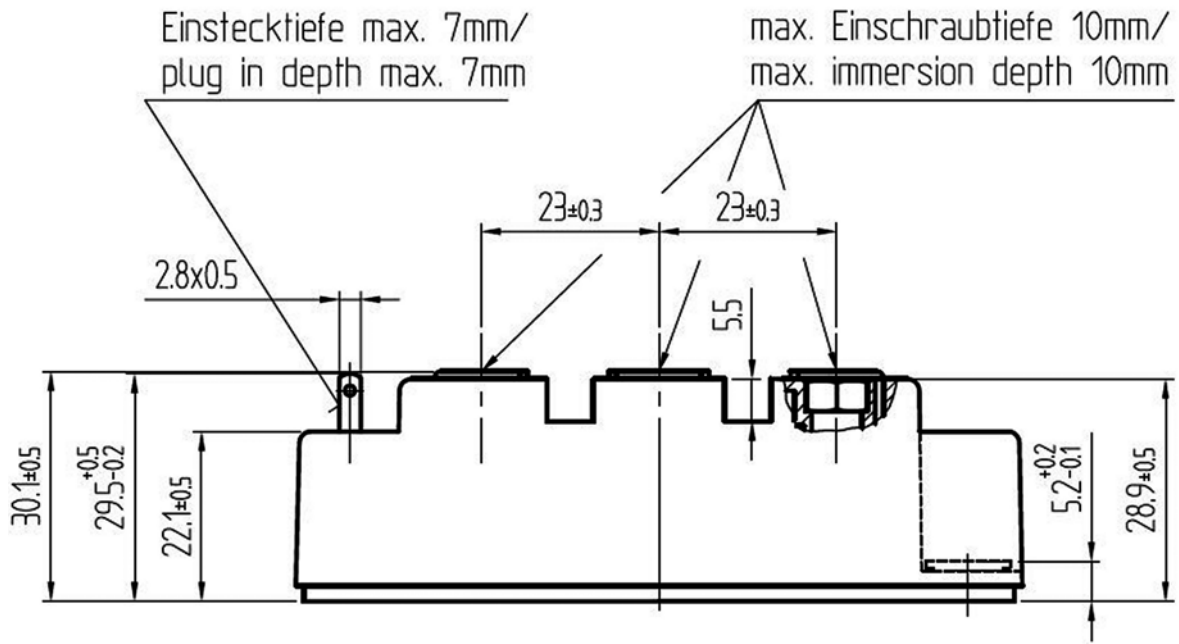
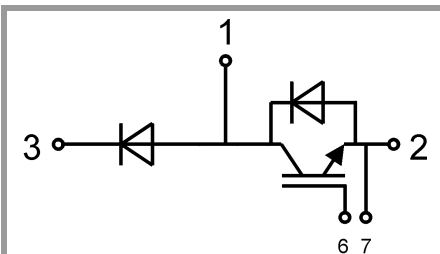

Fig. 12: Typ. CAL diode peak reverse recovery charge

SKM195GAL126D



SEMTRANS 2



GAL

This is an electrostatic discharge sensitive device (ESDS), international standard IEC 60747-1, Chapter IX

* The specifications of our components may not be considered as an assurance of component characteristics. Components have to be tested for the respective application. Adjustments may be necessary. The use of SEMIKRON products in life support appliances and systems is subject to prior specification and written approval by SEMIKRON. We therefore strongly recommend prior consultation of our staff.