

SKM 145GB128DN

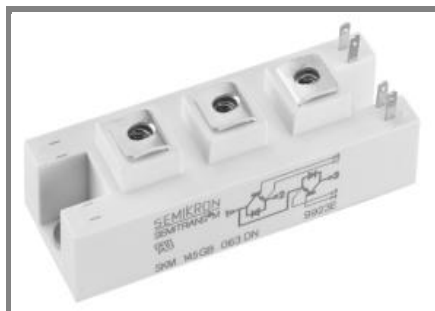

SEMITRANS™ 2N

SPT IGBT Module

SKM 145GB128DN

SKM 145GAL128DN

Preliminary Data

Features

- Homogeneous Si
- SPT = Soft-Punch-Through technology
- V_{CEsat} with positive temperature coefficient
- High short circuit capability, self limiting to $6 \times I_C$

Typical Applications

- AC inverter drives
- UPS
- Electronic welders at f_{sw} up to 20kHz

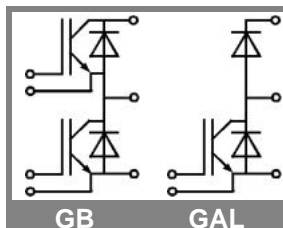

GB

GAL

Absolute Maximum Ratings		$T_c = 25\text{ °C}$, unless otherwise specified	
Symbol	Conditions	Values	Units
IGBT			
V_{CES}		1200	V
I_C	$T_c = 25\text{ (80) °C}$	190 (135)	A
I_{CRM}	$t_p = 1\text{ ms}$	200	A
V_{GES}		± 20	V
T_{vj} (T_{stg})	$T_{OPERATION} \leq T_{stg}$	-40 ... +150 (125)	°C
V_{isol}	AC, 1 min.	4000	V
Inverse diode			
I_F	$T_c = 25\text{ (80) °C}$	130 (90)	A
I_{FRM}	$t_p = 1\text{ ms}$	200	A
I_{FSM}	$t_p = 10\text{ ms; sin.; } T_j = 150\text{ °C}$	1100	A
Freewheeling diode			
I_F	$T_c = 25\text{ (80) °C}$	130 (90)	A
I_{FRM}	$T_c = 25\text{ (80) °C, } t_p = 1\text{ ms}$	350 (260)	A
I_{FSM}	$t_p = 10\text{ ms; sin.; } T_j = 150\text{ °C}$	1100	A

Characteristics		$T_c = 25\text{ °C}$, unless otherwise specified			Units
Symbol	Conditions	min.	typ.	max.	Units
IGBT					
$V_{GE(th)}$	$V_{GE} = V_{CE}, I_C = 4\text{ mA}$	4,5	5,5	6,5	V
I_{CES}	$V_{GE} = 0, V_{CE} = V_{CES}, T_j = 25\text{ (125) °C}$		0,1	0,3	mA
$V_{CE(TO)}$	$T_j = 25\text{ (125) °C}$		1 (0,9)	1,15 (1,05)	V
r_{CE}	$V_{GE} = 15\text{ V, } T_j = 25\text{ (125) °C}$		9 (12)	12 (15)	mΩ
$V_{CE(sat)}$	$I_C = 100\text{ A, } V_{GE} = 15\text{ V, chip level}$		1,9 (2,1)	2,35 (2,55)	V
C_{res}	under following conditions		9		nF
C_{oes}	$V_{GE} = 0, V_{CE} = 25\text{ V, } f = 1\text{ MHz}$		1		nF
C_{res}			1		nF
L_{CE}				25	nH
$R_{CC'+EE'}$	res., terminal-chip $T_c = 25\text{ (125) °C}$		0,75 (1)		mΩ
$t_{d(on)}$	$V_{CC} = 600\text{ V, } I_C = 100\text{ A}$		190		ns
t_r	$R_{Gon} = R_{Goff} = 9\text{ Ω, } T_j = 125\text{ °C}$		50		ns
$t_{d(off)}$	$V_{GE} = \pm 15\text{ V}$		590		ns
t_f			50		ns
$E_{on} (E_{off})$			11,5 (9,5)		mJ
Inverse diode					
$V_F = V_{EC}$	$I_F = 100\text{ A; } V_{GE} = 0\text{ V; } T_j = 25\text{ (125) °C}$		2 (1,8)	2,5	V
$V_{(TO)}$	$T_j = 25\text{ (125) °C}$		1,1	1,4	V
r_T	$T_j = 25\text{ (125) °C}$		9	13	mΩ
I_{RRM}	$I_F = 100\text{ A; } T_j = 125\text{ () °C}$		130		A
Q_{rr}	$di/dt = 3500\text{ A/μs}$		14		μC
E_{rr}	$V_{GE} = 0\text{ V}$		4,8		mJ
FWD					
$V_F = V_{EC}$	$I_F = 100\text{ A; } V_{GE} = 0\text{ V, } T_j = 25\text{ (125) °C}$		2,1 (1,8)	2,5	V
$V_{(TO)}$	$T_j = 25\text{ (125) °C}$		1,1	1,4	V
r_T	$T_j = 25\text{ (125) °C}$		9	13	mΩ
I_{RRM}	$I_F = 100\text{ A; } T_j = 25\text{ (125) °C}$		130		A
Q_{rr}	$di/dt = 0\text{ A/μs}$		14		μC
E_{rr}	$V_{GE} = V$		4,8		mJ
Thermal characteristics					
$R_{th(j-c)}$	per IGBT			0,165	K/W
$R_{th(j-c)D}$	per Inverse Diode			0,36	K/W
$R_{th(c-s)}$	per module			0,05	K/W
Mechanical data					
M_s	to heatsink M6	3		5	Nm
M_t	to terminals M5	2,5		5	Nm
w				160	g

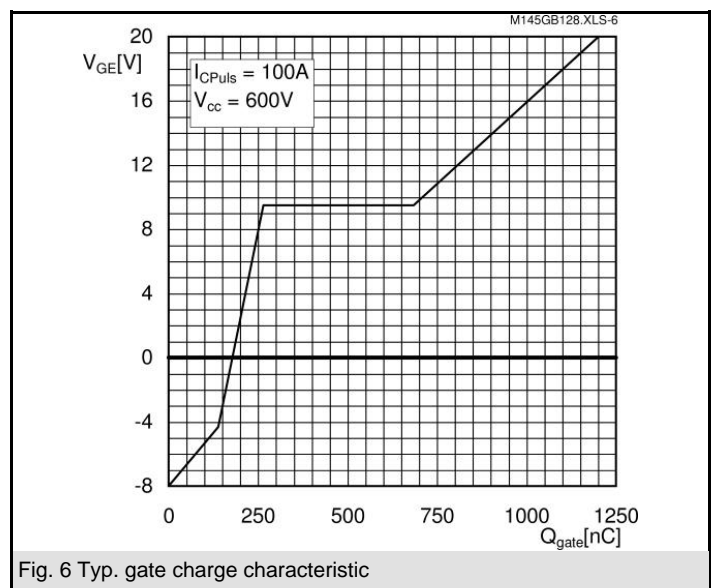
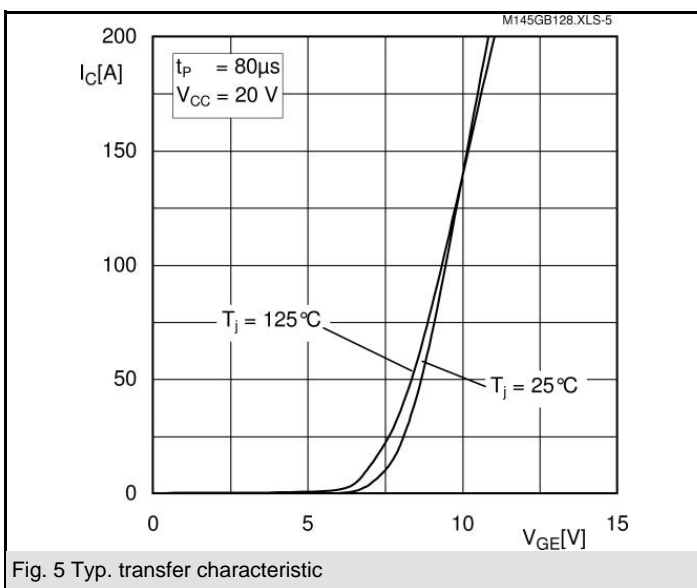
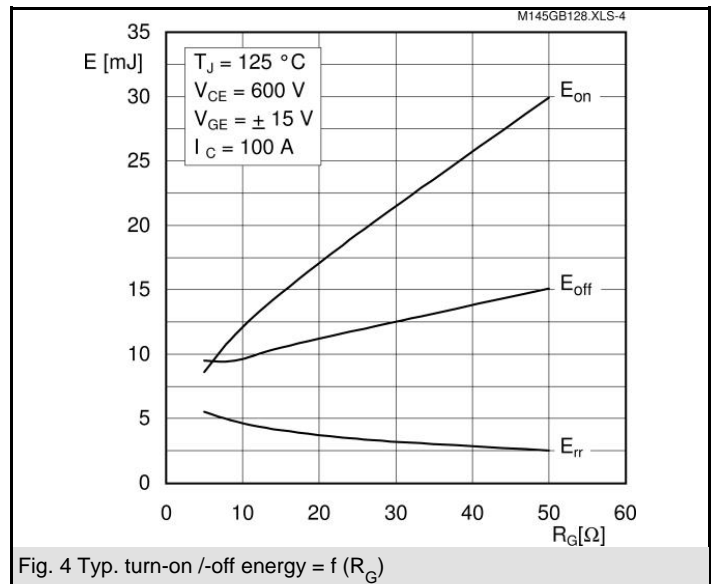
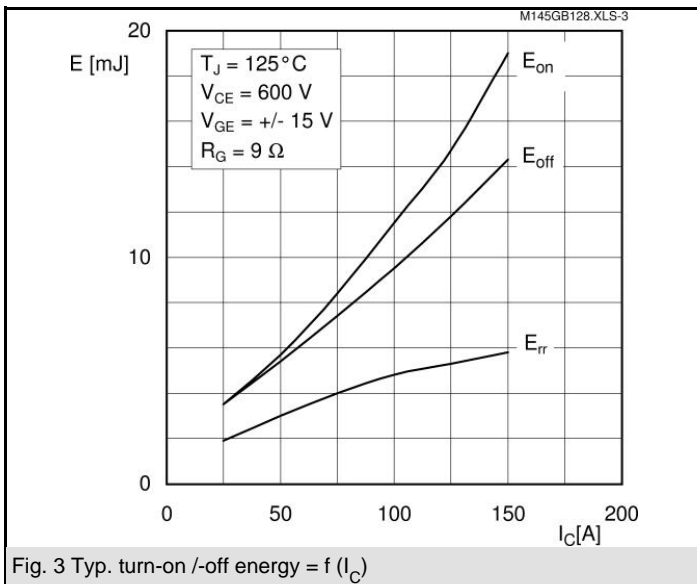
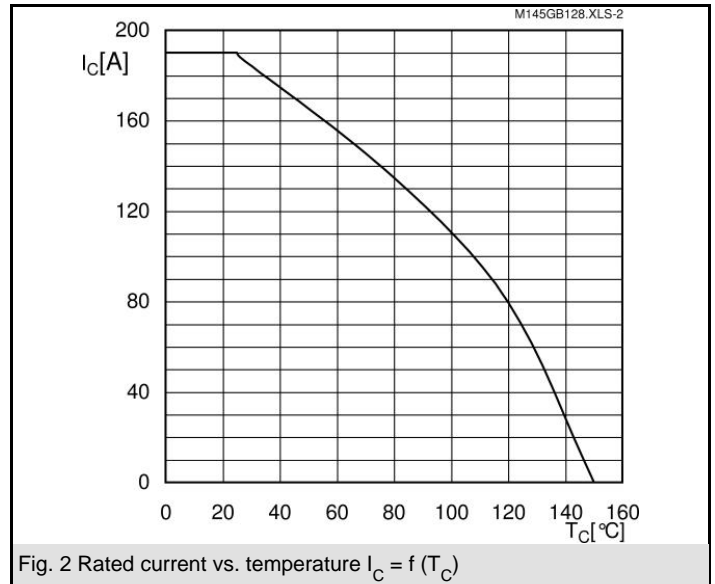
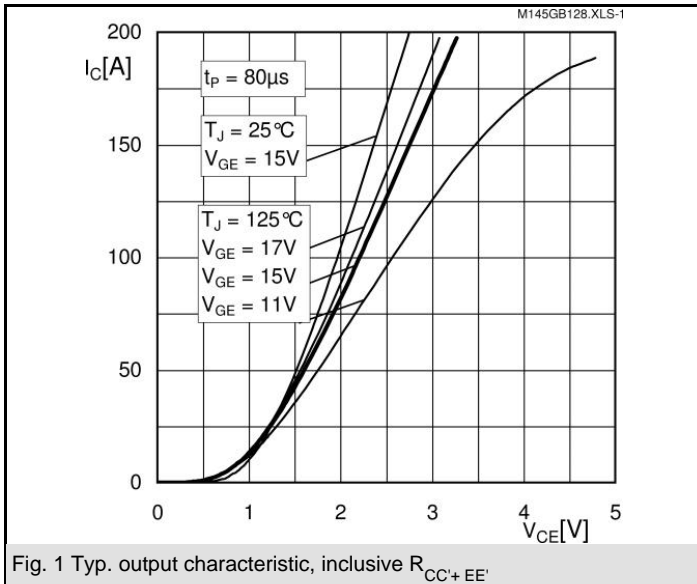

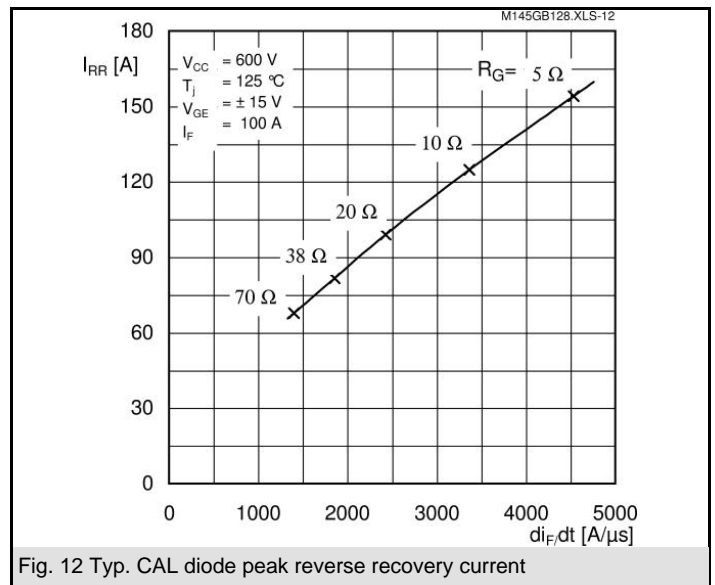
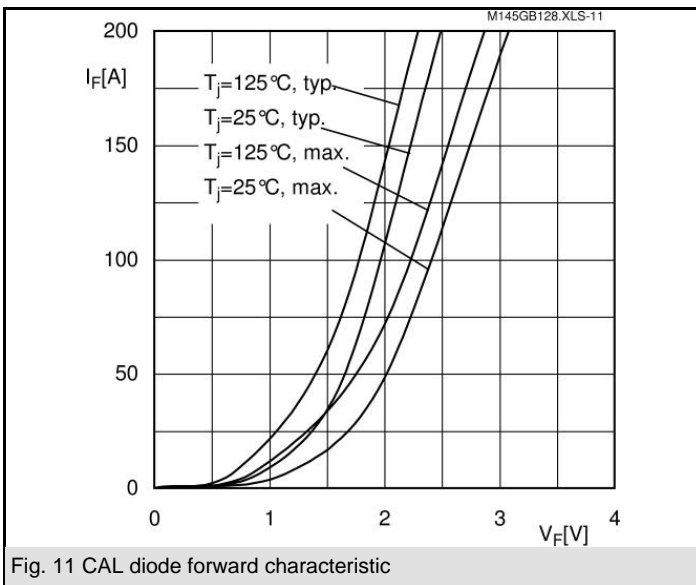
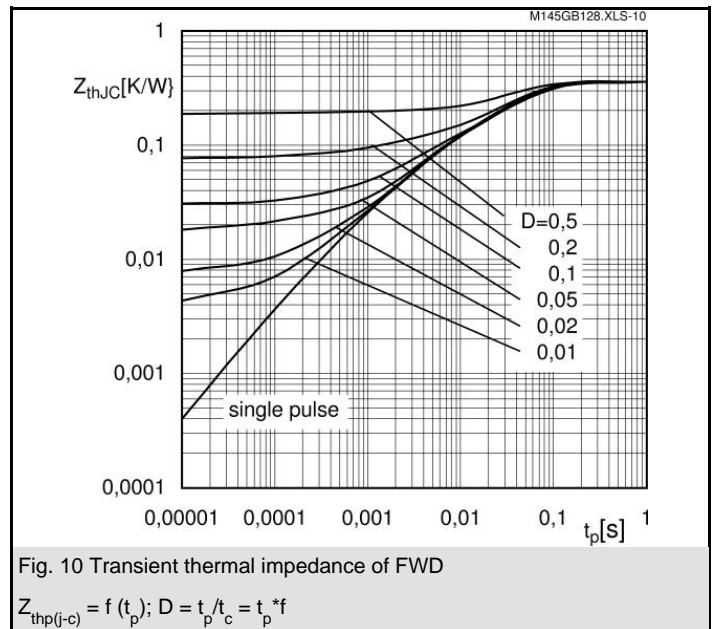
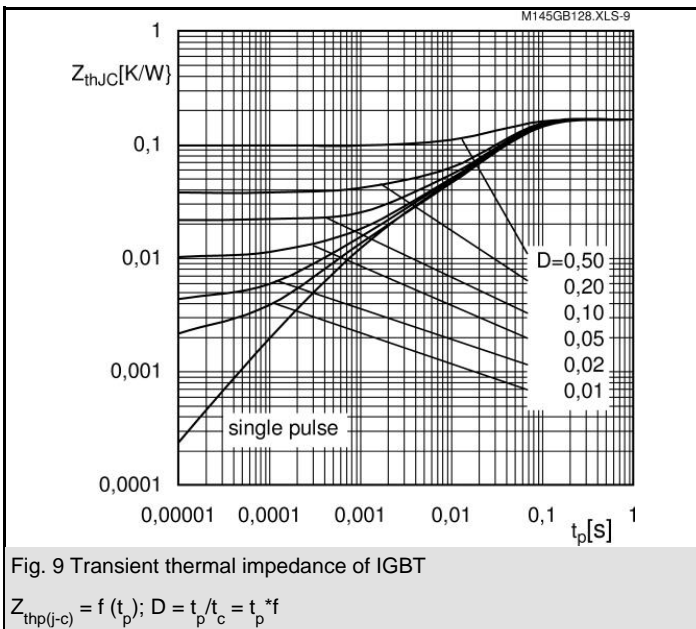
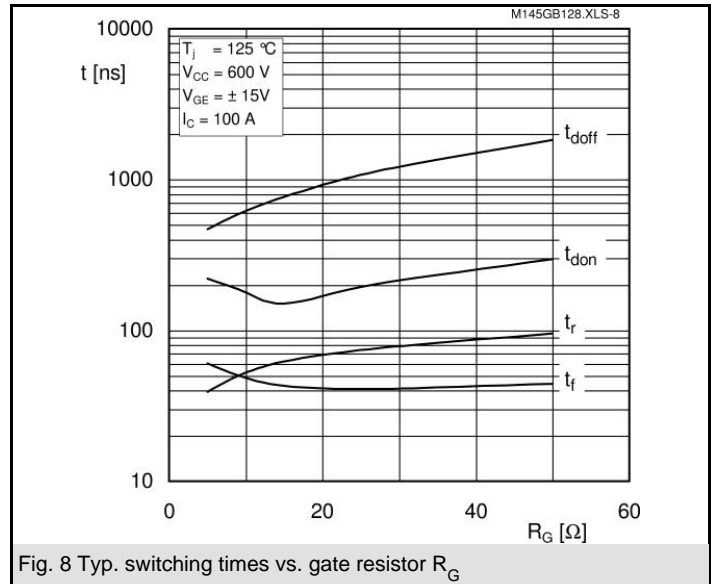
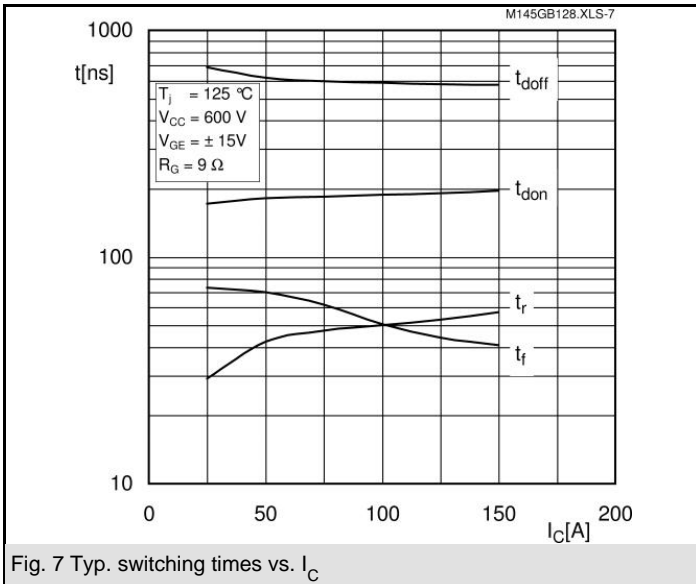

SKM 145GB128DN

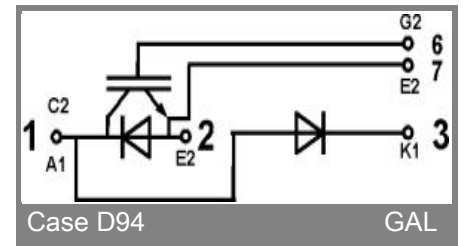
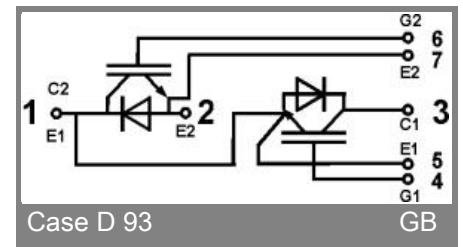
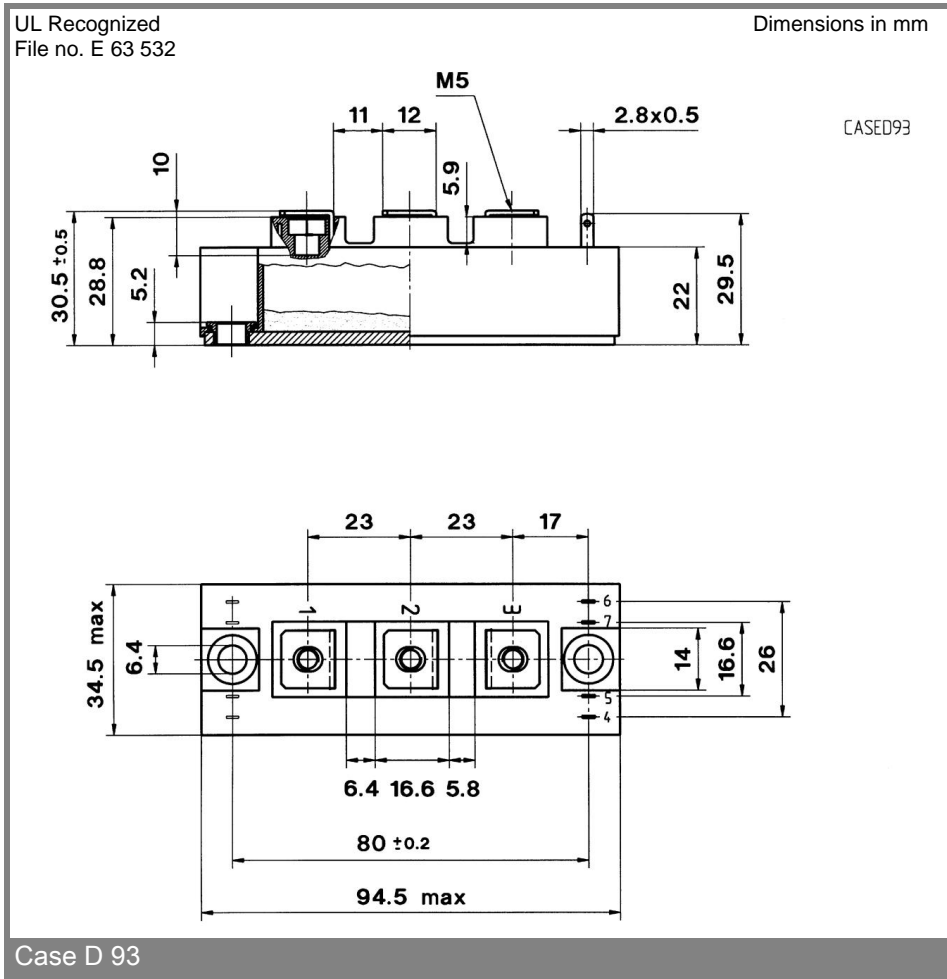
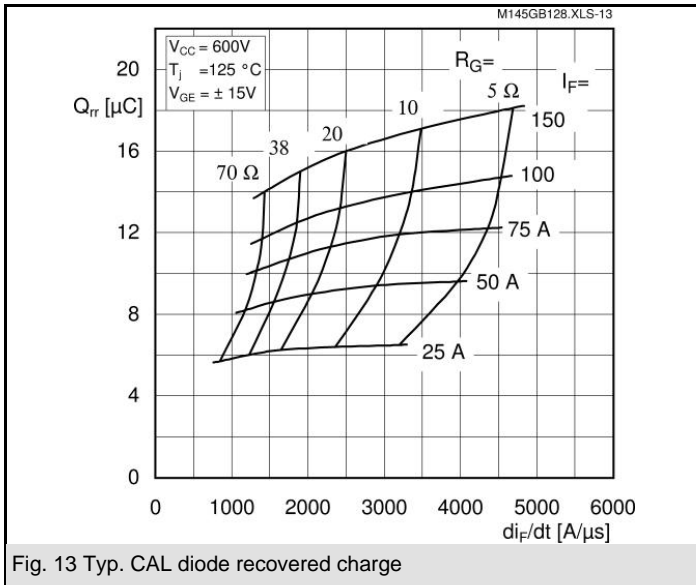

This is an electrostatic discharge sensitive device (ESDS), international standard IEC 60747-1, Chapter IX.

This technical information specifies semiconductor devices but promises no characteristics. No warranty or guarantee expressed or implied is made regarding delivery, performance or suitability.