

SKM 100GB176DN

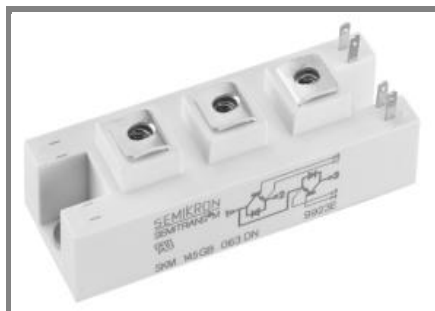

SEMITRANS™ 2N

Trench IGBT Modules

SKM 100GB176DN

Preliminary Data

Features

- Homogeneous Si
- Trench = Trenchgate technology
- V_{CEsat} with positive temperature coefficient
- High short circuit capability, self limiting to $6 \times I_C$

Typical Applications

- AC inverter drives mains 575 - 750 V AC
- Public transport (auxiliary syst.)

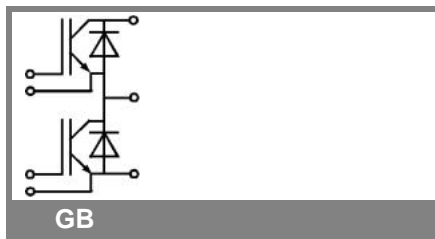

Absolute Maximum Ratings		$T_c = 25\text{ }^\circ\text{C}$, unless otherwise specified	
Symbol	Conditions	Values	Units
IGBT			
V_{CES}		1700	V
I_C	$T_c = 25\text{ (80) }^\circ\text{C}$	125 (90)	A
I_{CRM}	$t_p = 1\text{ ms}$	150	A
V_{GES}		± 20	V
T_{vj} (T_{stg})	$T_{OPERATION} \leq T_{stg}$	- 40...+ 150 (125)	$^\circ\text{C}$
V_{isol}	AC, 1 min.	4000	V
Inverse diode			
I_F	$T_c = 25\text{ (80) }^\circ\text{C}$	100 (70)	A
I_{FRM}	$t_p = 1\text{ ms}$	150	A
I_{FSM}	$t_p = 10\text{ ms; sin.; } T_j = 150\text{ }^\circ\text{C}$	720	A

Characteristics		$T_c = 25\text{ }^\circ\text{C}$, unless otherwise specified			
Symbol	Conditions	min.	typ.	max.	Units
IGBT					
$V_{GE(th)}$	$V_{GE} = V_{CE}; I_C = 3\text{ mA}$	5,2	5,8	6,4	V
I_{CES}	$V_{GE} = 0; V_{CE} = V_{CES}; T_j = 25\text{ (125) }^\circ\text{C}$		0,1	0,3	mA
$V_{CE(TO)}$	$T_j = 25\text{ (125) }^\circ\text{C}$		1 (0,9)	1,2 (1,1)	V
r_{CE}	$V_{GE} = 15\text{ V}; T_j = 25\text{ (125) }^\circ\text{C}$		13 (20)	17	m Ω
$V_{CE(sat)}$	$I_C = 75\text{ A}; V_{GE} = 15\text{ V}$, chip level		2 (2,4)	2,45	V
C_{ies}	under following conditions		6		nF
C_{oes}	$V_{GE} = 0; V_{CE} = 25\text{ V}; f = 1\text{ MHz}$		0,6		nF
C_{res}			0,4		nF
L_{CE}				25	nH
$R_{CC'+EE'}$	res., terminal-chip $T_c = 25\text{ (125) }^\circ\text{C}$		0,75 (1)		m Ω
$t_{d(on)}$	$V_{CC} = 1200\text{ V}; I_C = 75\text{ A}$		300		ns
t_r	$R_{Gon} = R_{Goff} = 15\text{ }^\circ\Omega; T_j = 125\text{ }^\circ\text{C}$		45		ns
$t_{d(off)}$	$V_{GE} \pm 15\text{ V}$		830		ns
t_f			140		ns
$E_{on} (E_{off})$			46 (28)		mJ
Inverse diode					
$V_F = V_{EC}$	$I_F = 75\text{ A}; V_{GE} = 0\text{ V}; T_j = 25\text{ (125) }^\circ\text{C}$		1,6 (1,6)	1,9 (1,9)	V
$V_{(TO)}$	$T_j = 25\text{ (125) }^\circ\text{C}$		1,1 (0,9)	1,3 (1,1)	V
r_T	$T_j = 25\text{ (125) }^\circ\text{C}$		6,7 (9,3)	8 (11)	m Ω
I_{RRM}	$I_F = 75\text{ A}; T_j = 125\text{ () }^\circ\text{C}$		95		A
Q_{rr}	$di/dt = 1760\text{ A}/\mu\text{s}$		27		μC
E_{rr}	$V_{GE} = 0\text{ V}$		17		mJ
Thermal characteristics					
$R_{th(j-c)}$	per IGBT			0,24	K/W
$R_{th(j-c)D}$	per Inverse Diode			0,45	K/W
$R_{th(c-s)}$	per module			0,05	K/W
Mechanical data					
M_s	to heatsink M6	3		5	Nm
M_t	to terminals M5	2,5		5	Nm
w				160	g

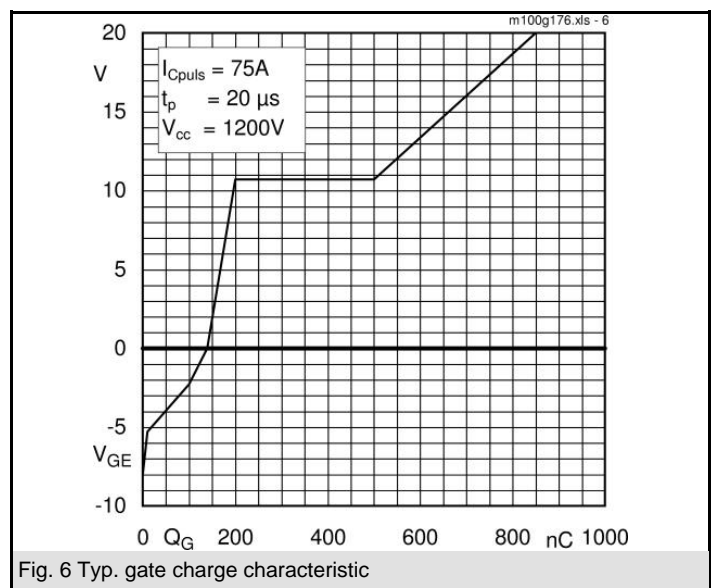
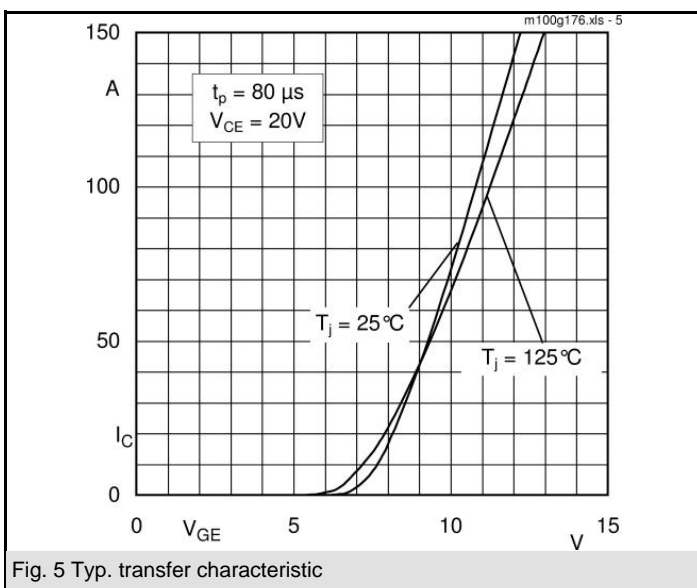
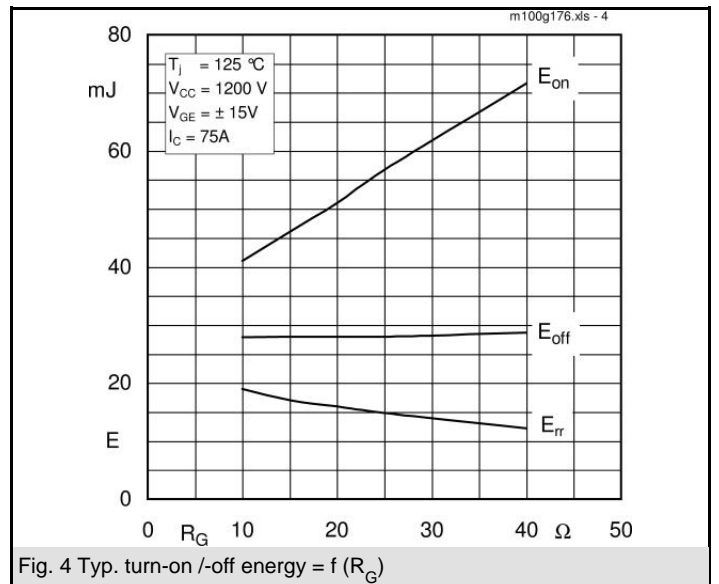
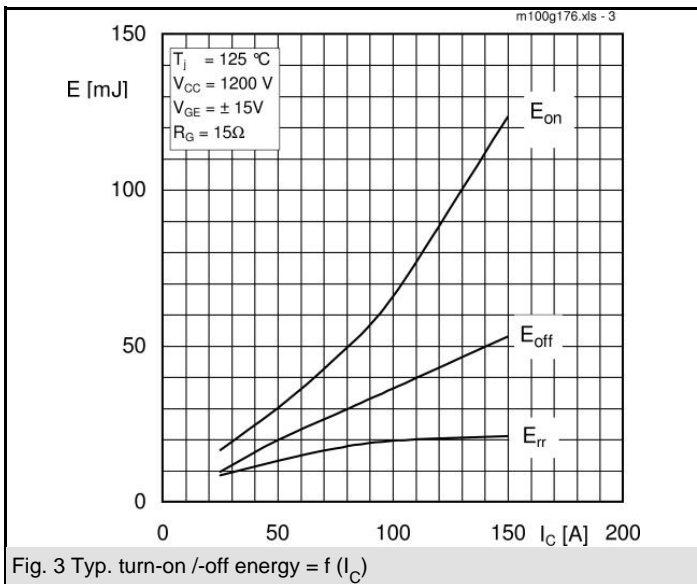
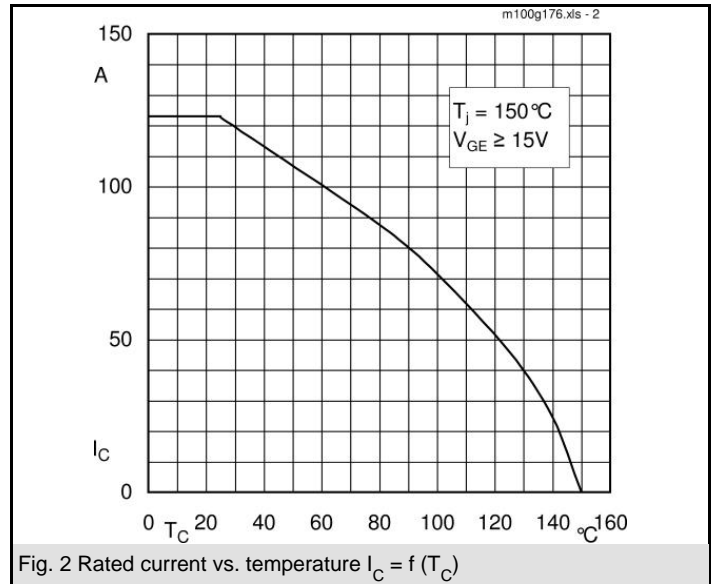
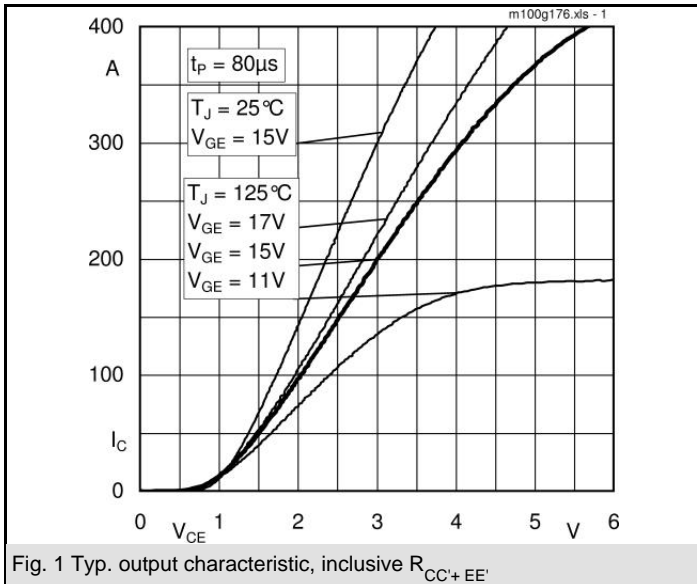

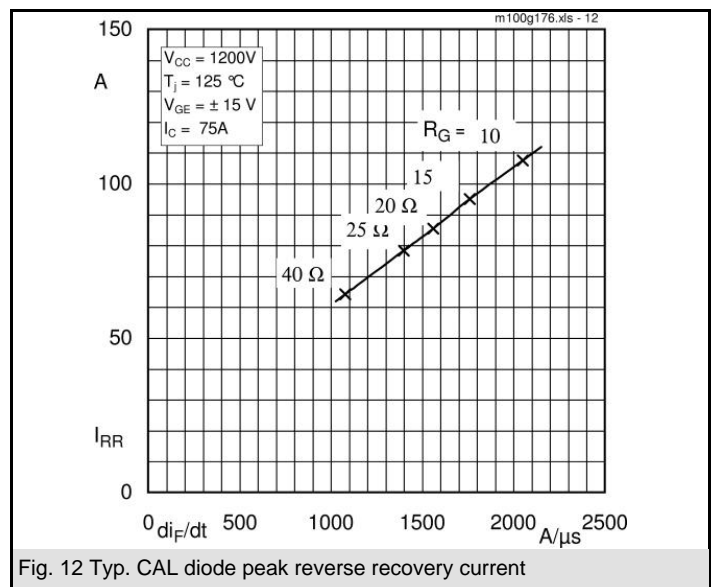
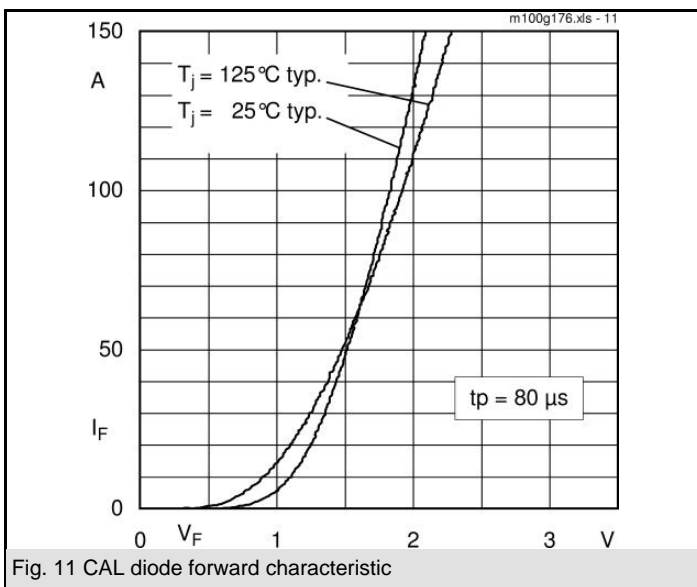
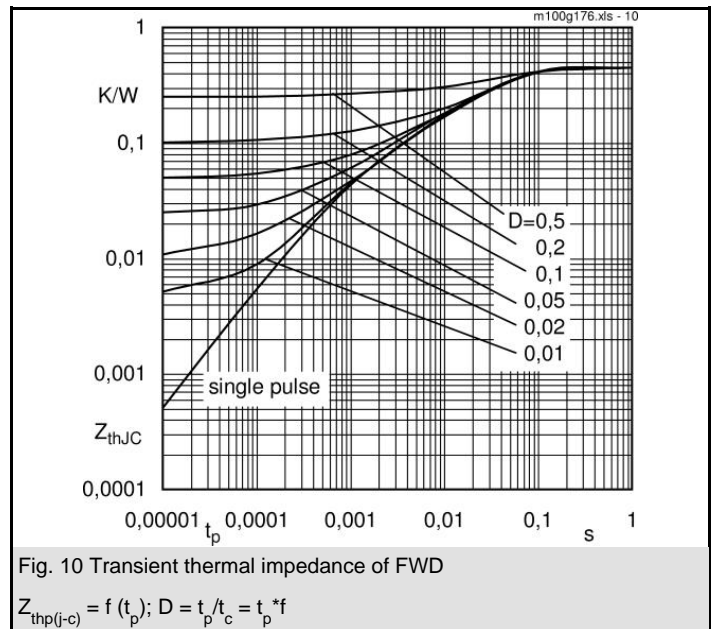
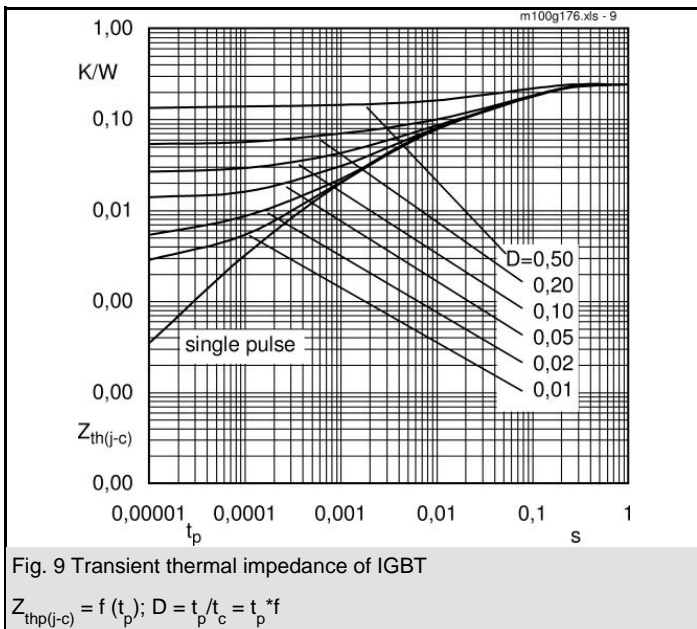
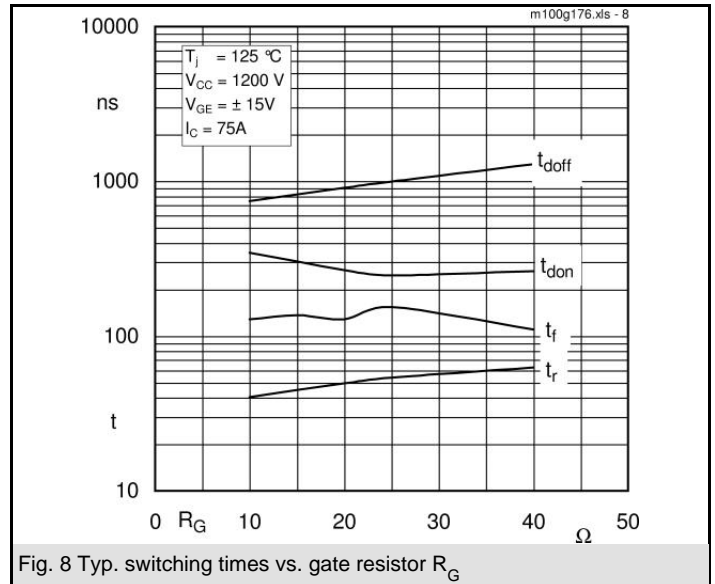
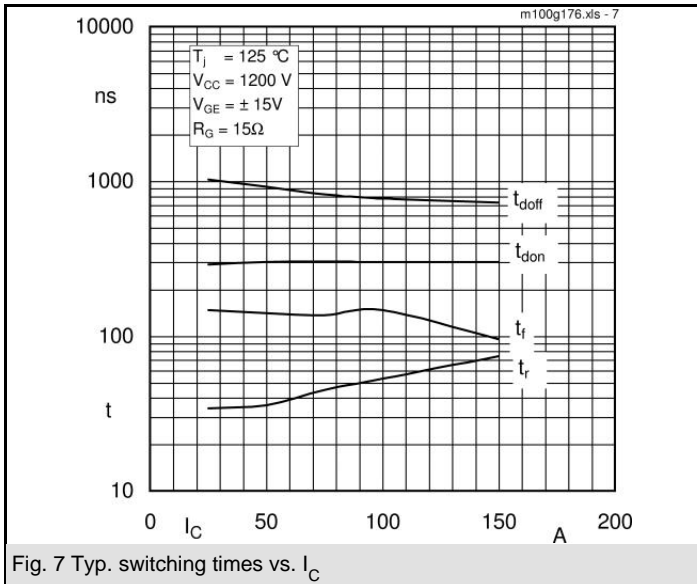

SKM 100GB176DN

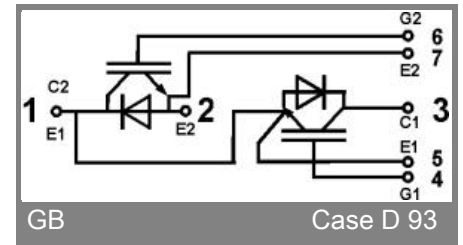
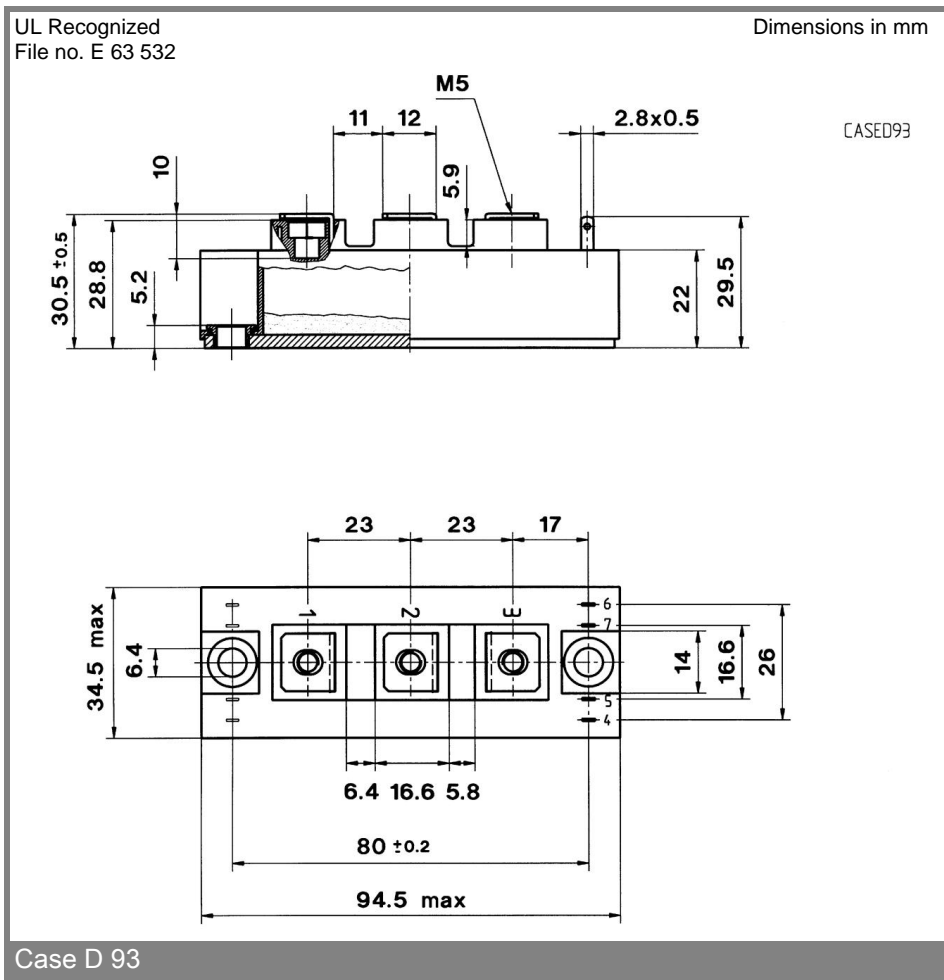
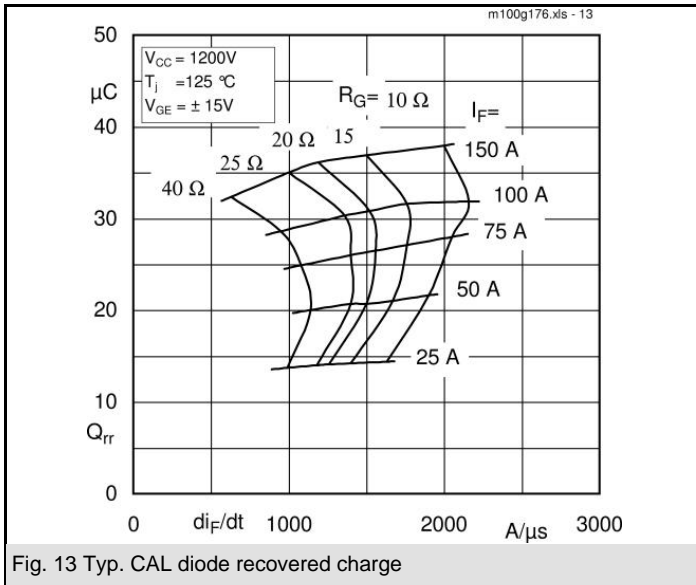

This is an electrostatic discharge sensitive device (ESDS), international standard IEC 60747-1, Chapter IX.

This technical information specifies semiconductor devices but promises no characteristics. No warranty or guarantee expressed or implied is made regarding delivery, performance or suitability.