

# SKKT 27, SKKT 27B, SKKH 27



**SEMIPACK® 1**

## Thyristor / Diode Modules

**SKKT 27**

**SKKT 27B**

**SKKH 27**

### Features

- Heat transfer through aluminium oxide ceramic isolated metal baseplate
- Hard soldered joints for high reliability
- UL recognized, file no. E 63 532

### Typical Applications

- DC motor control (e. g. for machine tools)
- AC motor soft starters
- Temperature control (e. g. for ovens, chemical processes)
- Professional light dimming (studios, theaters)

1) See the assembly instructions

$V_{RSM}$ V	$V_{RRM}, V_{DRM}$ V	$I_{TRMS} = 50$ A (maximum value for continuous operation) $I_{TAV} = 27$ A (sin. 180; $T_c = 82$ °C)		
900	800	SKKT 27/08E	SKKT 27B08E	SKKH 27/08E
1300	1200	SKKT 27/12E	SKKT 27B12E	SKKH 27/12E
1500	1400	SKKT 27/14E	SKKT 27B14E	SKKH 27/14E
1700	1600	SKKT 27/16E	SKKT 27B16E	SKKH 27/16E
1900	1800			SKKH 27/18E

Symbol	Conditions	Values	Units
$I_{TAV}$	sin. 180; $T_c = 85$ (100) °C;	25 (18)	A
$I_D$	P3/180; $T_a = 45$ °C; B2 / B6	38 / 50	A
	P3/180F; $T_a = 35$ °C; B2 / B6	60 / 77	A
$I_{RMS}$	P3/180; $T_a = 45$ °C; W1 / W3	52 / 3 x 37	A
$I_{TSM}$	$T_{vj} = 25$ °C; 10 ms	550	A
	$T_{vj} = 125$ °C; 10 ms	480	A
$i^2t$	$T_{vj} = 25$ °C; 8,3 ... 10 ms	1500	A <sup>2</sup> s
	$T_{vj} = 125$ °C; 8,3 ... 10 ms	1150	A <sup>2</sup> s
$V_T$	$T_{vj} = 25$ °C; $I_T = 75$ A	max. 1,8	V
$V_{T(TO)}$	$T_{vj} = 125$ °C	max. 0,9	V
$r_T$	$T_{vj} = 125$ °C	max. 12	mΩ
$I_{DD}; I_{RD}$	$T_{vj} = 125$ °C; $V_{RD} = V_{RRM}; V_{DD} = V_{DRM}$	max. 10	mA
$t_{gd}$	$T_{vj} = 25$ °C; $I_G = 1$ A; $di_G/dt = 1$ A/μs	1	μs
$t_{gr}$	$V_D = 0,67 * V_{DRM}$	1	μs
$(di/dt)_{cr}$	$T_{vj} = 125$ °C	max. 150	A/μs
$(dv/dt)_{cr}$	$T_{vj} = 125$ °C	max. 1000	V/μs
$t_q$	$T_{vj} = 125$ °C	80	μs
$I_H$	$T_{vj} = 25$ °C; typ. / max.	100 / 200	mA
$I_L$	$T_{vj} = 25$ °C; $R_G = 33$ Ω; typ. / max.	250 / 400	mA
$V_{GT}$	$T_{vj} = 25$ °C; d.c.	min. 3	V
$I_{GT}$	$T_{vj} = 25$ °C; d.c.	min. 150	mA
$V_{GD}$	$T_{vj} = 125$ °C; d.c.	max. 0,25	V
$I_{GD}$	$T_{vj} = 125$ °C; d.c.	max. 5	mA
$R_{th(j-c)}$	cont.; per thyristor / per module	0,9 / 0,45	K/W
$R_{th(j-c)}$	sin. 180; per thyristor / per module	0,95 / 0,48	K/W
$R_{th(j-c)}$	rec. 120; per thyristor / per module	1 / 0,5	K/W
$R_{th(c-s)}$	per thyristor / per module	0,2 / 0,1	K/W
$T_{vj}$		- 40 ... + 125	°C
$T_{stg}$		- 40 ... + 125	°C
$V_{isol}$	a. c. 50 Hz; r.m.s.; 1 s / 1 min.	3600 / 3000	V~
$M_s$	to heatsink	5 ± 15 % <sup>1)</sup>	Nm
$M_t$	to terminals	3 ± 15 %	Nm
$a$		5 * 9,81	m/s <sup>2</sup>
$m$	approx.	95	g
Case	SKKT	A 46	
	SKKT ...B	A 48	
	SKKH	A 47	



**SKKT**

**SKKH**

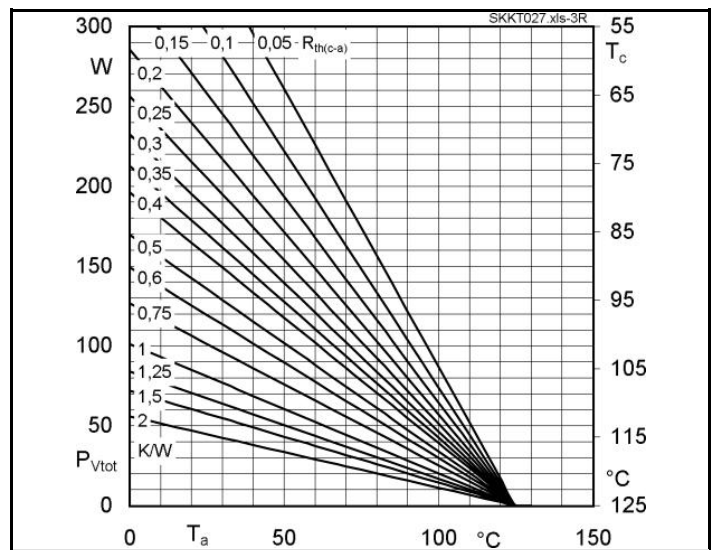
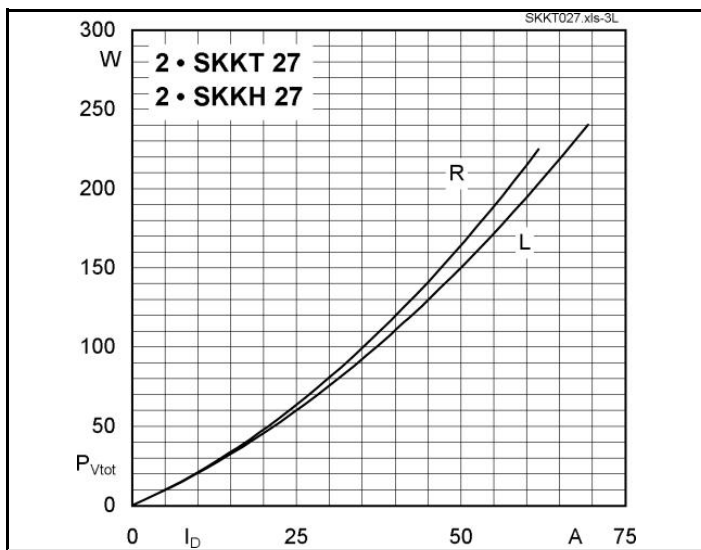
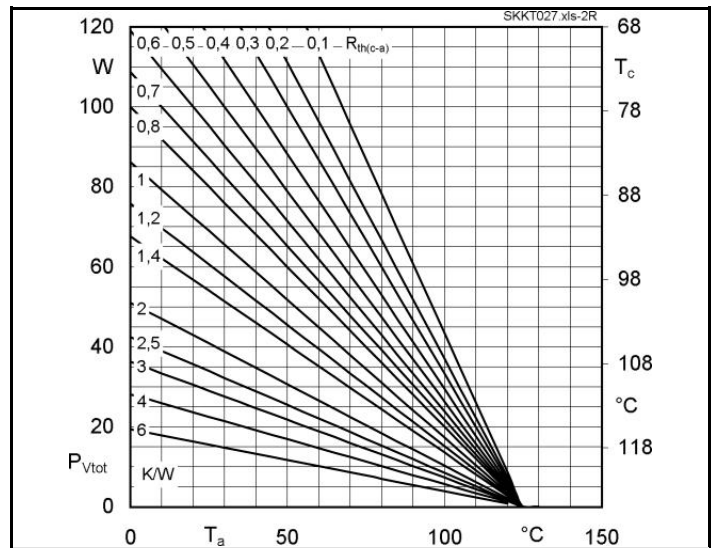
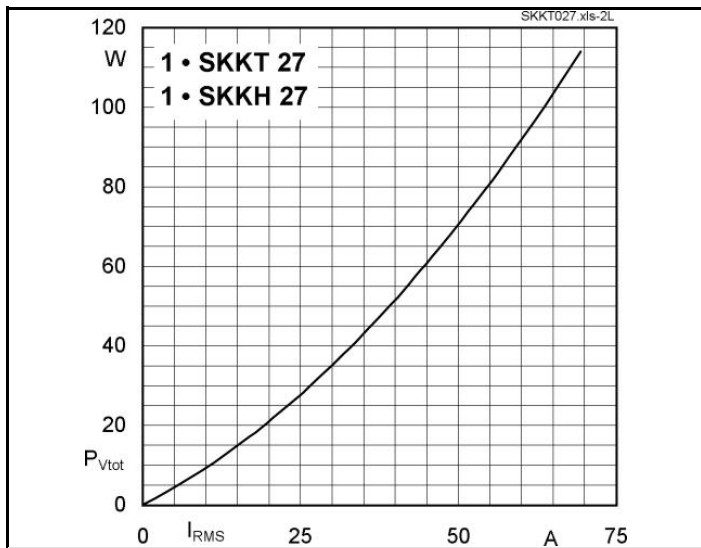
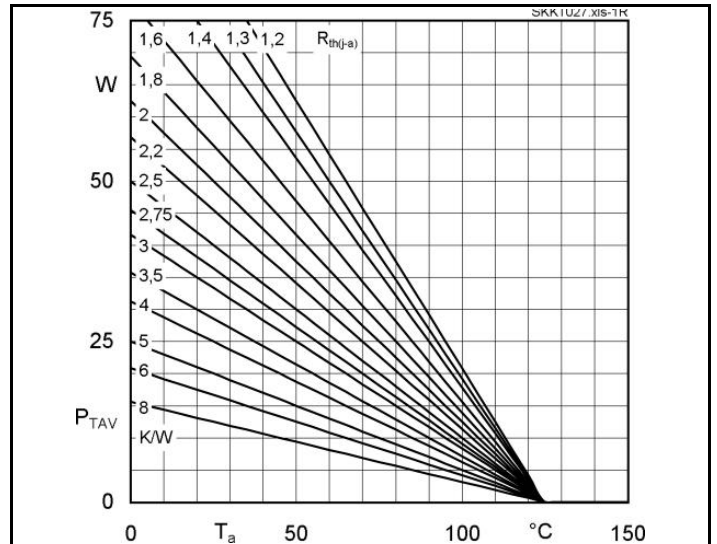
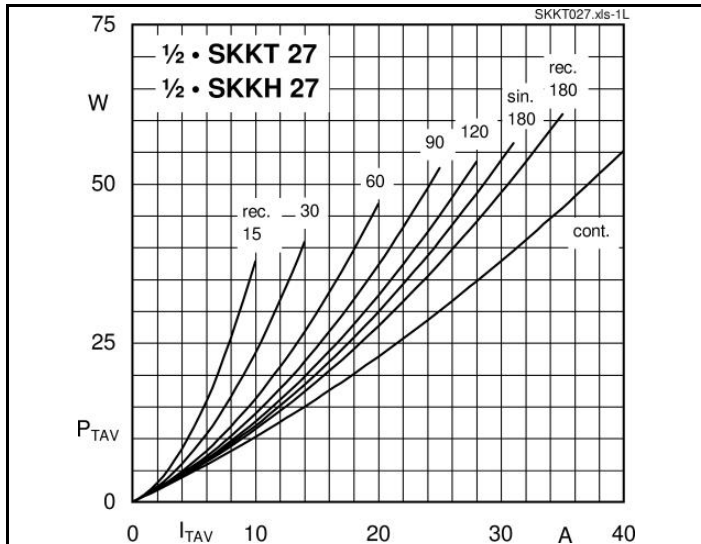

# SKKT 27, SKKT 27B, SKKH 27

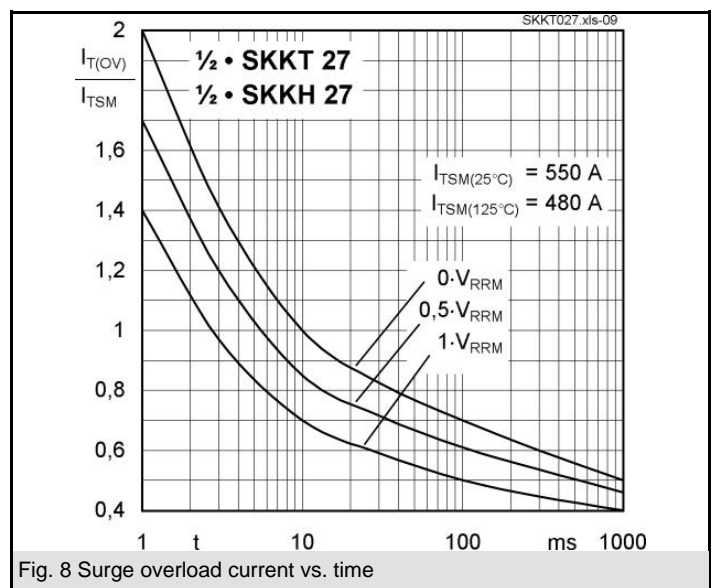
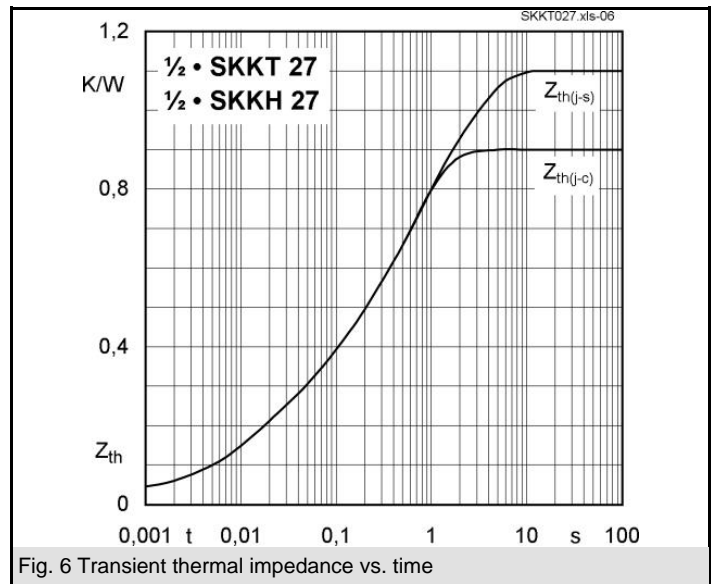
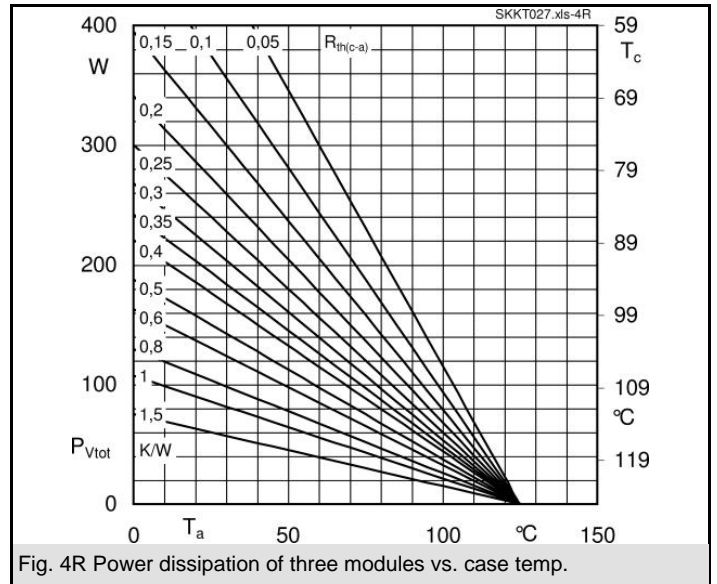

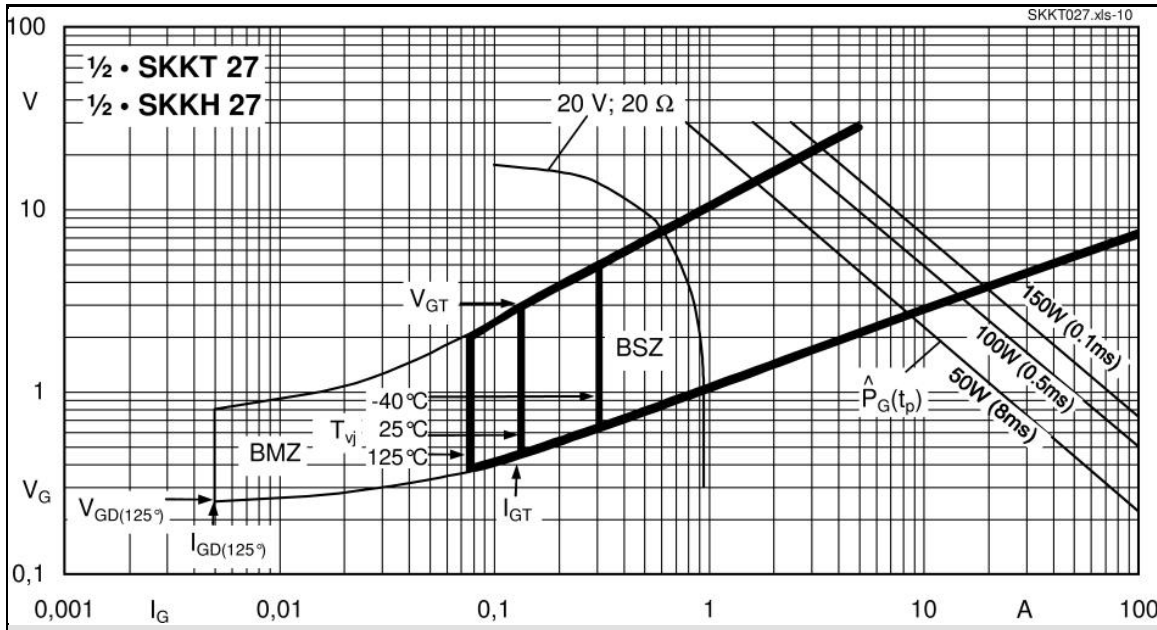
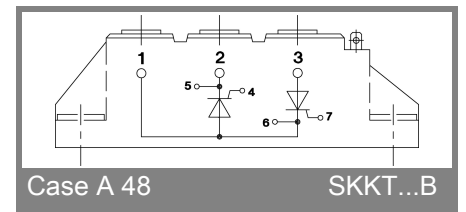
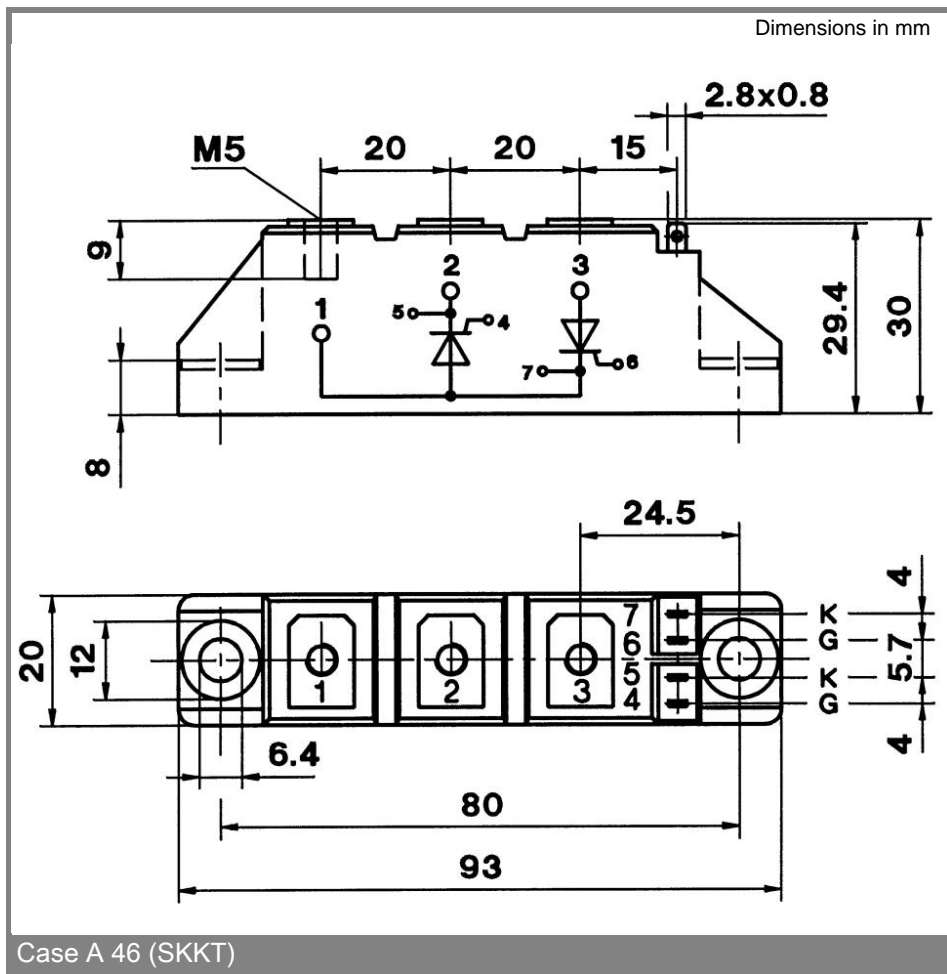

Fig. 9 Gate trigger characteristics



This technical information specifies semiconductor devices but promises no characteristics. No warranty or guarantee expressed or implied is made regarding delivery, performance or suitability.