

**SEMIPACK® 6**

## Rectifier Diode Modules

### SKKE 1200/22 H4

#### Features

- Precise metal pressure contacts for high reliability
- UL recognized, file no. E 63 532

#### Typical Applications\*

- Rectifiers

Absolute Maximum Ratings				
Symbol	Conditions		Values	Unit
<b>Rectifier Diode</b>				
$I_{FAV}$	sin. 180°	$T_c = 85\text{ °C}$	1376	A
		$T_c = 100\text{ °C}$	1180	A
$I_{FSM}$	10 ms	$T_j = 25\text{ °C}$	45000	A
		$T_j = 160\text{ °C}$	40000	A
$i^2t$	10 ms	$T_j = 25\text{ °C}$	10125000	A <sup>2</sup> s
		$T_j = 160\text{ °C}$	8000000	A <sup>2</sup> s
$V_{RSM}$			2200	V
$V_{RRM}$			2200	V
$T_j$			-40 ... 160	°C
<b>Module</b>				
$T_{stg}$			-40 ... 125	°C
$V_{isol}$	a.c.; 50 Hz; r.m.s.	1 min	4000	V
		1 s	4800	V

Characteristics						
Symbol	Conditions		min.	typ.	max.	Unit
<b>Diode</b>						
$V_F$	$T_j = 25\text{ °C}, I_F = 3000\text{ A}$				1.40	V
$V_{(TO)}$	$T_j = 160\text{ °C}$				0.72	V
$r_T$	$T_j = 160\text{ °C}$				0.19	mΩ
$I_{RD}$	$T_j = 160\text{ °C}, V_{RD} = V_{RRM}$				60	mA
$R_{th(j-c)}$	cont.	per chip			0.0385	K/W
		per module			0.0385	K/W
$R_{th(j-c)}$	sin. 180°	per chip			0.04	K/W
		per module			0.04	K/W
<b>Module</b>						
$R_{th(c-s)}$	chip				0.01	K/W
	module				0.01	K/W
$M_s$	to heatsink M6		5.1		6.9	Nm
$M_t$	to terminal M12		15.3		20.7	Nm
$a$					5 * 9,81	m/s <sup>2</sup>
$w$				2150		g

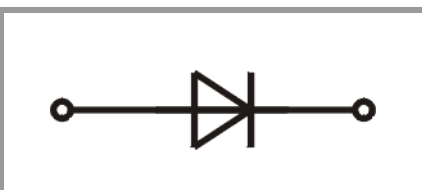

**SKKE**

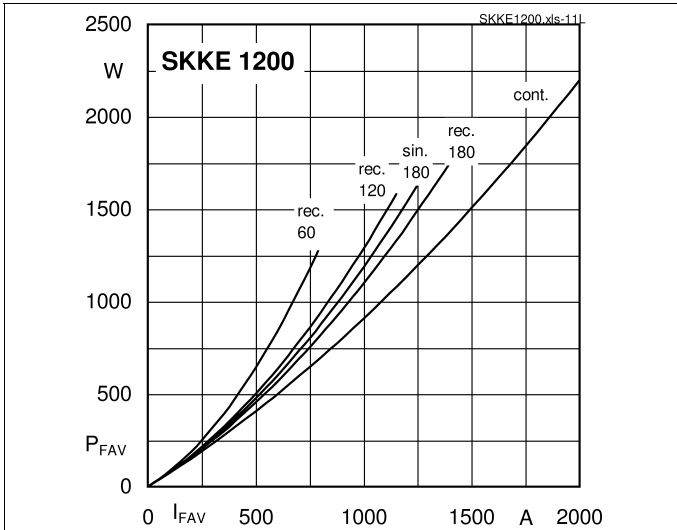

Fig. 11L: Power dissipation per diode vs. forward current

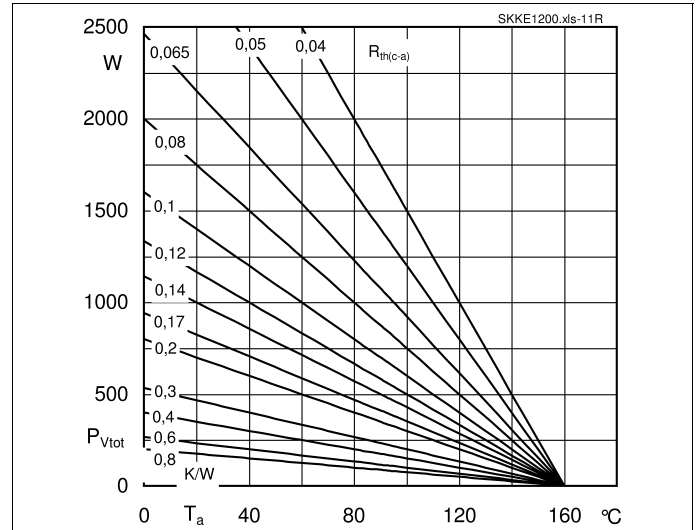

Fig. 11R: Power dissipation per diode vs. ambient temperature

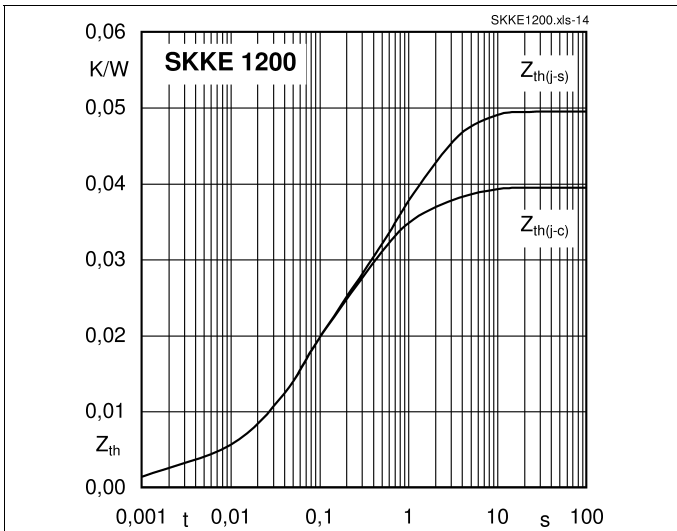

Fig. 14: Transient thermal impedance vs. time

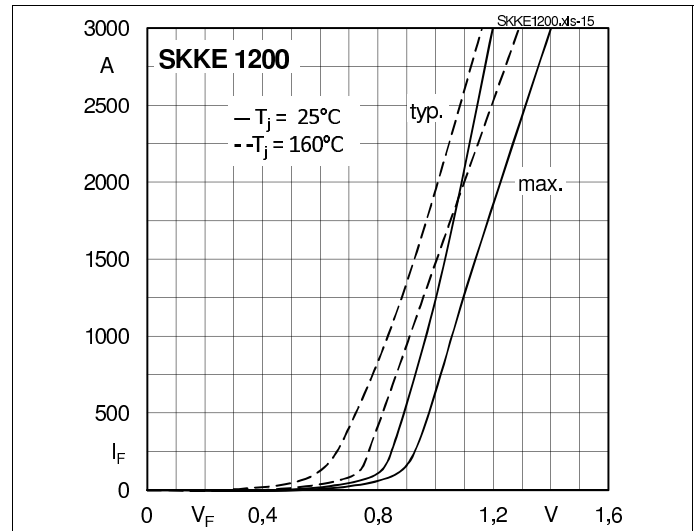

Fig. 15: Forward characteristics

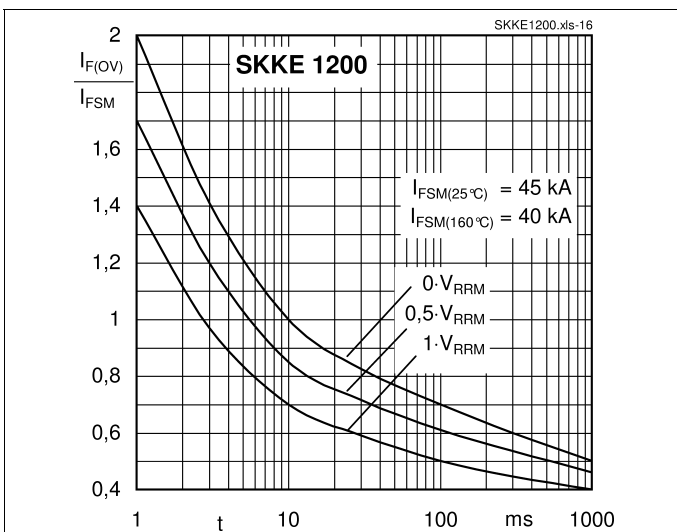
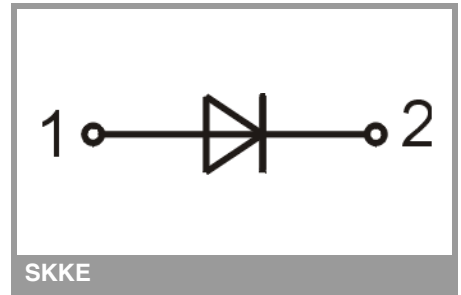
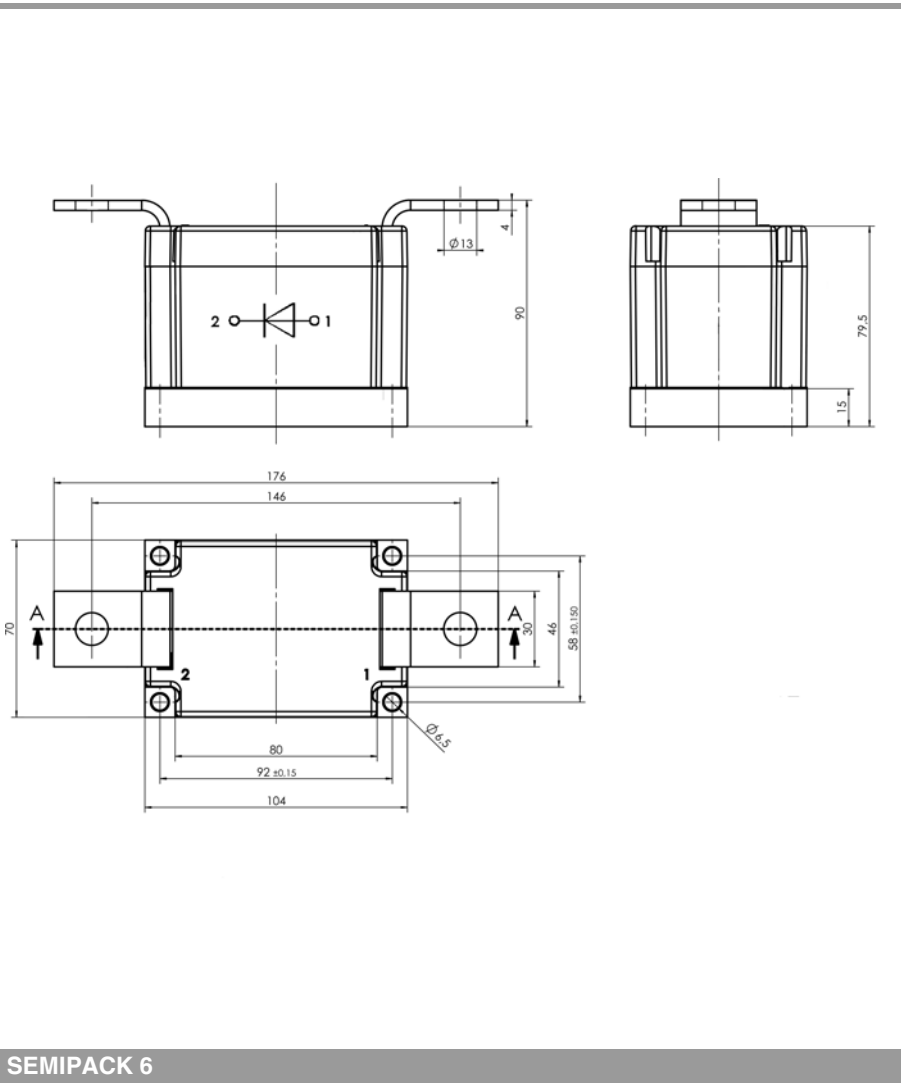

Fig. 16: Surge overload current vs. time

# SKKE 1200/22 H4



This is an electrostatic discharge sensitive device (ESDS), international standard IEC 60747-1, Chapter IX

\* The specifications of our components may not be considered as an assurance of component characteristics. Components have to be tested for the respective application. Adjustments may be necessary. The use of SEMIKRON products in life support appliances and systems is subject to prior specification and written approval by SEMIKRON. We therefore strongly recommend prior consultation of our staff.