



**SEMIPACK® 5**

## Rectifier Diode Modules

### SKKD 700

#### Features

- Heat transfer through aluminium nitride ceramic isolated metal baseplate
- Precise metal pressure contacts for high reliability
- UL recognized, file no. E 63 532

#### Typical Applications

- Uncontrolled rectifiers for AC/AC converters
- Line rectifiers for transistorized AC motor controllers

1) The screws must be lubricated

$V_{RSM}$ V	$V_{RRM}$ V	$I_{FRMS} = 1100$ A (maximum value for continuous operation) $I_{FAV} = 700$ A (sin. 180; $T_c = 100$ °C)	
900	800	SKKD 700/08	
1300	1200	SKKD 700/12	
1500	1400	SKKD 700/14	
1700	1600	SKKD 700/16	
1900	1800	SKKD 700/18	
2100	2000	SKKD 700/20 H4	
2300	2200	SKKD 700/22 H4	

Symbol	Conditions	Values	Units
$I_{FAV}$	sin. 180; $T_c = 100$ °C	700	A
$I_{FSM}$	$T_{vj} = 25$ °C; 10 ms	25000	A
	$T_{vj} = 125$ °C; 10 ms	22000	A
$i^2t$	$T_{vj} = 25$ °C; 8,3 ... 10 ms	3125000	A <sup>2</sup> s
	$T_{vj} = 125$ °C; 8,3 ... 10 ms	2420000	A <sup>2</sup> s
$V_F$	$T_{vj} = 25$ °C; $I_F = 2000$ A	max. 1,3	V
$V_{(TO)}$	$T_{vj} = 150$ °C	max. 0,75	V
$r_T$	$T_{vj} = 150$ °C	max. 0,2	mΩ
$I_{RD}$	$T_{vj} = 150$ °C; $V_{RD} = V_{RRM}$	max. 20	mA
$R_{th(j-c)}$	cont.; per diode / per module	0,062 / 0,031	K/W
	sin. 180; per diode / per module	0,065 / 0,0325	K/W
	rec. 120; per diode / per module	0,07 / 0,035	K/W
$R_{th(c-s)}$	per diode / per module	0,02 / 0,01	K/W
$T_{vj}$		- 40 ... + 150	°C
$T_{stg}$		- 40 ... + 130	°C
$V_{isol}$	a. c. 50 Hz; r.m.s.; 1 s / 1 min.	3600 / 3000	V~
$V_{isol}$	a. c. 50 Hz; r.m.s.; 1 s / 1 min. for SKKD ...H4	4800 / 4000	V~
$M_s$	to heatsink	5 ± 15 %	Nm
$M_t$	to terminals	12 ± 15 % <sup>1)</sup>	Nm
a		5 * 9,81	m/s <sup>2</sup>
m	approx.	1420	g
Case		A 75a	

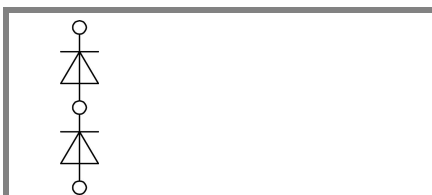

**SKKD**

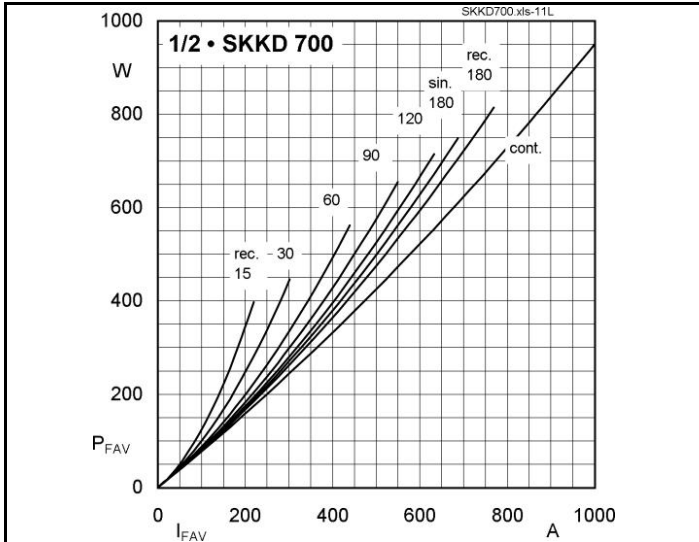

Fig. 11L Power dissipation per diode vs. forward current

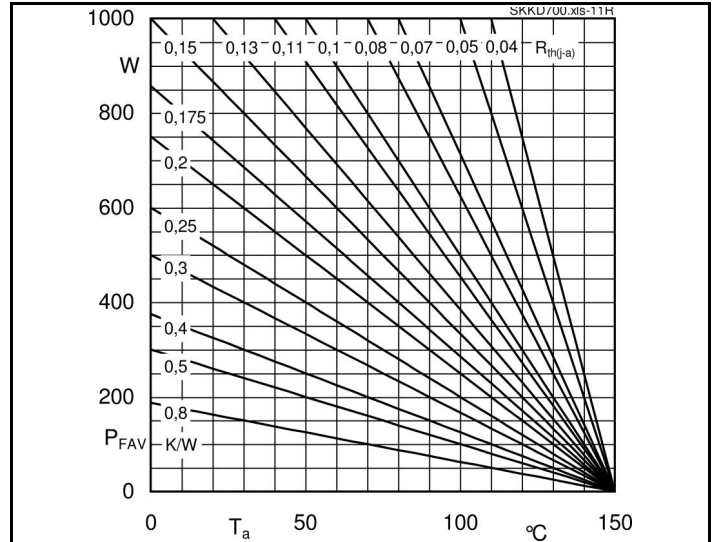

Fig. 11R Power dissipation per diode vs. ambient temperature

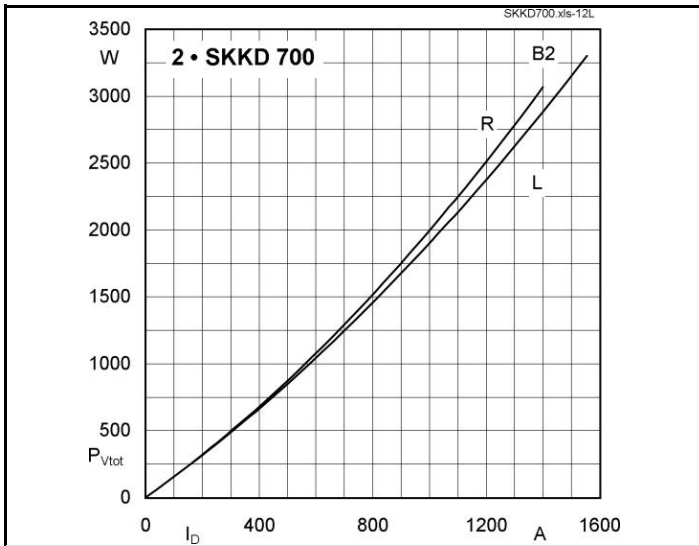

Fig. 12L Power dissipation of two modules vs. direct current

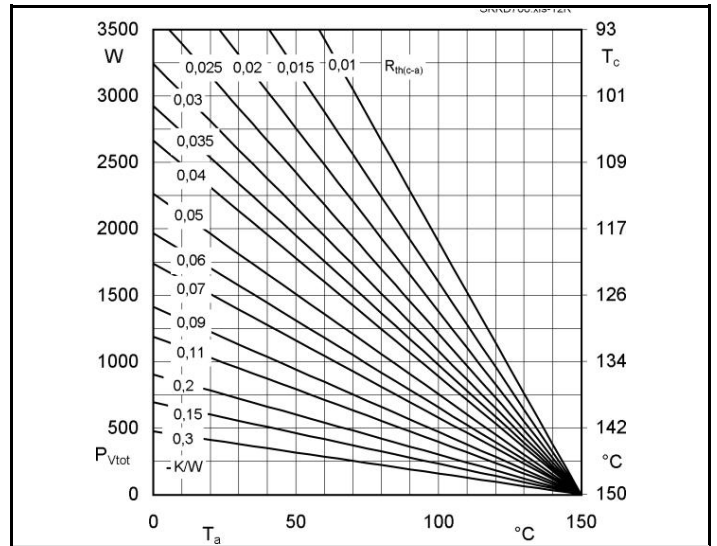

Fig. 12R Power dissipation of two modules vs. case temperature

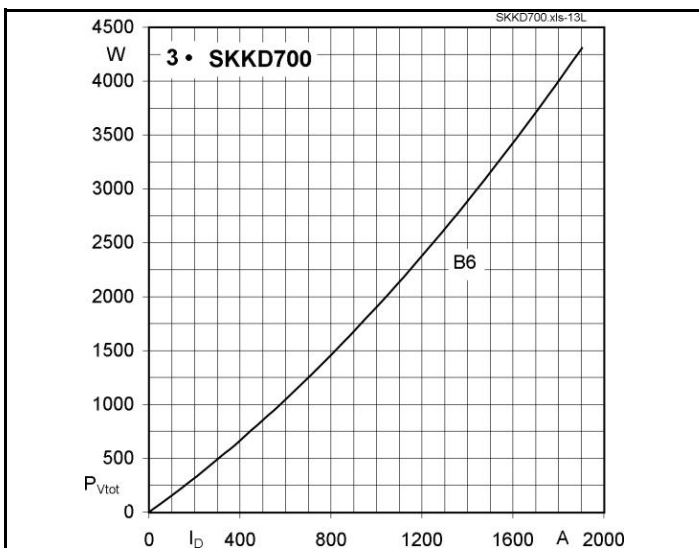

Fig. 13L Power dissipation of three modules vs. direct current

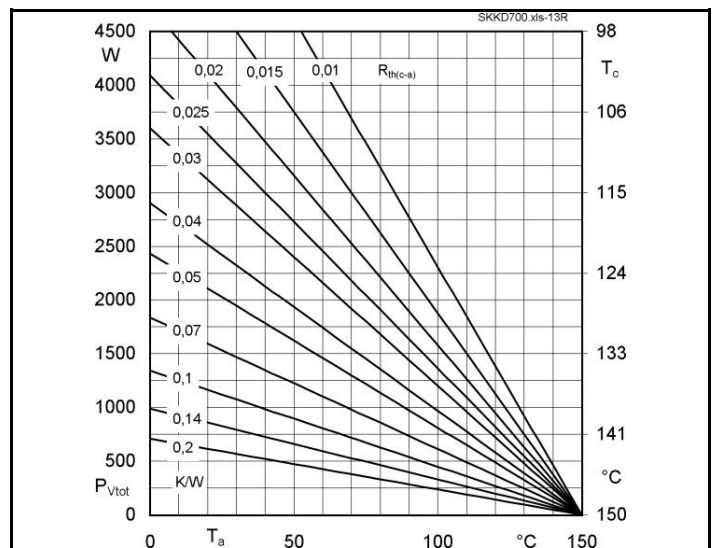

Fig. 13R Power dissipation of three modules vs. case temperature

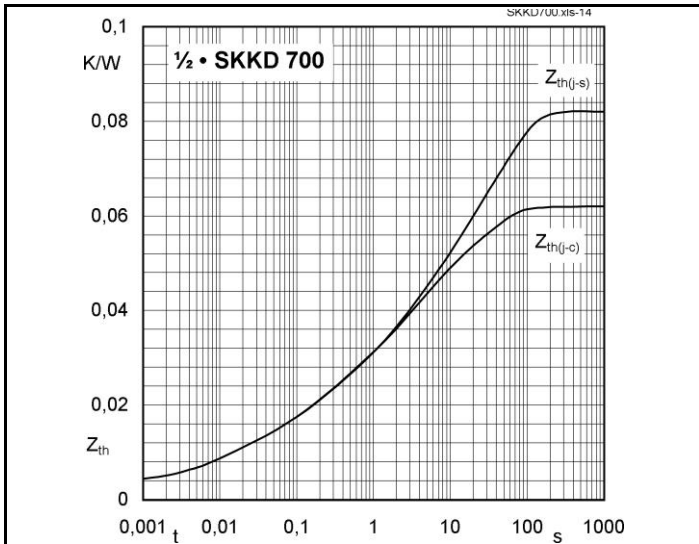

Fig. 14 Transient thermal impedance vs. time

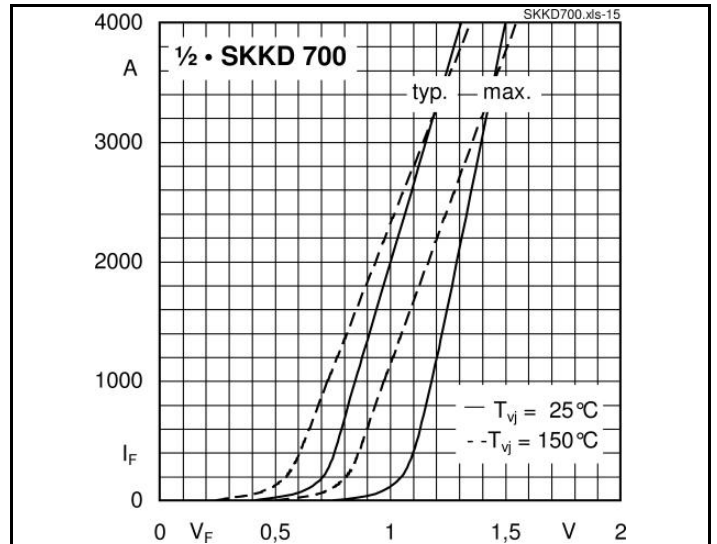

Fig. 15 Forward characteristics

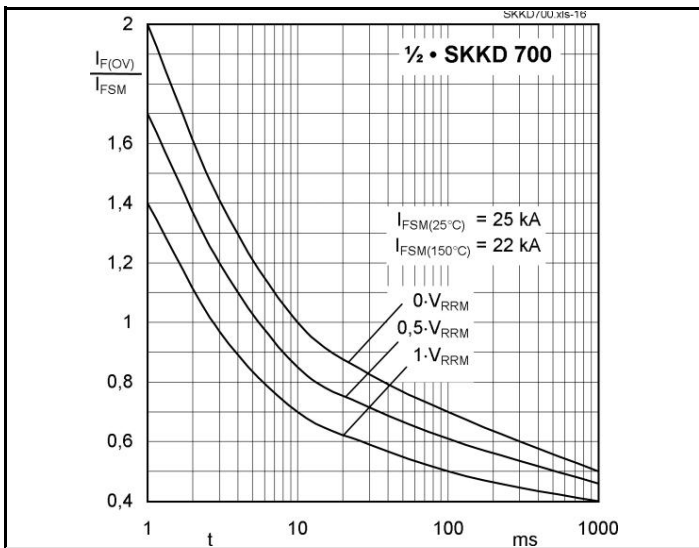
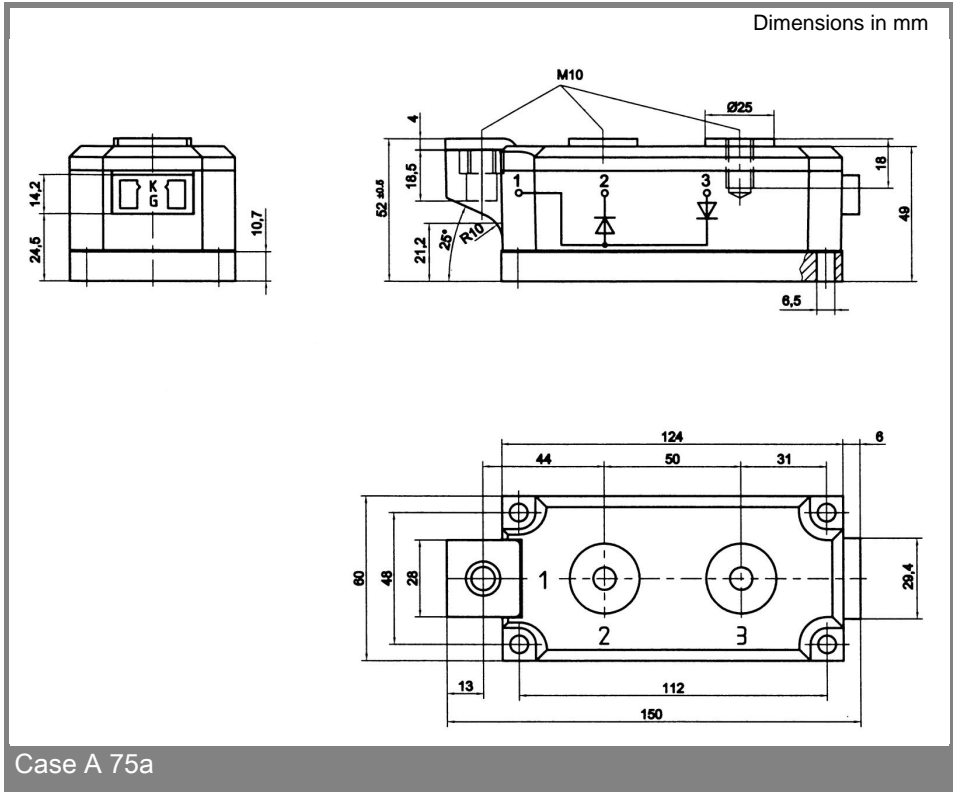

Fig. 16 Surge overload current vs. time



Case A 75a

This technical information specifies semiconductor devices but promises no characteristics. No warranty or guarantee expressed or implied is made regarding delivery, performance or suitability.