

Antiparallel Thyristors with Isolated Water Flow

SKIW 700
SKIW 900

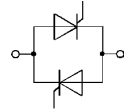

Features

- Compact units containing two high current thyristors connected in antiparallel
- Internal insulation between thyristors and cooling media via aluminium oxyde (AlO₂)
- All plastic material used carries Underwriters Laboratories flammability classification 94V-0

Typical Applications

- Large resistance welding equipment
- Large electroplating equipment

V_{DRM} V_{RSM} V_{RRM} V	$I_{RMS}^{1)}$ ($V_{olw} = 4$ l/min., $T_w = 40$ °C, ED = 50 %, n = 10)	
	850 A	1200 A
1200	SKIW 700/12	SKIW 900/12
1400	SKIW 700/14	SKIW 900/14
1600	SKIW 700/16	SKIW 900/16

Symbol	Conditions	SKIW 700	SKIW 900
$I_{RMS}^{1)}$	$V_{olw} = 4$ l/min, $T_w = 40$ °C, ED = 100 %	700 A	900 A
I_{TSM}	$T_{vj} = 40$ °C; 10 ms $T_{vj} = 125$ °C; 10 ms	7 000 A 6 000 A	10 000 A 8 500 A
i^2t	$T_{vj} = 40$ °C; 8,3 ... 10 ms $T_{vj} = 125$ °C; 8,3 ... 10 ms	245 000 A ² s 180 000 A ² s	500 000 A ² s 360 000 A ² s
$(di/dt)_{cr}$ $(dv/dt)_{cr}$	f = 50 ... 60 Hz $T_{vj} = 125$ °C		125 A/μs 200 V/μs
t_q	$T_{vj} = 125$ °C; typ.		150 μs
I_H	$T_{vj} = 25$ °C		200 mA
I_L	$T_{vj} = 25$ °C; $R_G = 33$ Ω		600 mA
V_T	$T_{vj} = 25$ °C; ($I_T = \dots$); max.	1,65 V (500 A)	1,45 V (800 A)
$V_{T(TO)}$	$T_{vj} = 125$ °C	1,0 V	1,0 V
r_T	$T_{vj} = 125$ °C	0,7 mΩ	0,5 mΩ
V_{GT}	$T_{vj} = 25$ °C	3 V	
I_{GT}	$T_{vj} = 25$ °C	200 mA	
V_{GD}	$T_{vj} = 125$ °C	0,25 V	
I_{GD}	$T_{vj} = 125$ °C	10 mA	
R_{thjw}	$V_{olw} = 4$ l/min	0,175 °C/W	0,14 °C/W
T_{vj}	max.	125 °C	
T_{stg}	min. ... max.	5 ... 85 °C	
V_{ISOL}	a.c. 50 Hz; r.m.s.; 1 min	2500 V~	
M_2	SI units / US units	20 Nm / 180 lb. in.	
p_w	max.	10 bar	
w		1,3 kg	
Case		C 1	

¹⁾ For $V_{olw} = 2$ l/min and $T_w = 30$ °C the same I_{RMS} values apply

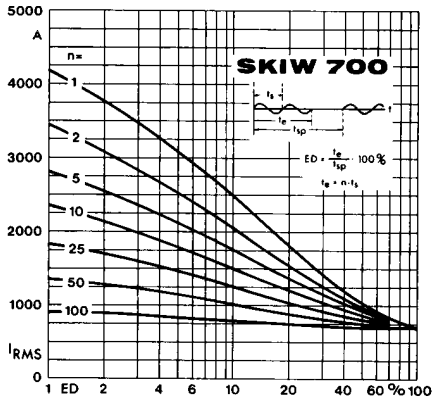

Fig. 1 a Rated rms current vs. duty cycle

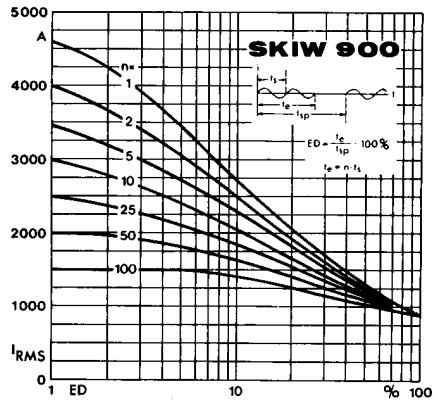

Fig. 1 b Rated rms current vs. duty cycle

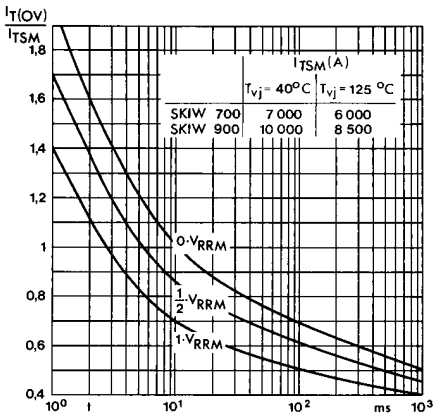

Fig. 2 Surge overload current vs. time

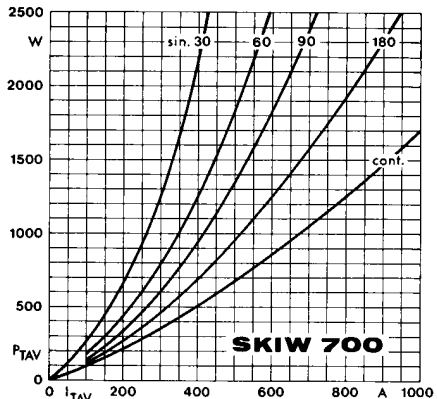

Fig. 3 a Power dissipation vs. mean on-state current

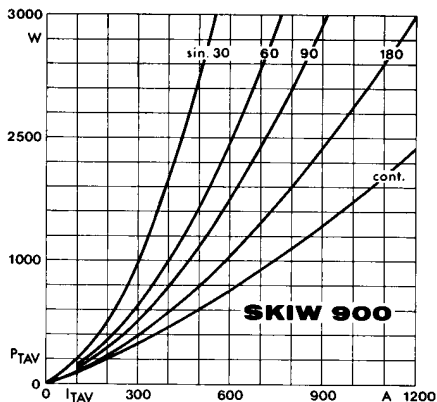

Fig. 3 b Power dissipation vs. mean on-state current

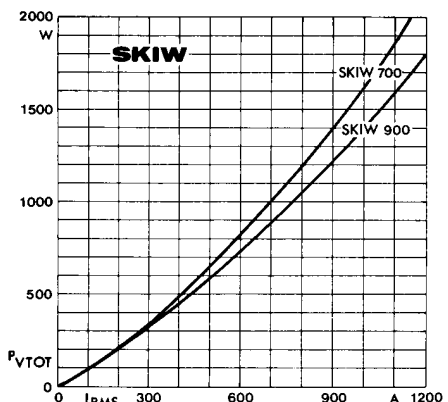

Fig. 4 Power dissipation vs. rms on-state current

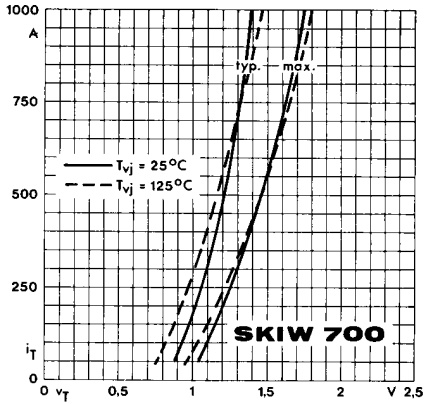

Fig. 5 a On-state characteristics

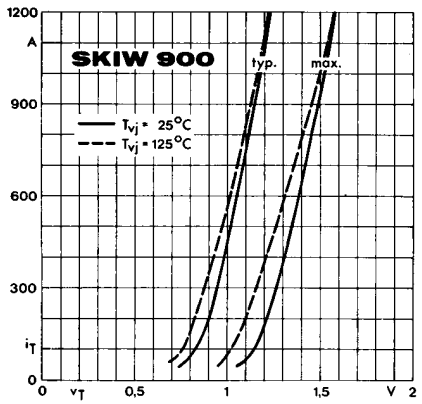

Fig. 5 b On-state characteristics

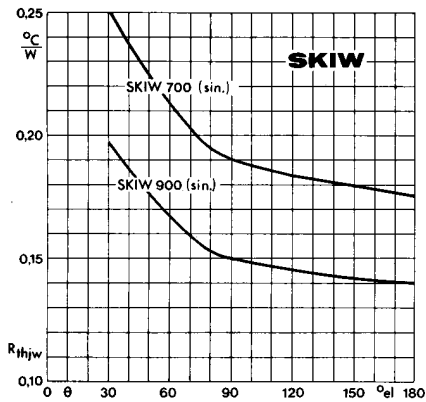

Fig. 6 Thermal resistance vs. conduction angle

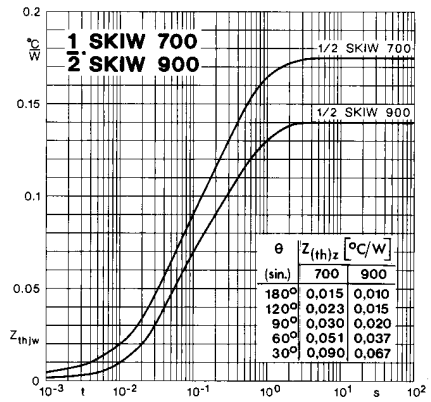

Fig. 7 Transient thermal impedance vs. time

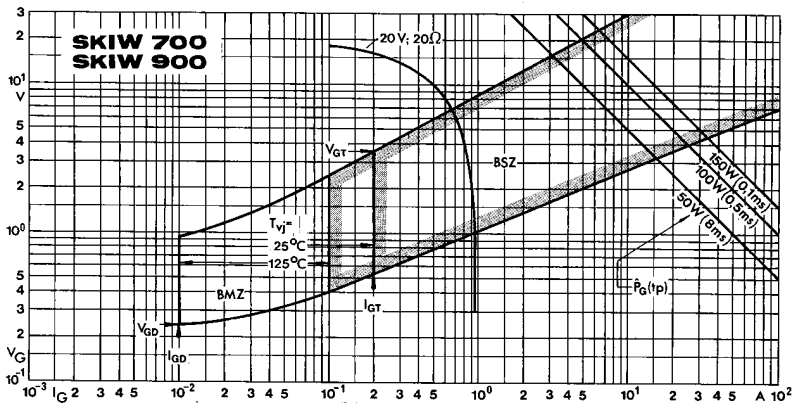
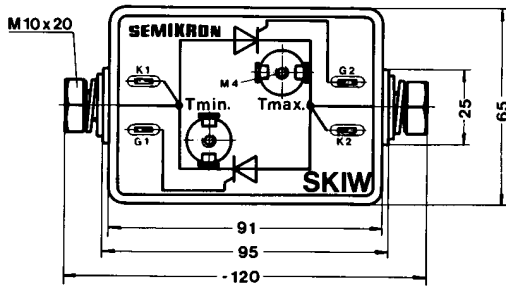
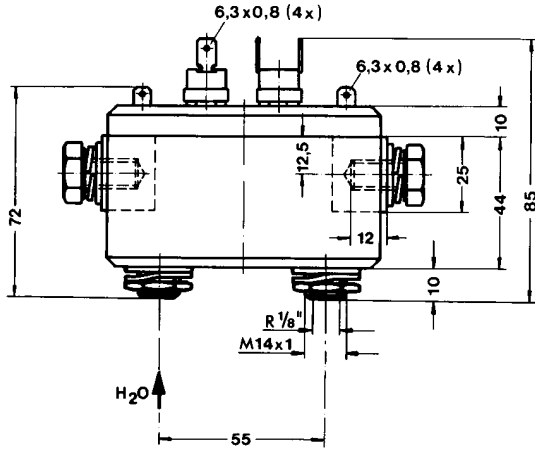

Fig. 8 Gate trigger characteristics

SKIW 700
SKIW 900
Case C 1



Dimensions in mm