



SEMIPONT[®] 1

Controllable Bridge Rectifiers

SKBZ 28

Features

- Sturdy isolated metal baseplate
- Fast-on terminals with solder tips
- Suitable for wave soldering
- High surge current rating
- UL recognized, file no. E 63 532

Typical Applications*

- Controllable single phase rectifier
- DC power supplies
- DC motor controllers
- DC motor field controllers

- 1) Painted metal shield of minimum 250 x 250 x 1 mm: $R_{th(c-a)} = 1,85 \text{ K/W}$
- 2) Freely suspended or mounted on insulator

| V_{RSM} V | V_{RRM}, V_{DRM} V | $I_D = 28 \text{ A (full conduction)}$ ($T_c = 89 \text{ °C}$) |
|----------------|-------------------------|---|
| 400 | 400 | SKBZ 28/04 |
| 600 | 600 | SKBZ 28/06 |
| 800 | 800 | SKBZ 28/08 |
| 1200 | 1200 | SKBZ 28/12 |
| 1400 | 1400 | SKBZ 28/14 |

| Symbol | Conditions | Values | Units |
|--------------------|--|----------------|------------------|
| I_D | $T_c = 85 \text{ °C}$ | 30 | A |
| | $T_a = 45 \text{ °C; chassis } ^1)$ | 13 | A |
| | $T_a = 45 \text{ °C; P5A/100}$ | 15 | A |
| | $T_a = 45 \text{ °C; P13A/125}$ | 16 | A |
| | $T_a = 45 \text{ °C; P1A/120}$ | 23 | A |
| I_{TSM}, I_{FSM} | $T_{vj} = 25 \text{ °C; } 10 \text{ ms}$ | 320 | A |
| | $T_{vj} = 125 \text{ °C; } 10 \text{ ms}$ | 280 | A |
| i^2t | $T_{vj} = 25 \text{ °C; } 8,3 \dots 10 \text{ ms}$ | 510 | A ² s |
| | $T_{vj} = 125 \text{ °C; } 8,3 \dots 10 \text{ ms}$ | 390 | A ² s |
| V_T | $T_{vj} = 25 \text{ °C; } I_T = 75 \text{ A}$ | max. 2,25 | V |
| $V_{T(TO)}$ | $T_{vj} = 125 \text{ °C;}$ | max. 1 | V |
| r_T | $T_{vj} = 125 \text{ °C}$ | max. 16 | mΩ |
| I_{DD}, I_{RD} | $T_{vj} = 125 \text{ °C; } V_{DD} = V_{DRM}; V_{RD} = V_{RRM}$ | max. 8 | mA |
| t_{gd} | $T_{vj} = 25 \text{ °C; } I_G = 1 \text{ A; } di_G/dt = 1 \text{ A/}\mu\text{s}$ | 1 | μs |
| t_{gr} | $V_D = 0,67 \cdot V_{DRM}$ | 1 | μs |
| $(dv/dt)_{cr}$ | $T_{vj} = 125 \text{ °C}$ | max. 500 | V/μs |
| $(di/dt)_{cr}$ | $T_{vj} = 125 \text{ °C; } f = 50 \text{ Hz}$ | max. 50 | A/μs |
| t_q | $T_{vj} = 125 \text{ °C; typ.}$ | 80 | μs |
| I_H | $T_{vj} = 25 \text{ °C; typ. / max.}$ | 50 / 150 | mA |
| I_L | $T_{vj} = 25 \text{ °C; } R_G = 33 \text{ }\Omega$ | 100 / 300 | mA |
| V_{GT} | $T_{vj} = 25 \text{ °C; d.c.}$ | min. 2 | V |
| I_{GT} | $T_{vj} = 25 \text{ °C; d.c.}$ | min. 100 | mA |
| V_{GD} | $T_{vj} = 125 \text{ °C; d.c.}$ | max. 0,25 | V |
| I_{GD} | $T_{vj} = 125 \text{ °C; d.c.}$ | max. 3 | mA |
| $R_{th(j-c)}$ | per thyristor / diode | 1,8 | K/W |
| | total | 0,45 | K/W |
| | total ²⁾ | 0,1 | K/W |
| $R_{th(c-s)}$ | | 15 | K/W |
| $R_{th(j-a)}$ | | | K/W |
| T_{vj} | | - 40 ... + 125 | °C |
| T_{stg} | | - 40 ... + 125 | °C |
| V_{isol} | a. c. 50 Hz; r.m.s.; 1 s / 1 min. | 3600 (3000) | V |
| M_s | case to heatsink | 2 | Nm |
| M_t | | n.a. | Nm |
| m | | 66 | g |
| Case | SKBZ | G 24 | |

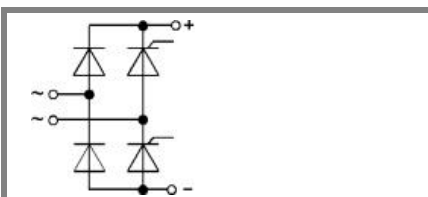

SKBZ

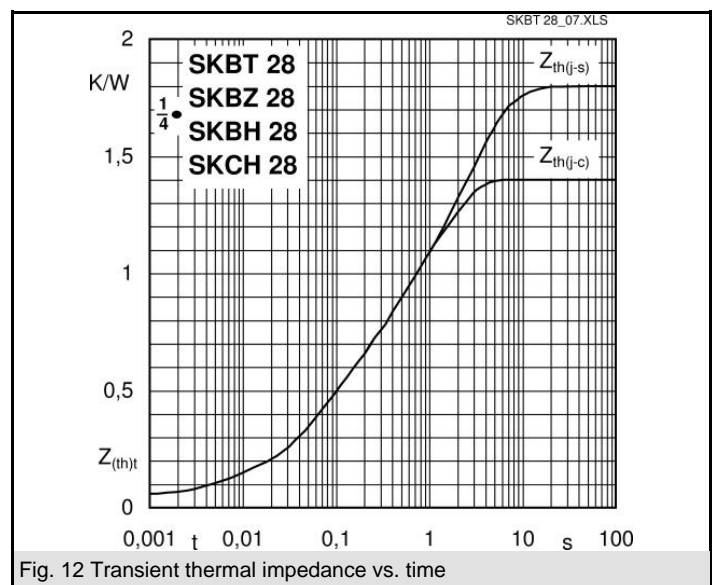
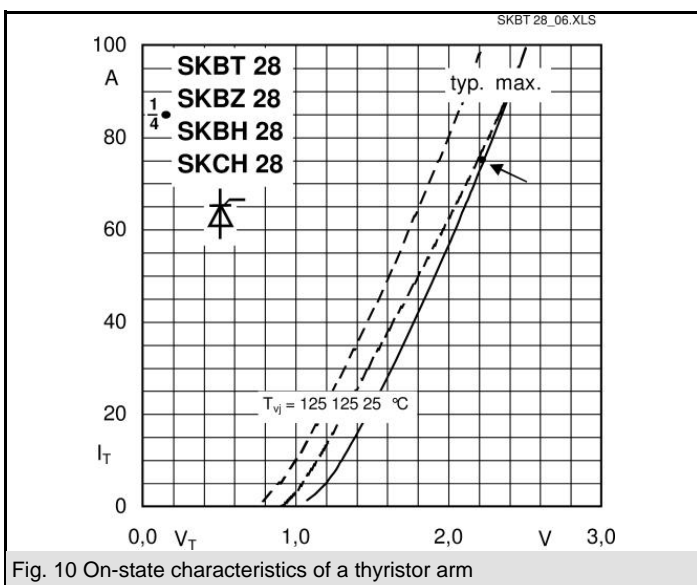
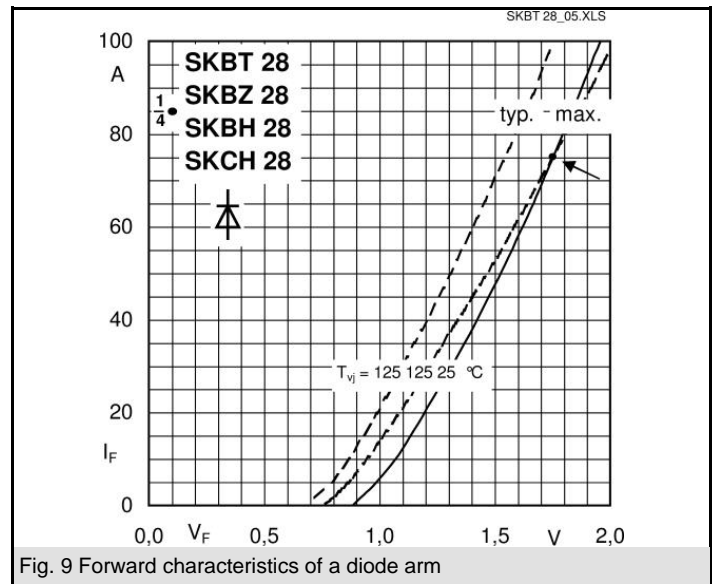
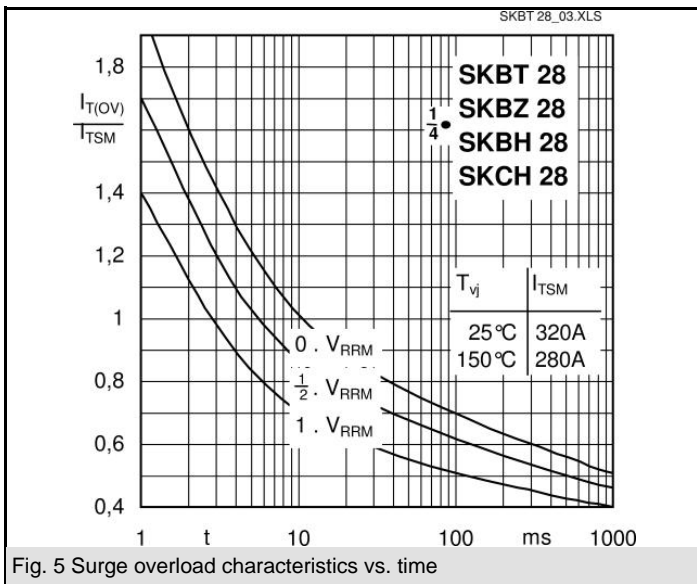
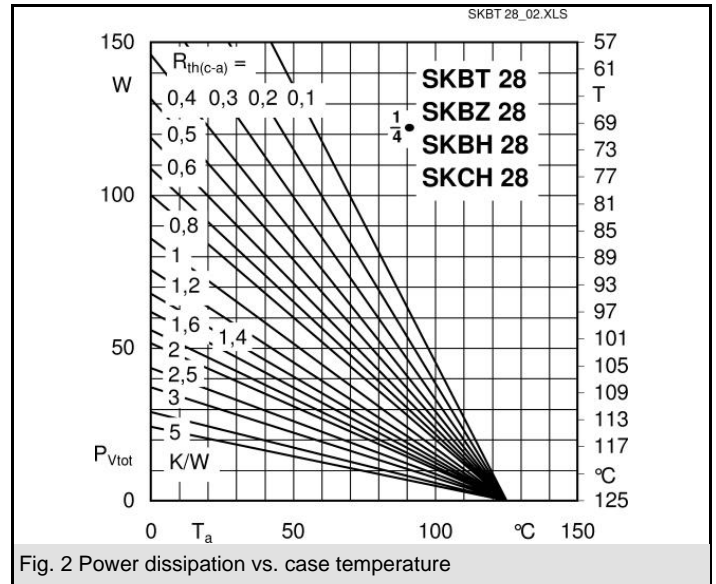
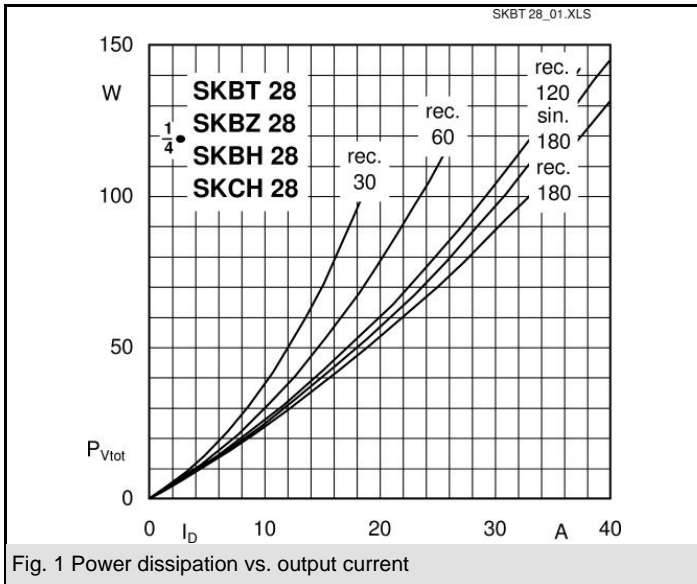

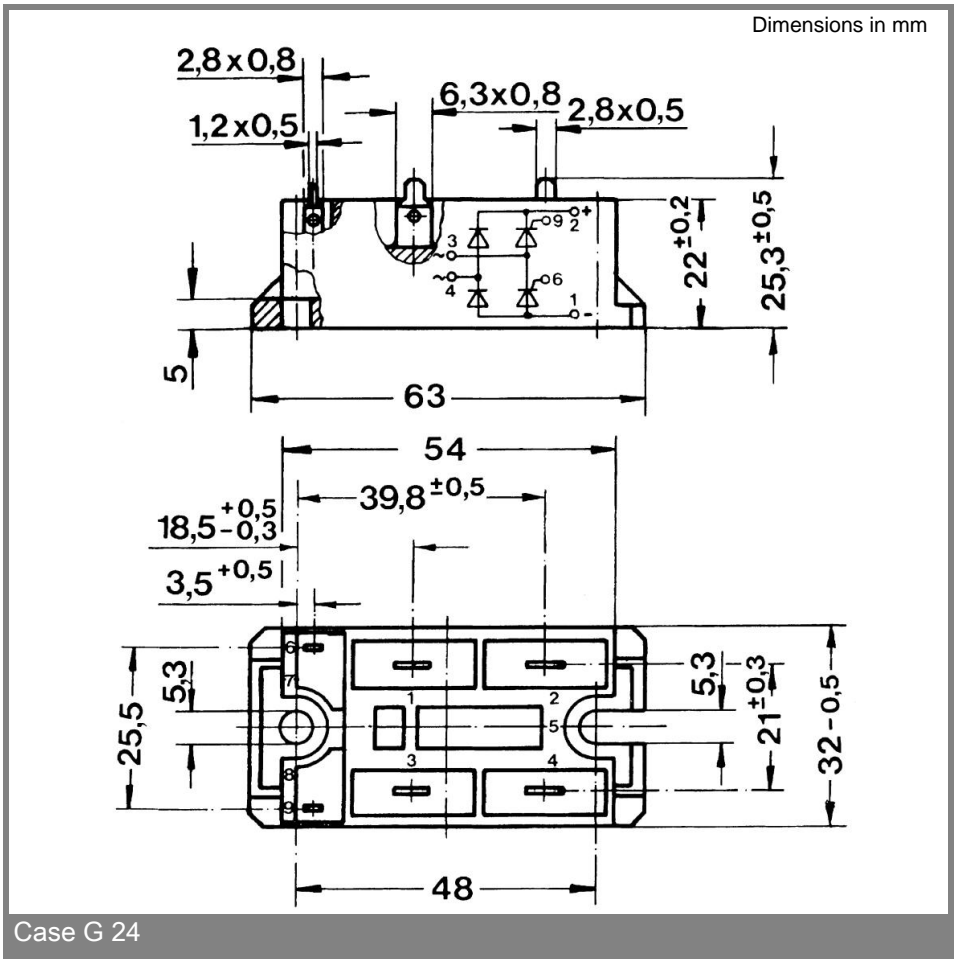
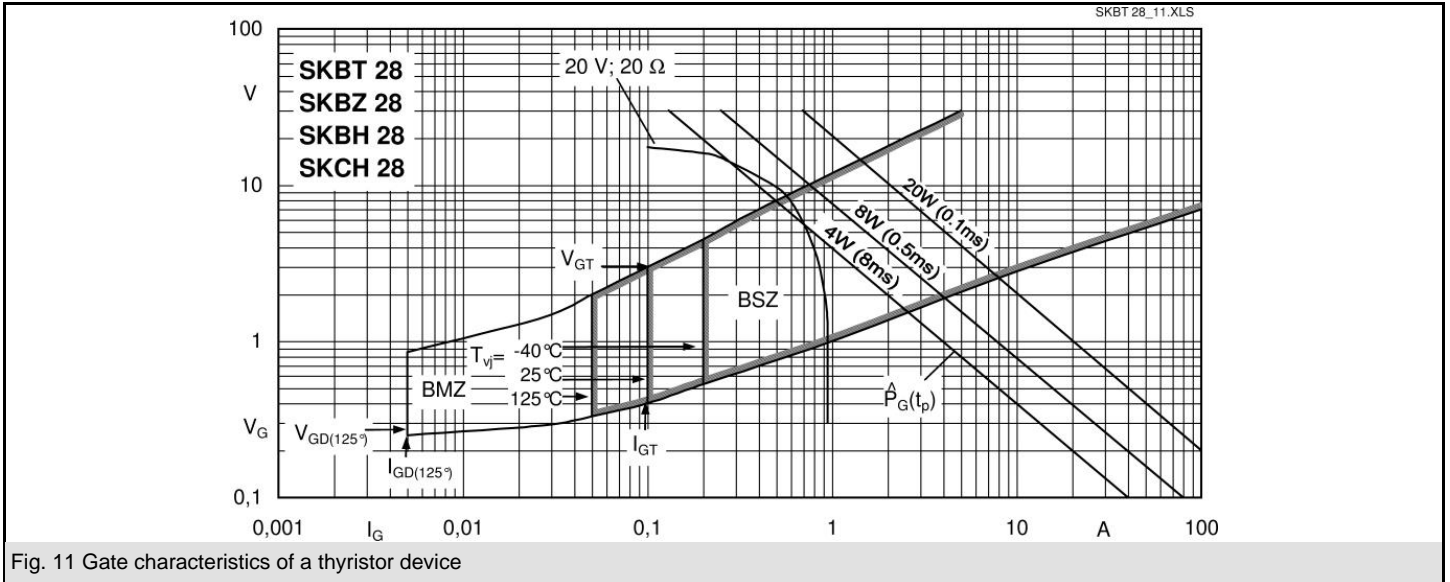

* The specifications of our components may not be considered as an assurance of component characteristics. Components have to be tested for the respective application. Adjustments may be necessary. The use of SEMIKRON products in life support appliances and systems is subject to prior specification and written approval by SEMIKRON. We therefore strongly recommend prior consultation of our personal.