



FEATURES:

- 6000 VDC Isolation
- Low Profile DIP 16 Package
- Industry Standard Pinout
- MTBF>3,500,000 hours
- Unregulated Single Output Models
- Operating Temperature: -40°C to +105°C
- High Efficiency up to 81%
- RoHS Compliant



Models Single output

Model	Input Voltage (V)	Output Voltage (V)	Output Current max (mA)	Isolation (VDC)	Efficiency (%)
AM2B-0505SH60-NZ	4.5-5.5	5	400	6000	77
AM2B-0512SH60-NZ	4.5-5.5	12	167	6000	81
AM2B-0515SH60-NZ	4.5-5.5	15	133	6000	80
AM2B-1205SH60-NZ	10.8-13.2	5	400	6000	77
AM2B-2405SH60-NZ	21.6-26.4	5	400	6000	78
AM2B-2415SH60-NZ	21.6-26.4	15	133	6000	80

NOTE: All specifications in this datasheet are measured at an ambient temperature of 25°C, humidity<75%, nominal input voltage and at rated output load unless otherwise specified.

Input Specifications

Parameters	Nominal	Typical	Maximum	Units
Voltage range	5	4.5-5.5		VDC
	12	10.8-13.2		
	24	21.6-26.4		

Isolation Specifications

Parameters	Conditions	Typical	Rated	Units
Tested I/O voltage	60 sec		6000	VDC
Capacitance	500VDC	10		pF
Resistance		>1000		MOhm

Output Specifications

Parameters	Conditions	Typical	Maximum	Units
Voltage accuracy	See Tolerance Graph	±5		%
Short circuit protection		Continuous		
Short Circuit restart		Auto Recovery		
Line voltage regulation	For a 1% change of Vin	±1.2		%
Load voltage regulation	From 10% load to 100% load	12		%
Temperature coefficient	At 100% load	±0.03		%/°C
Ripple & Noise*	20MHz Bandwidth	150		mV p-p
Minimum load current**		10		% of Max

* Test ripple & noise by "Parallel Cable Method" as described in Application Note "Ripple and Noise Measurement of Brick & POL DC-DC Converters" available at www.aimtec.com

** If the operating output current is less than 10% of maximum it is recommended to install a load resistor in parallel with the load to ensure the actual load current meets the minimum load current requirement.

General Specifications

Parameters	Conditions	Typical	Maximum	Units
Switching frequency	100% load, nominal input	50		KHz
Operating temperature		-40 to + 85		°C
Storage temperature		-55 to + 125		°C
Maximum case temperature			100	°C
Cooling	Free Air Convection			
Humidity			95	% RH

General Specifications (continued)

Parameters	Conditions	Typical	Maximum	Units
Case material	Plastic(UL94-V0)			
Weight	3.8			g
Dimensions (L x W x H)	0.94 x 0.60 x 0.32 inches		23.86 x 15.24 x 8.00mm	
MTBF	> 3,500,000 hours (MIL-HDBK -217F, Ground Benign, t=+25°C)			
Maximum soldering temperature	1.5mm from case for 10 seconds		300	°C

Safety Specifications

Parameters	
Agency approvals	CE
Standards	EN 60601-1-1; EN 60601-1-2

Pin Out Specifications

Pin	Single
1	- V in
2	No Pin
3	No Pin
4	No Pin
5	No Pin
6	No Pin
7	NC
8	NC
9	+V out
10	-V out
11	No Pin
12	No Pin
13	No Pin
14	No Pin
15	No Pin
16	+V in

NC: not connected

Load Accuracy Tolerance Graph

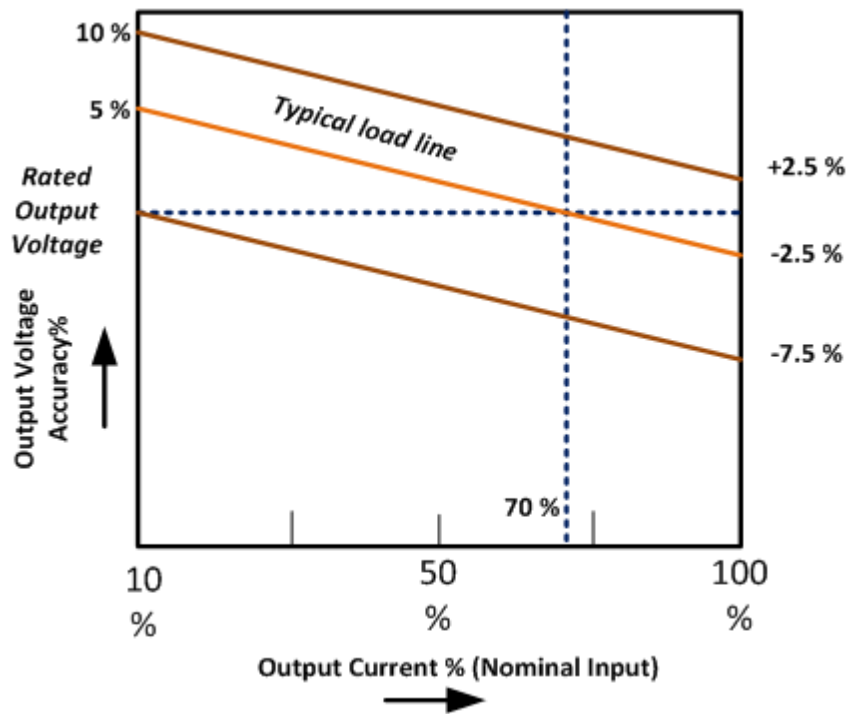

Typical Efficiency Example Charts

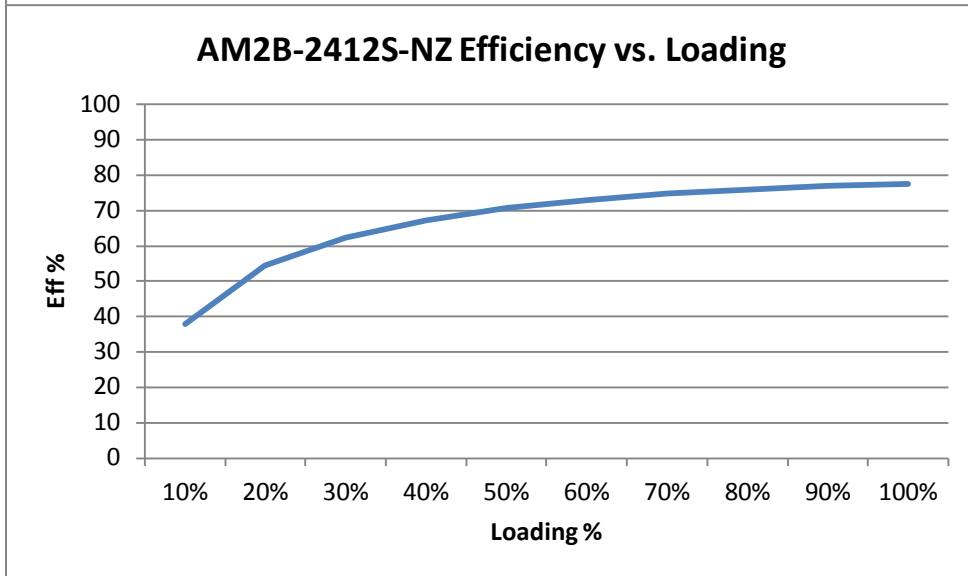
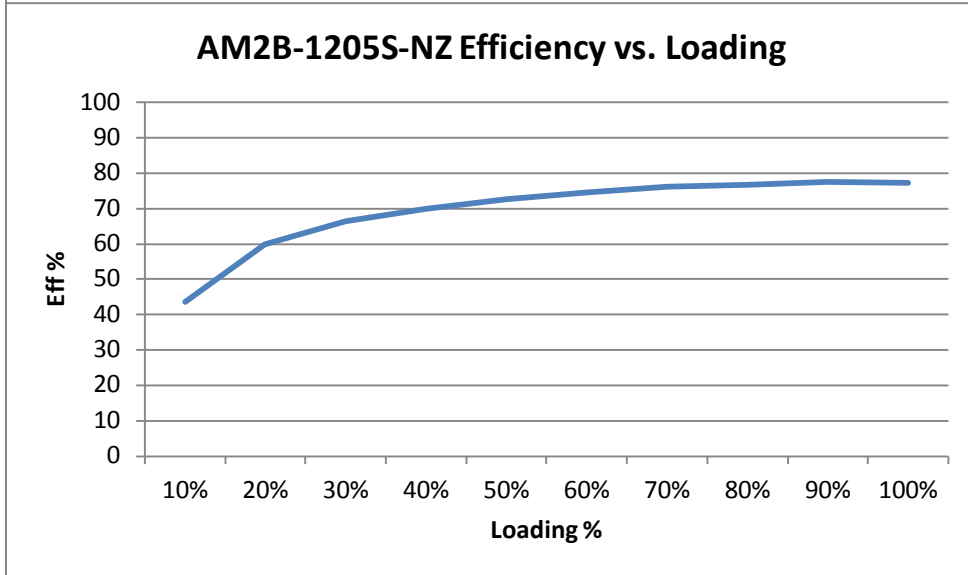
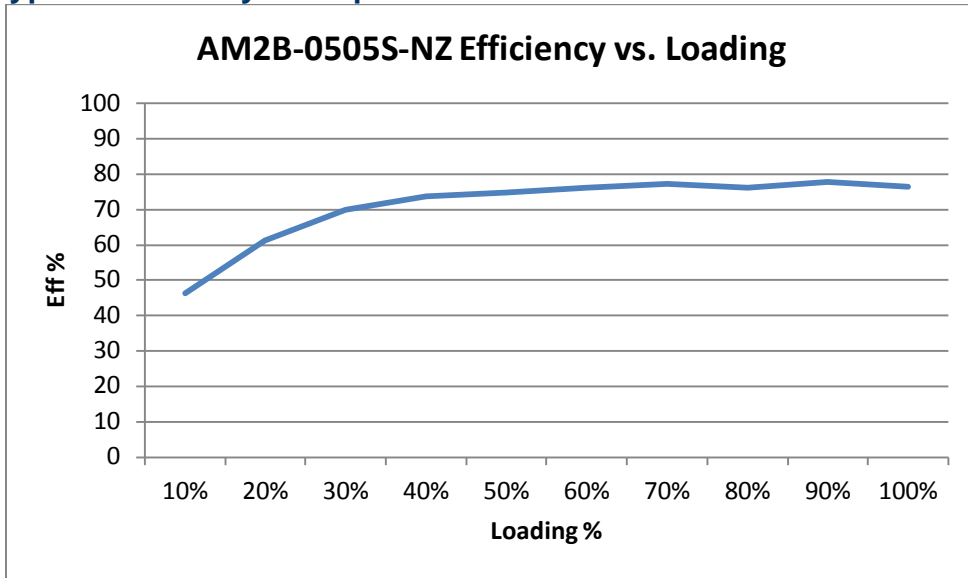

Dimensions

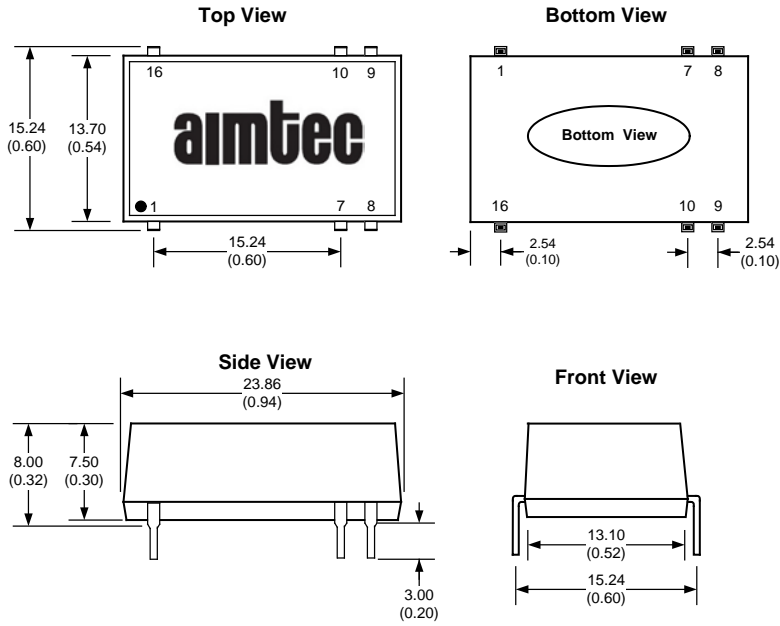

Derating

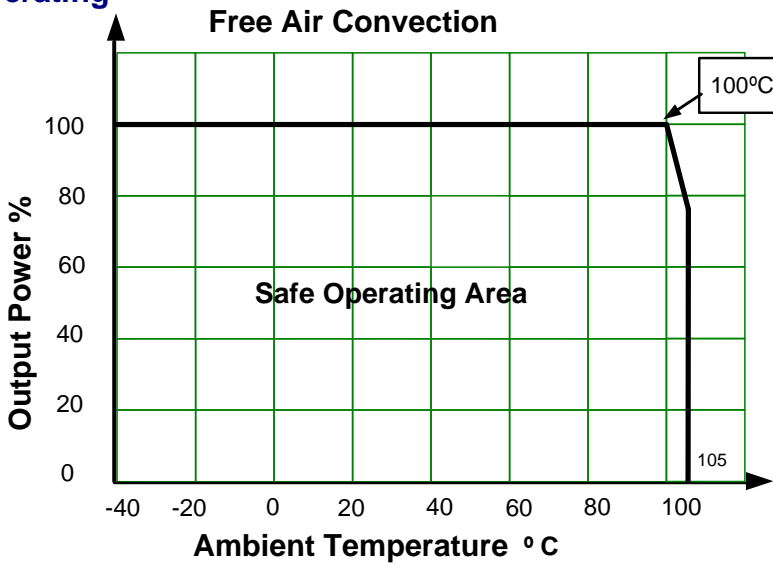

Recommended Filter Circuit

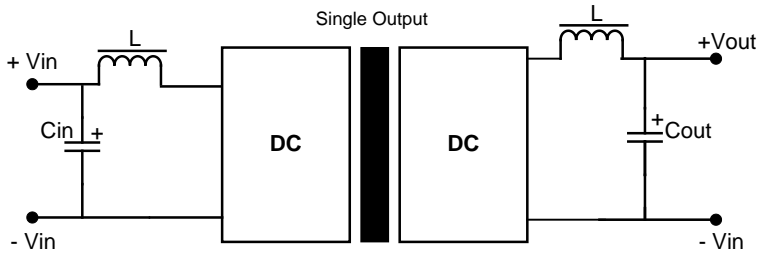

If it is required to decrease the input/output ripple an “LC” filter network can be installed on the input and output of the converter (see above).

It should be noted that the inductance and the resonant frequency of the “LC” filtering network should differ from the DC/DC converter switching frequency to avoid mutual interference.

The capacitance of the output filter capacitor must not exceed the values in the Table below to avoid startup problems and ensure safe and reliable operation.

It's not recommended to connect any external capacitor in the application field when output loading is less than 0.5 watt.

External Capacitor Tables

Input Capacitor (Cin)

Vin (VDC)	Cin (uF)
5	4.7
12	2.2
24	1

Output Capacitor (Cout)

Single Vout (VDC)	Cout (uF)
5	10
12	2.2
15	1

NOTE: 1. Datasheets are updated as needed and as such, specifications are subject to change without notice. Once printed or downloaded, datasheets are no longer controlled by Aimtec; refer to www.aimtec.com for the most current product specifications. 2. Product labels shown, including safety agency certifications on labels, may vary based on the date manufactured. 3. Mechanical drawings and specifications are for reference only. 4. All specifications are measured at an ambient temperature of 25°C, humidity<75%, nominal input voltage and at rated output load unless otherwise specified. 5. Aimtec may not have conducted destructive testing or chemical analysis on all internal components and chemicals at the time of publishing this document. CAS numbers and other limited information are considered proprietary and may not be available for release. 6. This product is not designed for use in critical life support systems, equipment used in hazardous environments, nuclear control systems or other such applications which necessitate specific safety and regulatory standards other the ones listed in this datasheet. 7. Warranty is in accordance with Aimtec's standard Terms of Sale available at www.aimtec.com.