

Surface Mount Voltage Controlled Oscillator

JTOS-1000W+

Wide Band 500 to 1000 MHz

Features

- wide frequency range, 500 to 1000 MHz typ.
- 3 dB modulation bandwidth 100 kHz typ.
- octave, linear tuning
- low phase noise, -134 dBc/Hz at 1 MHz offset, typ.
- excellent harmonic suppression, -26 dBc typ.
- aqueous washable

Applications

- test instruments-signal generators
- wideband frequency synthesizers
- agile communications systems
- catv distribution and set-top converters
- cellular up and down converters
- digital cordless phones

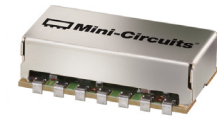

CASE STYLE: BK377

+RoHS Compliant

The +Suffix identifies RoHS Compliance. See our web site for RoHS Compliance methodologies and qualifications

Electrical Specifications

FREQUENCY (MHz)	POWER OUTPUT (dBm)	TUNING VOLTAGE (V)	PHASE NOISE (dBc/Hz)				PULLING pk-pk @ 12 dB (MHz)	PUSHING (MHz/V)	TUNING SENSITIVITY (MHz/V)	HARMONICS (dBc)		3 dB MODULATION BANDWIDTH (MHz)	DC OPERATING POWER		
			SSB at offset frequencies: Typ.							Typ.	Max.		Vcc (volts)	Current (mA) Max.	
Min.	Max.	Typ.	Min.	Max.	1 kHz	10 kHz	100 kHz	1 MHz	Typ.	Typ.	Typ.	Max.	12	25	
500	1000	+7.0	1.0	18	-73	-94	-114	-134	5.0	1.0	30-40	-26	-20	0.1	25

Pin Connections

RF OUT	13
VCC	2
V-TUNE	5
GROUND	1,3,4,6,7,8,9,10,11,12,14

Maximum Ratings

Operating Temperature	-55°C to 85°C
Storage Temperature	-55°C to 100°C
Absolute Max. Supply Voltage (Vcc)	+15V
Absolute Max. Tuning Voltage (Vtune)	+25V

all specifications: 50 ohm system
Permanent damage may occur if any of these limits are exceeded.

Outline Drawing

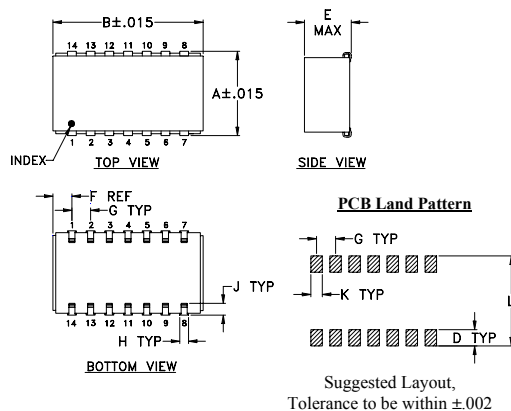

Demo Board MCL PIN: TB-04 Suggested PCB Layout (PL-005)

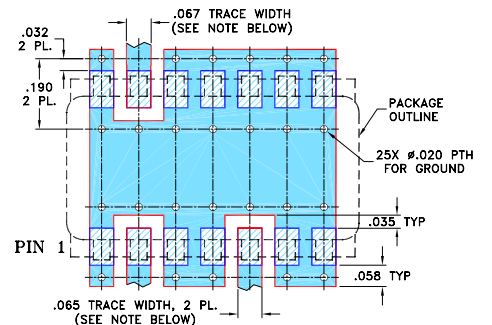

Outline Dimensions (inch/mm)

A	B	C	D	E	F	G	H	J	K	L	wt
.505	.800	--	.100	.250	.100	.100	.047	.065	.065	.525	grams
12.83	20.32	--	2.54	6.35	2.54	2.54	1.19	1.65	1.65	13.34	3.0

Notes

- Performance and quality attributes and conditions not expressly stated in this specification document are intended to be excluded and do not form a part of this specification document.
- Electrical specifications and performance data contained in this specification document are based on Mini-Circuit's applicable established test performance criteria and measurement instructions.
- The parts covered by this specification document are subject to Mini-Circuits standard limited warranty and terms and conditions (collectively, "Standard Terms"); Purchasers of this part are entitled to the rights and benefits contained therein. For a full statement of the Standard Terms and the exclusive rights and remedies thereunder, please visit Mini-Circuits' website at www.minicircuits.com/MCLStore/terms.jsp



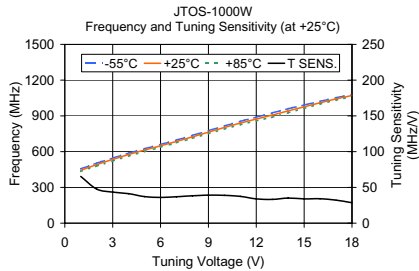

V TUNE	TUNING SENS. (MHz/V)	FREQUENCY (MHz)			POWER OUTPUT (dBm)		
		-55°C	+25°C	+85°C	-55°C	+25°C	+85°C
1.00	65.31	455.40	443.44	433.76	6.26	6.25	5.53
2.00	47.64	503.88	491.08	480.00	7.39	7.21	6.47
3.00	43.38	546.43	534.46	521.76	7.47	8.06	7.56
4.00	41.23	587.53	575.68	562.24	8.20	8.54	8.16
5.00	37.18	624.47	612.87	600.23	8.46	8.97	8.85
6.00	36.00	660.47	648.87	636.80	9.22	9.54	9.03
7.00	36.98	697.54	685.84	673.93	9.70	10.08	9.64
8.00	38.32	736.41	724.17	711.94	9.07	9.62	9.84
9.00	39.19	775.71	763.36	750.82	8.72	9.58	9.46
10.00	38.93	815.33	802.29	789.02	8.02	8.68	8.60
11.00	37.42	854.60	839.71	825.08	8.08	8.58	8.42
12.00	33.97	889.31	873.67	857.98	7.57	8.27	7.99
13.00	33.20	925.48	906.87	889.55	6.77	7.37	7.23
14.00	35.13	960.60	942.00	925.73	5.90	6.70	6.35
15.00	33.97	991.30	975.97	963.00	5.27	5.88	5.37
16.00	34.17	1022.17	1010.14	999.00	5.11	5.44	4.99
17.00	32.21	1052.63	1042.35	1031.78	4.35	5.25	5.01
18.00	28.65	1081.03	1070.99	1060.58	3.80	4.85	4.62

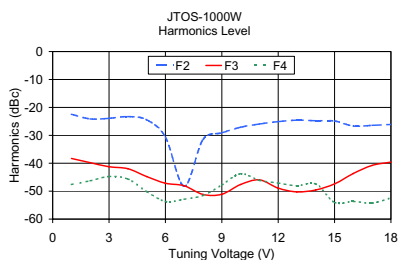
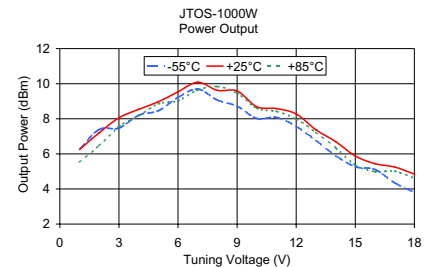

V TUNE	HARMONICS (dBc)			FREQ. PUSHING (MHz/V)
	F2	F3	F4	
1.00	-22.44	-38.27	-47.61	0.10
2.00	-24.11	-39.78	-46.28	0.05
3.00	-23.91	-41.25	-44.75	0.04
4.00	-23.27	-41.94	-45.61	0.19
5.00	-24.44	-44.78	-50.11	0.51
6.00	-30.66	-47.16	-53.66	0.70
7.00	-48.22	-48.05	-52.89	0.88
8.00	-31.50	-51.17	-51.50	1.12
9.00	-29.10	-51.10	-47.76	1.38
10.00	-27.10	-47.60	-43.77	1.43
11.00	-25.95	-45.95	-46.12	1.57
12.00	-25.08	-48.92	-47.08	1.71
13.00	-24.57	-50.24	-48.07	1.85
14.00	-24.75	-49.58	-47.41	1.75
15.00	-24.87	-47.37	-54.03	1.38
16.00	-26.67	-43.67	-53.67	1.19
17.00	-26.42	-40.76	-54.26	1.09
18.00	-26.09	-39.59	-52.42	0.97

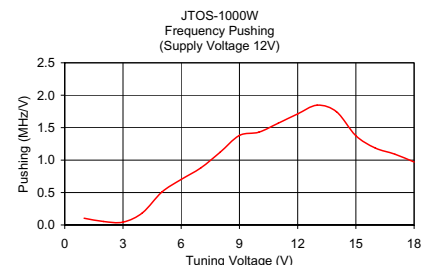

Notes

- A. Performance and quality attributes and conditions not expressly stated in this specification document are intended to be excluded and do not form a part of this specification document.
- B. Electrical specifications and performance data contained in this specification document are based on Mini-Circuit's applicable established test performance criteria and measurement instructions.
- C. The parts covered by this specification document are subject to Mini-Circuits standard limited warranty and terms and conditions (collectively, "Standard Terms"); Purchasers of this part are entitled to the rights and benefits contained therein. For a full statement of the Standard Terms and the exclusive rights and remedies thereunder, please visit Mini-Circuits' website at www.minicircuits.com/MCLStore/terms.jsp

